

## AD DESTINATUM VI | 2009–2018

The period that framed this sixth volume in the *Ad Destinatum* series was marked by several significant events and developments, among which was the appointment of the Prof Cheryl de la Rey, the 12th Vice-Chancellor and Principal of the University of Pretoria. The purpose of each volume in the series is to serve as a reference resource of a specific time period, and over time, to capture the unique circumstances that have shaped the University's identity and academic project. In this volume, we set out to trace and reconstruct major institutional developments during the period, 2009 to 2018, which coincided with the development of the University's long-term strategy, UP 2025. Three themes tie together the six chapters: leadership and the dynamic nature of change; the University's *time-place* situatedness, simultaneously in Africa and in a global 21st century knowledge world; and thirdly, the need continually to recalibrate and realign strategies in order for intentional change to become embedded.

# AD DESTINATUM VI

2009–2018

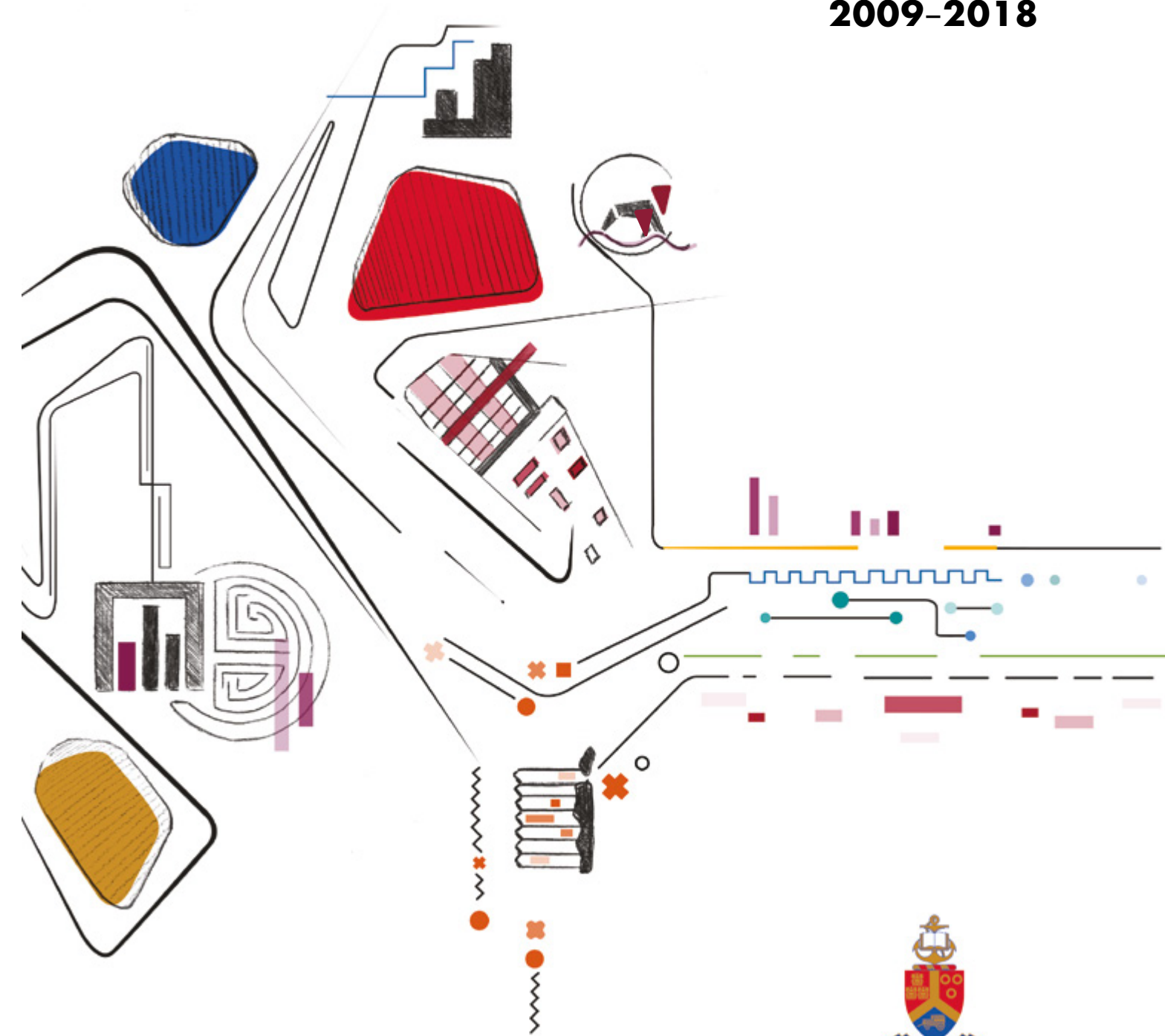
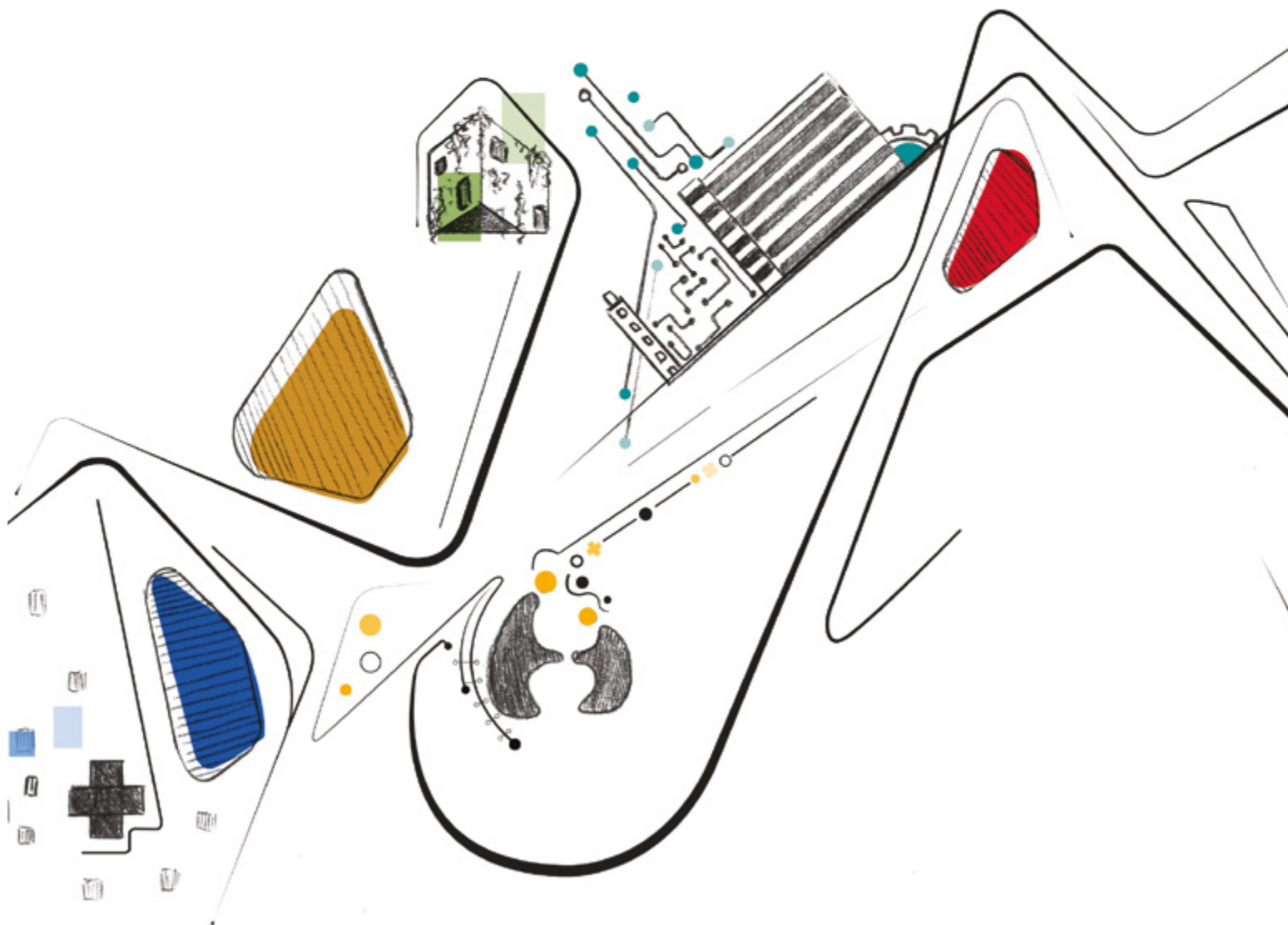

[www.up.ac.za](http://www.up.ac.za)



UNIVERSITEIT VAN PRETORIA  
UNIVERSITY OF PRETORIA  
YUNIBESITHI YA PRETORIA

**Ad Destinatum VI**  
2009–2018

# Ad Destinatum VI

## 2009–2018

Tracing developments in the history of the University of Pretoria

Editors | **Hanlie Griesel and James Ogude**



UNIVERSITEIT VAN PRETORIA  
UNIVERSITY OF PRETORIA  
YUNIBESITHI YA PRETORIA

Published by the University of Pretoria  
[www.up.ac.za/archives](http://www.up.ac.za/archives)  
Copyright © University of Pretoria, 2023

The publication is in copyright. All rights reserved. No part of this publication may be reproduced, stored in a retrieval system or transmitted in any form or by any means, electronic or mechanical, including photocopying, recording or otherwise, without prior written permission of the copyright owners.

Photo credits: EyeScape and individual credits, where indicated.

Design and layout: Sanet du Plessis  
Cover design: Marcholette Minnaar  
Copy-editing and proofreading: Dr Berene Kramer and Dr Bronwyn Strydom  
ISBN: 978-1-77592-253-7 (E-Book)



## Preface

The period that framed this sixth volume in the *Ad Destinatium* series was marked by several significant events and developments, among which was the appointment of the 12th Vice-Chancellor and Principal of the University of Pretoria, Prof Cheryl de la Rey. The purpose of each volume is to serve as a reference resource of a specific time period, and over time, to reflect the unique circumstances that have shaped the University's identity and academic project. In this volume, we set out to trace and reconstruct major institutional developments during the period 2009 to 2018, which coincided with this leadership era.

The challenge was accurately and authentically to capture this timeframe, so that each chapter would be nested in an overall narrative that tells the story of the University. In addition to the texts, we intentionally included images that speak to this time. In broad terms, the structure of *Ad Destinatium VI* follows the following contours: Chapter 1 sets the context with respect to the higher education landscape and the imperatives of transformation. This is followed, in Chapter 2, by an overview of governance, from the UP Council as the apex structure, to the Executive and Senior Management, and the Office of the Registrar. Chapter 3 provides detail on the University's long-term strategic plan, UP 2025, and its implementation. Significant were the 'navigational markers' that became inscribed in the long-term strategy — and the deliberate positioning for the University to pursue a research-intensive identity.

The focus of Chapter 4, by far the longest chapter in the volume, is on academic identity. It includes the contributions of the nine faculties, the business school, and the Mamelodi Campus, and significant developments during the review period. Chapter 5 includes the contributions of the professional service departments that support and underpin the strategic direction of the University, while Chapter 6 points to the future. As noted here, this final chapter brings together a number of research institutes, centres and hubs that are essentially research platforms that attract scholars way beyond the borders of the University and have contributed in situating UP as an African university with a global provenance and relevance.

What distinguished specific eras in the history of institutions is a matter that we closely considered throughout the development of this publication. The *time-place* situatedness of UP, for example, was one of the binding ideas where UP's

intentional strategy and actions were necessarily entailed in local realities and, at the same time, a 21st century world where knowledge production has become the global currency of universities. However, while the profile of students, and to some degree staff, had changed radically, this could not in all instances be said of institutional culture and practices. Transformation and, more particularly, the voice of students became cross-cutting themes, from the cover design of this volume to the views captured in Chapter 1 on the tumultuous #FeesMustFall movement, and the curriculum transformation that marked this period in the history of the University of Pretoria, reflected in Chapter 4.

A third theme that helped to give coherence to the at times disparate content, and in fact echoed an institutional refrain, was the need to build on areas of research strength and to increase institutional capacity in order to have an impact on society and to make a difference. As we have noted, while this was perhaps not new in the history of the University, the commitment most certainly was enacted in new ways, ranging from branding and advocacy campaigns of 'make today matter' and 'research that matters', to the recognition that the University's spheres of potential influence were many and multi-dimensional. It seems accurate to say that the long-term strategy, UP 2025, positively framed the role and actions of the University and, in this period, helped to strengthen its identity and distinguish it from other universities, in Africa and in the rest of the world.

### ACKNOWLEDGEMENTS

With a project of this magnitude, there is invariably a long list of credits that include people without whose contributions this publication would not have materialised. First, members of the editorial board and the chairperson, Prof Caroline Nicholson; in alphabetic order, Prof Karen Harris, Prof Gerald Ouma, Prof Maxi Schoeman, Edwin Smith and Dr Ria van der Merwe. Secondly, the engine room of the project and the administrative assistance provided by postgraduate students; in the first year, by Nirvaly Mooloo, followed by Anamika Anamallay. Thanks are also due to UP Archives, and especially Ria van der Merwe for her input, and the Department of Institutional Planning, for HEMIS data and analysis; in particular, Hugo Mouton and colleagues Papama Somgede, Carolyn Kriel and Carel Venter. A special word of thanks to Simla Bhawanipersad who printed reams of trees for the purposes of proofreading and authors' corrections;

and to Elize Nagel for her work on the indexes. Thirdly, the copy editors and proofreaders; Dr Berene Kramer for her scrutiny of the different layers of writing and editing of all the contributions received — and for staying the course; and Jonathan Tager for his editing of Chapter 5. Dr Bronwyn Strydom, at the very end of the project, ensured that all t's were crossed and i's dotted. Also, our gratitude to Michelle Viljoen who compiled information on transformation and the content that formed the substance of Chapter 2 on governance. In the background, as seems invariably to be the case, was the support received from the Office of the Vice-Chancellor and Principal, the Registrar's Office and the Secretariat; a special word of thanks to Elana van Vreden who kept the ball in court, and our gratitude to Elmarie Cronje, Elzanie Slabbert and Gerda Langenhoven.

**Students' contribution** to the design of this publication demand specific mention. Early in the process, we approached Prof Duncan Reyburn, the coordinator of the Information Design programme in the School of Visual Arts, who involved third-year students in a design competition for *Ad Destinatum*

VI that formed part of their curriculum and assessment. Ten students received merit awards for their designs, and the winner of the competition, Marchollette Minnaar, then stepped into big shoes. In addition to her cover design, she remained part of the project for its duration — from designing the infographics to curating images, contributing to the layout and implementing author's corrections. We are pleased that her efforts were recognised and accredited as an internship. Also, our appreciation to Sanet du Plessis for her design and layout, and keeping in balance creativity, skill and patience.

There is always a boss (or bosses) in projects of this scale, therefore finally, our sincere thanks to Prof Nicholson for her time and wise counsel, the Deans and Directors who contributed texts and provided feedback, and the University of Pretoria for having made it possible to trace this history.

**Hanlie Griesel and James Ogude**

*Editors, Ad Destinatum VI*

## Contents

- Preface
- Tables and figures
- Messages
- CHAPTER 1 | Context 1
- CHAPTER 2 | Governance 29
- CHAPTER 3 | UP 2025 Strategy 57
- CHAPTER 4 | Academic identity 103
- CHAPTER 5 | Environment and support 415
- CHAPTER 6 | Looking to the future 501
- References 534
- Appendices 538
- Abbreviations and acronyms 559
- Index 566

*l to r (back): Prof Caroline Nicholson, Prof Maxi Schoeman, Dr Ria van der Merwe, Prof James Ogude  
(front): Edwin Smith, Hanlie Griesel, Prof Karen Harris*

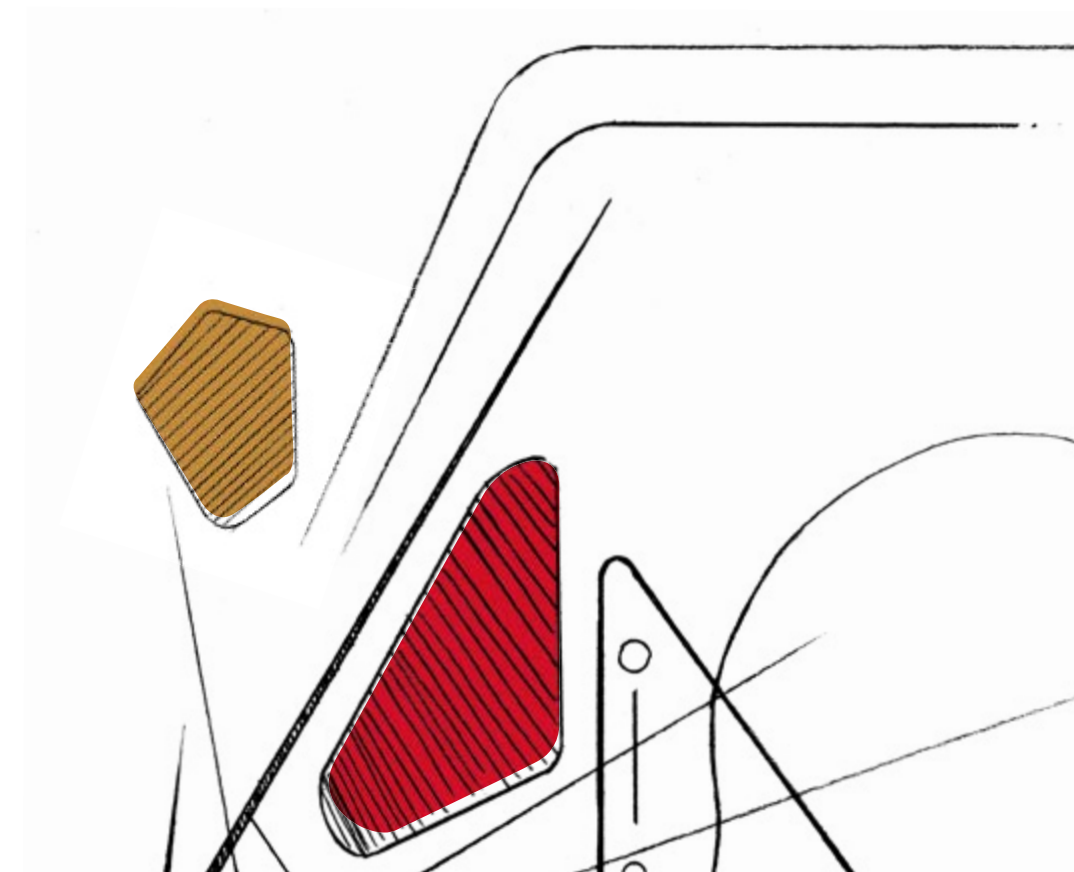

## Tables and figures

### TABLES

Table 1.1	Public higher education headcount enrolments by race, 2009 to 2018
Table 1.2	University of Pretoria headcount enrolment per race, 2009 to 2018
Table 1.3	UP graduates per major field of study, 2009 and 2018
Table 3.1	UP student diversity headcount enrolment, 2009 and 2018
Table 3.2	UP international student headcount enrolment, 2009 to 2018
Table 3.3	FTE undergraduate module pass rates, 2009 to 2018
Table 3.4	Average undergraduate module pass rates for contact students, 2012 to 2018
Table 3.5	UP contact and distance mode graduates, 2009 to 2018
Table 3.6	Key areas of research capacity and performance, 2012 and 2017–2018
Table 3.7	UP research output units per publication type, 2012 to 2018
Table 3.8	UP's comparative position in weighted research output, 2009 to 2018
Table 3.9	UP's international standing in ESI knowledge fields
Table 4.1	Comparison of student numbers in EBIT between 2009 and 2018
Table 4.2	Health Sciences student enrolment and throughput, 2009 to 2018
Table 4.3	Faculty of Veterinary Science profile of students, 2009 to 2018
Table 5.1	Percentage increase in student fees between 2009 and 2018
Table 5.2	Scholarship and loan awards for 2009
Table 5.3	Scholarship and loan awards for 2018
Table 5.4	UP intellectual property activity from 2009 to 2018

### FIGURES

Figure 1.1	Comparison between UP income streams for the years ended 31 December 2009 and 31 December 2018
Figure 2.1	Governance structures of the University of Pretoria
Figure 3.1	UP 2025 nested planning model
Figure 3.2	UP 2025 internal differentiation
Figure 3.3	UG and PG headcount enrolment, contact students, 2009 to 2018
Figure 3.4	UG graduates and percentage black graduates, 2009 to 2018
Figure 3.5	PG graduates and percentage black graduates, 2009 to 2018
Figure 3.6	UG graduates and percentage female graduates, 2009 to 2018
Figure 3.7	UG graduates and percentage female graduates, 2009 to 2018
Figure 3.8	FTE undergraduate module pass rates, 2009 to 2018
Figure 3.9	UP's comparative position in weighted research output, 2009 to 2018
Figure 3.10	UP's increase in the percentage of co-authored papers, 2009 to 2018
Figure 3.11	UP's field citation impact performance, 2009 to 2018
Figure 3.12	Increase in the number of papers in Q1, 2009 to 2018
Figure 4.1	Faculty of Theology and Religion research output, 2010 to 2018

## Messages

### From the Chancellor

Universities are important institutions that promote social and economic development and, indeed, the well-being of societies. In post-apartheid South Africa, the public higher education sector, and individual institutions, have played an important role in strengthening our young democracy and the culture of critical citizenry necessary for nurturing the values of social justice.

I had the distinct privilege to be the Chancellor of the University of Pretoria for the entire period that is the focus of this sixth volume in the *Ad Destinatum* series, spanning the years 2009 to 2018 and the leadership era of Prof Cheryl de la Rey as Vice-Chancellor and Principal. It was during this period that the University developed its long-term strategic plan for 2025 that soon came to be referred to simply as UP 2025. Approved by the UP Council in November 2011, the strategy set out clear guidelines and priority actions that framed much of the University's subsequent academic endeavours through the core missions of research, education and engagement.

There were, and undoubtedly will continue to be, many occasions when I took and will have great pride in the achievements of one of South Africa's finest universities — ranging from graduation ceremonies to world rankings and collaboration, and the many awards and accolades received by staff and students for the academic excellence in teaching and learning, research, creative outputs and the arts, and on the sports fields where individuals and teams excelled. This does not mean that we did not have moments of apprehension; on the contrary, there were periods of



deep contestation and introspection. These too have become part of the institutional memory, and the identity and development of a university that stands proud among its national and international peers.

I have no doubt that next generations of leaders — among staff, students and the executive — will build on the lessons learned in the achievements and challenges alike in what was a memorable period in the history of the University of Pretoria.

**Prof Wiseman Nkuhlu** | Chancellor of the University of Pretoria

## From the Chairperson of Council

Institutional governance, and the role of University Councils, had been in the spotlight since the work undertaken by the National Commission on Higher Education in the mid-1990s that paved the way for the 1997 *White Paper: A programme for the transformation of higher education*; and subsequently, the 2013 *White Paper for post-school education and training*. Much work needed to be done to meet the goals set for the transformation of the higher education system in South Africa; and Councils, as the apex oversight body of universities, had to play a significant role in this change process.

There were important, and frequently urgent matters in the review period 2009 to 2018 that demanded the full attention of Council and the leadership of the University of Pretoria. Notable were the difficult years following the #FeesMustFall student protests which started in 2015 and soon engulfed the entire higher education sector. Linked to this sea change in higher education that strained the sustainability of all universities, was the change in language policy at the University of Pretoria that marked a further imprint on the identity of the University. In this period, the UP Council held a number of special meetings in addition to the scheduled meetings and the annual workshop, the latter usually held in September to discuss the University's strategic priorities.

By 2018, the Minister of Higher Education and Training, Dr Blade Nzimande, had placed several universities and the National Student Financial Aid Scheme (NSFAS) under administration. That the University of Pretoria remained stable throughout this period, bears testimony to the strong leadership within the University and the good work of Council and its committees in fulfilling their intended governance role.

It is also important to foreground UP's growth and development in this review period; the diversity and profile of students who enrolled and succeeded changed dramatically,



research outputs and impact strengthened, and there were major expansions on each of the University's campuses which Council considered and for which capital expenditure was approved. In line with the campus master plan, infrastructural development in this period — which included the major developments of Future Africa, the Javett-UP Art Centre and Engineering 4.0. — ensured that the University of Pretoria could compete with the best in the world.

In hindsight, the UP Council ensured that the University was well-governed fiscally and that its financial position was probably the best among South African universities. It was my privilege to serve the University of Pretoria as Chairperson of Council from 2008. Indeed, UP continued to benefit from visionary leaders who, each in their unique way, have paved the way for the University to be proudly anchored in Africa.

**Futhi Mtoba** | Chairperson of the UP Council

## From the Vice-Chancellor

History has the curious habit of being remembered differently by individuals and groups, and just as well: recorded and carried forward, it provides the archives (and counter-archives) that open to further scrutiny major events and developments that have taken place over time. The University of Pretoria has had a remarkable history of record-keeping, from the early days when it was founded, in 1908, as the Transvaal University College, to the present.

My tenure at UP started in November 2009, a year after the University's centenary celebrations. We were midway through the strategic plan 2007–2011 and soon started with discussions and the work of task teams that centred on the development of a long-term strategy for the University for the next 15 years. UP 2025, as it came to be known, provided the framework for guiding the University to achieve its vision as a university in Africa, inspired and driven by the continent's aspirations and challenges. Shorter one- and five-year planning cycles within this long-term vision and plan would allow us fully to exploit the vibrancy and responsiveness of the University, realign priorities and make it possible to harness the dynamic nature of change. Our lodestars were, from the onset, quality, diversity, responsiveness and sustainability.

This volume in the *Ad Destinatum* series illustrates the scope of activity, from governance to students and staff, faculties and service departments, and the platforms established to strengthen collaboration and position the University of Pretoria to engage in a complex nexus of problems, which invariably require multi- and transdisciplinary approaches for effective resolution. The research platforms briefly described in the concluding chapter of the volume point to some of the major achievements in this regard. I am particularly proud of the groundwork laid in making Future Africa, Engineering 4.0, and the Javett-UP Art Centre part of the legacy of this era in the history of the University of Pretoria. Each in their own right has become an example of engagement and frontier research that illustrate what can be achieved when the collective resolve is to make a difference.

There were many high points in the nine years that spanned the period 2009 to 2018, and predictably also challenges and upheavals that required strong leadership. The Executive team ensured, through their leadership and portfolios, that institutional stability was maintained both in turbulent times and periods of relative calm, and that, over time, a new equilibrium could be reached — such is the nature of change, and of strong leaders.



In my inaugural address, delivered in April 2010 in the capacity as the new Vice-Chancellor and Principal of the University of Pretoria, I outlined what I believed could be achieved and the contours of a roadmap for the University into the future. I invited the university community to 'imagine UP in 2025'. *Ad Destinatum VI* is a reference resource that bears testimony to what subsequently materialised as the long-term strategy of the University, UP 2025.

I thank Prof Caroline Nicholson, Registrar and chairperson of the *Ad Destinatum VI* editorial committee, members of the editorial committee, and the editors, Hanlie Griesel and Prof James Ogude, for their immense contribution to this record of a period in the history of the University of Pretoria. Histories do not only have a curious way of being remembered differently, histories are also uncertain. As Hilary Mantel famously observed, history should be written pointing forward: "Remember that the people you are following didn't know the end of their own story... they were going forward day by day, pushed and jostled by circumstances, doing the best they could ..."<sup>1</sup>

I have immensely vivid recollections of the time I spent at the helm of the University of Pretoria and sincerely wish that this historic record will be of value for generations to come, and be read and used as an authentic reflection of an environment in which we had hoped students and staff would thrive.

**Prof Cheryl de la Rey** | Vice-Chancellor and Principal

<sup>1</sup> <https://www.washingtonpost.com/obituaries/2022/09/23/hilary-mantel-wolf-hall-novelist-dead/>

# Context

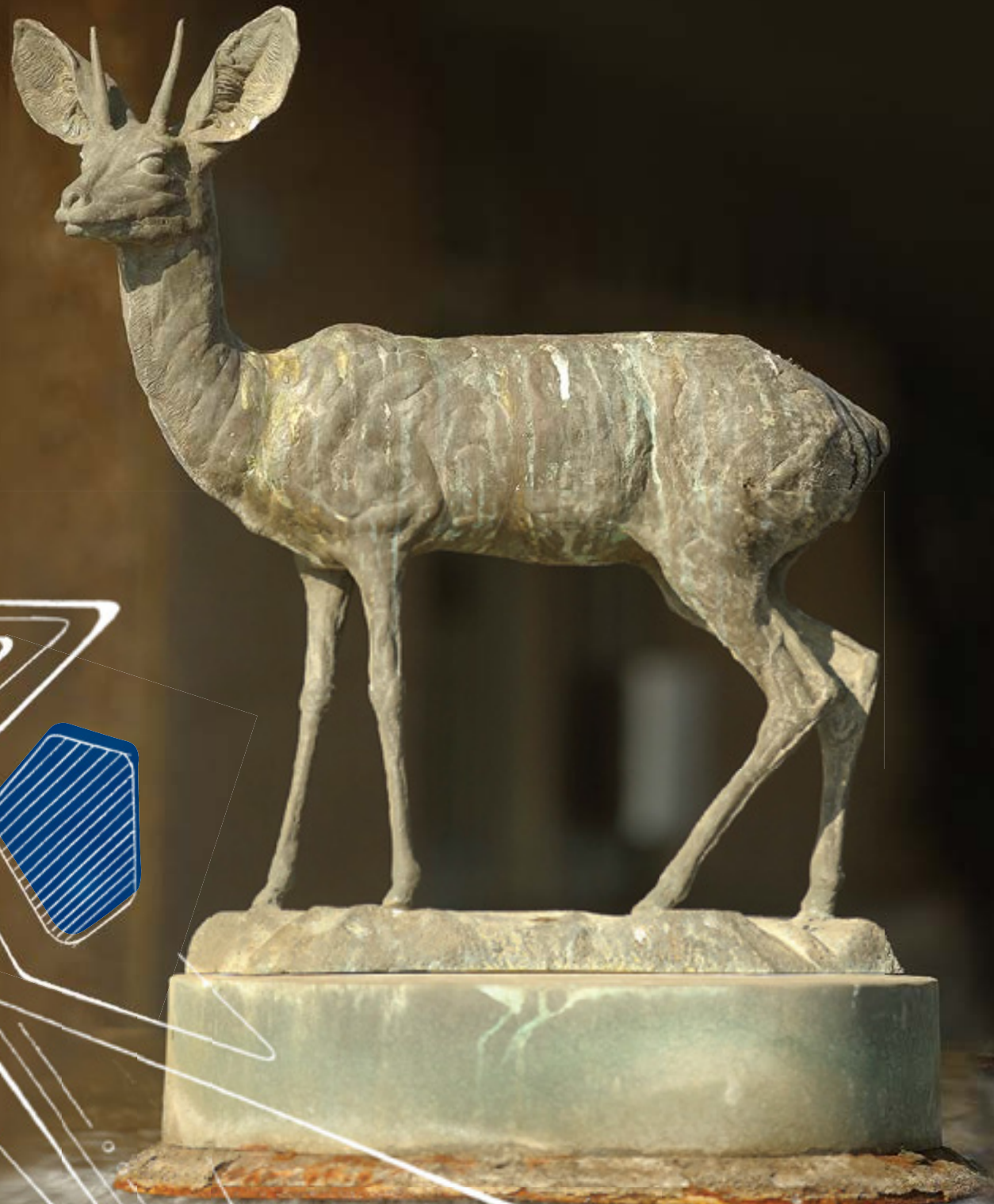

Credit: Lucinda du Toit

- 1. New leadership era
- 2. Higher education in South Africa
- 3. The cornerstones of UP 2025
- 4. Higher education funding — an institutional perspective
- 5. Transformation

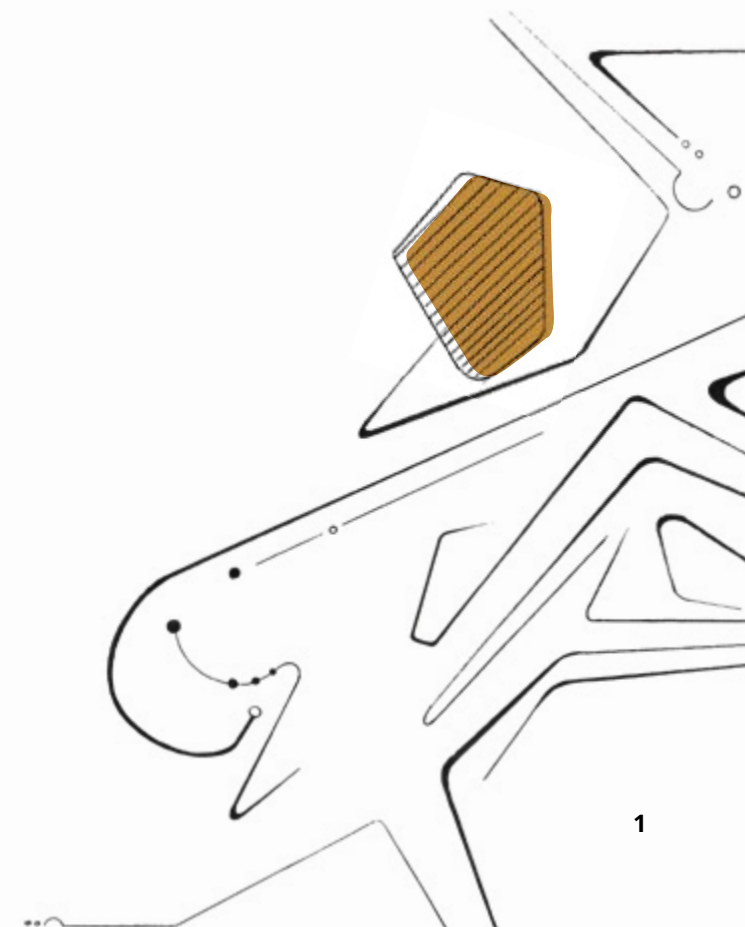





# 1 | A new leadership era

The purpose of the *Ad Destinatum* volumes, held in the UP Archives, is to serve as a historic record of major institutional developments within specific timeframes. Each volume reflects the unique circumstances that shaped the institution's identity and academic project during the period under review. The sixth volume in the series is structured to capture the contextual catalysts that framed the period 2009 to 2018, and the leadership era of Prof Cheryl (CM) de la Rey as Vice-Chancellor and Principal of the University of Pretoria.

The *Ad Destinatum VI* review period, 2009 to 2018, spans an era of renewed focus on the role of universities and the three missions of research, education and service, and their interrelated purposes. In the context of South Africa's young democracy, the urgency was for universities, and education more broadly, to contribute to building a just society, socio-economic development, societal transformation and substantive democratisation.<sup>1</sup> While there remained a recurrent focus on the 'private good' of universities for individuals, the emphasis continually returned to the 'public good', given the many and complex challenges faced by societies and the widely held expectation that universities must contribute to finding sustainable solutions.<sup>2</sup>

Globally, and in tandem with the massification of higher education, the emergence of a knowledge-driven economy and society was accelerated by the rapid expansion of information and communication technology. Often regarded as one of the most enduring institutions in the world, universities found themselves in uncharted territory, where their relevance and agility were tested. It was clear that, into the future, universities would be recognised for the ways in which they responded to, harnessed and managed the challenges of their contexts, and that these contexts would, in turn, directly shape the role of universities.

At the University of Pretoria, the appointment of Prof De la Rey as Vice-Chancellor and Principal in mid-2009 followed on the University's centenary celebrations in 2008. Prof De la Rey took office in November 2009, at the cusp of the development of a new long-term strategic plan for the institution. The strategy, soon to be known as UP 2025,<sup>3</sup> was central in shaping the thematic content and focus of *Ad Destinatum VI* and the many ways in which UP's identity as a university on African soil was strengthened during this leadership era.



Prof Cheryl de la Rey, Vice-Chancellor and Principal 2009–2018

<sup>1</sup> TM Luescher. 2007. Higher education and the substantiation of democracy in South Africa. Report on the research seminar of the Higher Education Institutional Autonomy and Academic Freedom (HEIAAF) Task Team. Johannesburg.

<sup>2</sup> M Singh. 2001. Re-inserting the 'public good' into higher education transformation. *Kagisano Dialogue Series*, No1, 8-18. Council on Higher Education, Summer 2001.

<sup>3</sup> University of Pretoria. 2011. Strategic Plan: The vision, mission and plan of the University for 2025. (See Appendix A.)

Prof De la Rey was the first black and first female Vice-Chancellor and Principal of UP, and her appointment marked a significant turning point and new era in the development and transformation of the University.

### Policy development

The university system in South Africa had experienced a time of intensive policy formulation from the earlier 1990s, which culminated in the 1997 *White Paper 3, A Programme for the Transformation of Higher Education*<sup>4</sup> and the Higher Education (HE) Act of 1997.<sup>5</sup> While there have been a number of amendments to the HE Act, the *White Paper* remained a guiding policy framework for close to two decades. The major thrust of this policy framework was on transforming a grossly unequal system of access, provision, and knowledge production and dissemination. The second *White Paper*, published in 2013,<sup>6</sup> addressed the entire post-school education and training system and signalled a shift in focus to building an integrated post-school education and training system of which universities were one sector.

During this time, much has been written about the era of policy development in South Africa and the system restructuring and institutional alignment that were required, as a consequence. The National Education Policy Investigation (NEPI) in the early 1990s laid the foundation for the National Commission on Higher Education (NCHE). The NEPI investigation involved all areas of education, from early childhood to post-secondary and adult basic education. A project of the National Education Coordinating Committee (NECC), chaired by Prof Jakes (GJ) Gerwel, then Vice-Chancellor of the University of the Western Cape, was undertaken between December 1990 and August 1992 with the outcomes captured in a series of 12 research texts and a framework document, published by Oxford University Press in 1992.<sup>7</sup>

The NCHE, established by presidential proclamation in December 1994, was one of the first policy actions of the post-apartheid Department of Education (DoE) and paved the way for the 1997 *White Paper* and HE Act. As succinctly summed up at the time, the Commission was charged “with advising

the government of national unity on issues concerning the restructuring of higher education by undertaking a situation analysis, formulating a vision for higher education and putting forward policy proposals designed to ensure the development of a well-planned, integrated, high quality system of higher education.”<sup>8</sup>

The University of Pretoria’s development during the review years mirrored in several ways change in higher education nationally and globally, and societal change more broadly. At a national level there were important policies, events and commissions that informed the actions of individual institutions and the university sector as a whole. To single out a few that were of direct relevance, especially to the strategies universities pursued:

- The Department of Science and Technology (DST) ten-year plan, Innovation towards a knowledge-based economy 2008–2018 (2008)
- South Africa’s National Development Plan — Vision for 2030 (2011)
- Two higher education summits, hosted by the Minister of Higher Education and Training, in 2010 and 2015, respectively
- The Heher Commission into the feasibility of making higher education and training fee-free in South Africa, November 2017.

At regional and global levels, the African Union (AU) *Agenda 2063*, and the United Nations (UN) *Sustainable Development Goals* further framed the strategic direction of the University.

UP was deliberately positioned within these broad local, regional and international contexts to be a leading research-intensive university in Africa; a university that seeks to make a difference. Key pivots were quality research and strengthening UP’s international footprint; enrolment planning and steering the ‘shape and size’ of the institution; the student experience and enhancing access with success; infrastructural development and building an environment in which students and staff could thrive; and engagement with local communities and in societal challenges.

## 2 | Higher education in South Africa

Dr Diane Parker, DDG: University Education, DHET<sup>9</sup>

In 2009, a new national Ministry and Department of Higher Education and Training (DHET) were established in order to integrate post-school education and training into a single coordinated system to enable “a skilled and capable workforce to support an inclusive growth path”<sup>10</sup>. This brought together, under one umbrella, universities, further education and training colleges, and adult education and skills development. The previous national Department of Education (DoE) was restructured as the Department of Basic Education (DBE), with an exclusive focus on schooling.

For universities, the decade that preceded this structural change was marked by two system-level imperatives aligned with the *White Paper 3* (1997)<sup>11</sup> and the *National Plan for Higher Education* (2001):<sup>12</sup> increasing access and participation — or the massification of the system; and restructuring a diversified public higher education landscape, both key elements for the transformation of the system. The decade that followed was marked by moderate growth aligned to the mandate of institutions, supporting students enrolled to succeed, and collaboration and partnerships to strengthen the system.

The period 2009 to 2018 will also be remembered as a period when the higher education and training system was rocked by violent disruption and volatility within an increasingly financially and politically hostile environment, as a result of the Fallist movement spearheaded by students. As the decade progressed, the imperative was not simply to speed up the rate of transformation, but importantly, to ‘decolonise’ higher education.

### Policy, planning and realignment

In April 2010, the first of two higher education stakeholder summits was hosted by the new Minister of Higher Education and Training, Dr Blade Nzimande. Following the summit, a key priority was to develop a *Green Paper for Post-School Education and Training* (January 2012). The paper conceptualised post-school education and training (PSET), not as a post-secondary system, but as a system serving the youth and adults, no

matter what their level of education had been in the past. The *Green Paper* was followed by a new *White Paper*<sup>13</sup> released in early 2014, and a subsequent process towards developing a new National Plan for PSET (NPPSET).<sup>14</sup>

These policy and planning documents and processes took into account the *National Development Plan — Vision for 2030*,<sup>15</sup> and contextual issues which resulted in shifts in the role of universities as public higher education institutions. For example, the importance of building capacity in the technical and vocational education and training (TVET) sector was again foregrounded, and the need to grow this sector at a greater rate than the university sector to ‘invert the pyramid’. The concept of Community Education and Training (CET) was introduced, targeting adults who had not been to school, or who had dropped out of school and could not access post-secondary education.

Over the decade, a number of Ministerial Committees and task teams were appointed to advise on a range of issues and to review progress and develop policy:

- Ministerial Committees included the Review of the National Student Financial Aid Scheme (NSFAS, 2010); Student Housing (2012); University Funding (2013); Fee Free Higher Education (2013); African Languages as Mediums of Instruction (2015); and the Black Professoriate (2018).
- DHET task teams included: the review of the HE Act

<sup>4</sup> Department of Education. 1997. *White Paper 3. A programme for the transformation of higher education*. Pretoria.

<sup>5</sup> Department of Education. Higher Education Act 1997. Act No.101 of 1997.

<sup>6</sup> DHET. 2013. *White Paper for post-school education and training: Building an expanded, effective and integrated post-school education system*.

<sup>7</sup> It is relevant to include the NECC here as in the years 2015 to 2017, at the height of the #FeesMustFall student protests, there was an attempt to replicate the NECC model in order constructively to engage with students and harness the destructive consequences of the protests.

<sup>8</sup> N Cloete and J Muller. 1998. ‘South African higher education reform: what comes after post-colonialism?’ *European Review* 6(04), 525–542, October 1998.

<sup>9</sup> Dr Parker was the Deputy Director-General: University Education of the DHET, first in an acting capacity, from July 2010 to January 2021. In 2021 she joined the University of Pretoria.

<sup>10</sup> DHET. 2010. Revised Strategic Plan 2010/11 to 2014/15, p.8.

<sup>11</sup> Department of Education. 1997. *White Paper 3. A Programme for Higher Education Transformation*, Government Gazette No. 18207 (3), 15 August 1997.

<sup>12</sup> Department of Education. 2001. *National Plan for Higher Education*, February 2001. Government Gazette No.22138 (230), 9 March 2001.

<sup>13</sup> DHET. 2013. *White Paper for Post School Education and Training: Building an Expanded, Effective and Integrated Post-School System*.

<sup>14</sup> The first consultative version of the NPPSET was completed in early 2017. However its development and subsequent release for consultation was interrupted by a host of unanticipated events including the #FeesMustFall campaign, the Fees Commission and multiple changes in the responsible Minister (in October 2017, April 2018 and May 2019). After numerous iterations, it was due to be published towards the end of 2021. However, by 2023 it had not been formally released. This illustrates the disruption in the work of the DHET over the last five years of the decade.

<sup>15</sup> National Planning Commission. 2013. *National Development Plan — Vision for 2030*. The Presidency.

(2016); the development of good governance guidelines (2017); the review of the research outputs policy (2015); the development of the creative outputs policy (2017); internationalisation of higher education (draft gazetted in 2018, final in 2020); and the review of languages in education policy (draft gazetted in 2017, final in 2020).

These committees and task teams made a significant contribution to the development of new policies and practices for the higher education sector.

*White Paper 3* envisioned a single coordinated public higher education system structurally transformed through mergers and incorporations of 37 institutions in apartheid South Africa (universities and technikons) and numerous colleges of education. By the end of 2010, the system comprised 23 universities — 11 traditional universities, six comprehensive universities and six universities of technology, and enrolment had grown by 82% from 495 356 in 1994 to 892 936 by 2010. While some institutions, like the University of Pretoria, retained their original names, the majority took on new names and identities.

In 2010, a strategic decision was taken to establish new universities. The Ministerial Task Team, co-chaired by Profs Cheryl de la Rey and Thandwa (T) Mthembu (Vice-Chancellor of Central University of Technology), made recommendations in August 2011. Following an intense process of planning and discussion, the University of Mpumalanga and the Sol Plaatje University were established in August 2013. In 2015, a third new university, the Sefako Makgatho Health Sciences

University, was established after a process of unbundling the former Medical University of South Africa campus from the University of Limpopo, following a failed merger.

### Steering mechanisms

As noted in the introduction to this chapter, the 1997 *White Paper 3* continued to frame the transformation of the higher education system in the decades that followed. In this context, three mechanisms were identified as critical in steering the development of the higher education system: funding, planning and quality assurance.

### Funding

The funding framework<sup>16</sup>, introduced in 2004, is a transparent instrument determining the distribution of funds to institutions through block and earmarked grants. The block grant is determined by performance in relation to enrolment targets, and graduate and research outputs. Earmarked grants are grants for specific purposes<sup>17</sup> linked to capacity development and transformation in the system.

In 2013, the framework was reviewed by a Ministerial Task Team, amidst concerns that it did not support a differentiated system and was driving the system towards homogeneity. The review showed that this was not the case, and recommended that it should be retained with some changes. A revised framework was drafted but its approval was interrupted by major student upheavals in the system in 2015, sparked by double-digit fee increases at high-fee institutions, and the

subsequent Presidential Fees Commission and processes around fee compacts.

The Department made the decision, following the Ministerial Review of University Funding,<sup>18</sup> to phase out the teaching development and research development grants (T/RDGs), which had proved to be problematic and were not being used to support success as intended, in favour of supporting a University Capacity Development Programme (UCDP). From 2015, unspent T/RDGs funds in the system were pooled to support the new Staffing South Africa's Universities' Framework (SSAUF) and collaborative projects or programmes designed to support student success and capacity development in the system. At the same time, a new Historically Disadvantaged Institutions' grant was introduced to assist the holistic development of these institutions.

The new Generation of Academics Programme (nGAP), part of the SSAUF, was launched in October 2015. This was the precursor to a number of different programmes to support the transformative development of staff, students and institutions. A key aspect underpinning the programme was collaboration and partnerships (international and local) for the development of all aspects of the system, including the University Staff Doctoral Programme (USDP) and the establishment of the United States–South Africa (US–SA) network, the Entrepreneurship Development in Higher Education (EDHE) Programme, and the Higher Education Leadership and Management Programme (HELM). The first cycle of the fully developed UCDP,<sup>19</sup> providing funding to universities on the basis of institutional plans, and expanding the implementation of the SSAUF and other collaborative programmes, was implemented in 2018.

### Planning

Funding is intrinsically linked to planning and undertaken at national and institutional levels. This included enrolment and infrastructure planning, and the development of system capacity and quality.

Over the decade, enrolment planning negotiations leading to institutional targets and the national enrolment plan, were driven by two key imperatives: the targets for higher

education set in the National Development Plan (NDP); and ensuring that the targets set by institutions could be supported by their human and infrastructural resources, which had not kept up with growth in the system in the previous decade.

While growth was seen as important to enable access, student success was equally important. Based on agreements with universities on individual enrolment plans for the period 2011 to 2013, the Department projected an average annual growth rate of 1,14% and 3,76% for undergraduate and postgraduate enrolments, respectively. However, the actual audited growth over this period was higher than projected at an average of 3,38% for undergraduate and 5,08% for postgraduate per annum. The over-enrolment led to underfunding of the system and a strain on NSFAS, contributing to institutions increasing fees at rates higher than inflation, often in an attempt to 'balance their budgets' in the face of declining state funding.<sup>20</sup>

In preparing for the second enrolment planning period (2014–2016) the DHET made a strategic decision to change its processes and introduce a longer planning horizon of six years (2014–2019), with a mid-year review after the first three years. This was accompanied by the phasing-in of financial penalties, first for under-enrolling on overall targets, and later for over-enrolling on first-time entry targets, in an attempt to persuade institutions to adhere to their contracts with the Minister. While some institutions argued that they were responding to the NDP targets and opening access by over-enrolling, this position was not supported by the DHET as the sustainability of the system as a whole had to be protected. The focus needed to move from access (increasing enrolments) to success (improved graduation and throughput).

Over the period 2014 to 2019, the total headcount enrolment in the university sector reached 1 074 912 in 2019 (an average annual growth of 1,6% per annum), student throughput rates improved steadily, doctoral outputs increased significantly (from 2 258 in 2014 to 3 445 in 2019), and the percentage of university staff with doctoral qualifications improved (from 43% in 2014 to 48% in 2019).

The following were published by the DHET and/or gazetted in the period 2009 to 2018:

2010	Report of the Ministerial Committee on the Review of the National Financial Aid Scheme
2011	Report on the Ministerial Committee for the Review of the Provision of Student Housing at South African Universities; extract published in the Government Gazette, No 35540, Notice 201, 25 July 2012
2013	Report of the Ministerial Committee for the Review of the Funding of Universities; foreword published in the Government Gazette, No 37384, Notice 143, 28 February 2014
2013	Report of the Ministerial Working Group on Free University Education for the Poor in South Africa
2015	Report on the use of African Languages as Mediums of Instruction in Higher Education
2015	Research Outputs Policy, Government Gazette No 38552, Notice 188, 11 March 2015
2015	The Higher Education Amendment Bill, Government Gazette No 39384 of 9 November 2015, promulgated as the Higher Education Amendment Act 9 of 2016
2017	A code of good governance practice and governance indicators for South African universities
2017	Policy on the evaluation of creative outputs and innovations produced by public higher education institutions, Government Gazette No 40819, Notice 395, 28 April 2017

<sup>16</sup> Department of Education. 2004. A new funding framework: How government grants are allocated to public higher education institutions.

<sup>17</sup> These evolved over time, linked to needs in the system. In the period under review there were important innovations in the system linked to the infrastructure and efficiency grant, the introduction of the university capacity development grant and the historically disadvantaged institutions' (HDIs) development grant.

<sup>18</sup> DHET. 2013. Report of the Ministerial Committee on the Review of the Funding of Universities.

<sup>19</sup> DHET. 2017. Ministerial Statement on the Implementation of the University Capacity Development Programme through Effective Management and Utilisation of the University Capacity Development Grant 2018–2020, released March 2017.

<sup>20</sup> By 2013, the per capita funding per student enrolled in the system had increased in real terms by 3,01% since 2004; however, over that period enrolments had increased by 31,89% and infrastructure and support needs were growing at a much higher rate.

## Quality assurance

The role of quality assurance in steering the system had become increasingly important in the years following the publication of the initial Higher Education Qualifications Framework (HEQF) in 2008, and the revised Higher Education Qualifications Sub-Framework (HEQSF), published in 2014. The Council on Higher Education (CHE), whose responsibility it is to ensure the quality of the system, experienced many challenges over this period. Universities were required to re-curriculate their programmes in line with the HEQSF, and to ensure that aligned programmes were accredited before commencement of the 2019 academic year.<sup>21</sup> This process was extremely bureaucratic, focusing on ensuring that programmes were accredited and registered by the South African Qualifications Authority (SAQA) on the National Qualifications Framework (NQF), and required enormous institutional energy.

An unintended consequence was that many institutions focused on compliance and may have missed the opportunity to interrogate their programme and qualification mix (PQM) and curricula, especially in the wake of the #FeesMustFall movement. With the benefit of hindsight, it also became clear that institutions did not fully understand the process and the implementation of a complex system invariably led to a range of issues and misalignment of the regulators' databases.

In addition to student access and success, *White Paper 3* had identified research as an important area for the development of the sector and, in 2004, the Department implemented a policy for evaluating and subsidising research to incentivise the system.<sup>22</sup> By 2010, the research outputs of the system had increased substantially and continued to do so over the next decade. The weighted research output per capita was 1,12, up from 0,95 in 2005. By 2019 it was 2,01.<sup>23</sup> However, there were some questions regarding the quality of research outputs and, at the same time, there was strong motivation for the inclusion of creative outputs and innovations in subsidised research outputs. The revised policy on research outputs was published in 2015, and a new policy on creative outputs and innovations in 2017.

Over this period, the issues of research ethics and predatory publishing were identified as major concerns. Further, the importance of collaborative research and international

research partnerships was emphasised. A significant intervention was the DHET's partnership with the Department of Science and Technology (DST) and the National Research Foundation (NRF) to support academic staff to gain doctoral qualifications and thereby improve research productivity and capacity, and system-level research and development (R&D).<sup>24</sup>

## An era of discontent

The pressure on the university system to grow, the increased participation of students from poor and working-class families, the lack of additional funding to support them, and institutions increasing fees at unsustainable rates — together with the growing discontent of students at the lack of fundamental change — created the perfect conditions for increasing and often violent disruption across the public higher education sector.

While access to higher education had opened up to economically disadvantaged students through the expansion of NSFAS, year-on-year, funding became severely limited and many students who were accepted were not able to fully fund themselves. This led to increasing debt and hardship for students, including hunger and uncondusive living arrangements. At the same time, the political message and norm had become that academically deserving students should not be denied access to higher education due to a lack of financial means. The Minister of Higher Education and Training urged institutions to allow all such students to register, and indicated that funding would need to be found to support them. This led to a situation of increasing enrolment of students who qualified for NSFAS funding but either had no funding or capped funding. As a result, there was an increasing burden of debt, on individual students and institutions that carried the debt burden in unpaid fees.

Over the period 2010 to 2015, the total student debt in the system more than doubled from R3,2 billion to R6,5 billion, and purportedly a significant amount of this debt was owed by about 75 000 underfunded NSFAS qualifying students registered in institutions in 2015.<sup>25</sup> Simultaneously, high fees were squeezing the so-called 'missing middle' students who did not qualify for NSFAS, based on household income, out of universities.

<sup>21</sup> Government Gazette No.40123, 6 July 2016. Notice of last enrolment date for first-time entering students into non-aligned HEQSF programmes.

<sup>22</sup> Department of Education. 2003. Policy for the measurement of research outputs of public higher education institutions.

<sup>23</sup> DHET. 2020. Report on the evaluation of the 2019 universities' research output.

<sup>24</sup> J Mouton et al. 2019. The Quality of South Africa's Research Publications. Pretoria. See also J Mouton et al., 2018. The Silent Majority. A study commissioned by the Department of Science and Technology on building a cadre of emerging scholars for higher education in South Africa.

<sup>25</sup> The Presidency. 2015. Report of the Presidential Task Team on Short-Term Student Funding Challenges at Universities, November 2015.



Credit: Perdeby

A second stakeholder summit on higher education transformation was held in October 2015, at the height of this season of discontent.<sup>26</sup> The purpose of the Summit was to engage in critical dialogue on the higher education system, to take stock of the changes since the first Summit in 2010, and to re-imagine higher education transformation. The Summit provided a platform for student leaders to come together from across the country. The first day coincided with the explosive protest at the University of the Witwatersrand after an announcement of a double-digit fee increase for the following year, launching the #FeesMustFall campaign nationwide.

That the protests erupted in a historically advantaged institution, and then spread across the system in such a violent manner, was unprecedented. The sector was accustomed to annual protests at the beginning of the year in the more disadvantaged institutions, but now it was driven by students at advantaged institutions.

### Consequences of student protests

#FeesMustFall student demands led to an agreement, brokered by the then President of South Africa, Jacob Zuma, towards the end of October 2015, on a 0% fee increase for 2016, that students would return to their campuses and write exams without further disruption, and that other matters raised, such as the insourcing of all workers, student debt and NSFAS student funding, would be dealt with through engagements at a later stage.

While the agreement was intended to quieten the protests and ensure that exams would take place, it was followed by further violent protests and destruction of property, with the demand for free, quality, decolonised higher education and the immediate insourcing of workers reverberating across the country.

As Lange (2020)<sup>27</sup> subsequently wrote, the goal of access and redress — expressed in the 1997 *White Paper 3* and the *National Plan for Higher Education* (NPHE) of 2001 — changed into the goal of free higher education for all students by 2015, and the goal of reconstruction and development through higher education changed into the goal of ‘decolonising’ universities and the country.

“The very fact that the #FeesMustFall generation has dismissed ‘transformation’ as a failed political project invites reflection on what universities, and government, mean when they talk about transformation today.”

Institutions across the country reacted to these challenges. Some immediately insourced workers in an attempt to quell the disruption. Most institutions had to complete the academic year through the introduction of online teaching and other methods to complete the syllabus and examinations under difficult conditions. Institutions also sought to protect staff and students, by sourcing additional security at considerable cost.

The securitisation of campuses and the escalation of violent confrontations was seen across the sector for some time, extending into 2016 and beyond. This acted as a catalyst for many institutions to digitalise their enterprise and develop mitigating strategies to deal with future disruptions. Institutions that invested in IT infrastructure during this period were well positioned to pivot to online learning when confronted by more revolt challenges. UP was one of these.

Following the enveloping student protests, there was a realisation that the system needed to galvanise itself and find ways of cooperating and collaborating for the greater good of all. Universities South Africa (USAf) and the DHET worked closely together in the following years to support collaboration and partnerships to strengthen the sector. Many of these were funded through the UCDP.

### The Fees Commission and interim measures

Following the 2015 disruptions, in January 2016, the President announced, the appointment of a Commission of Inquiry into Higher Education and Training. Chaired by Judge Heher, the Commission came to be known as the Fees Commission, and completed its report in August 2017.<sup>28</sup>

As an interim measure, and while the Commission was doing its work, the DHET significantly increased funding into the baseline of universities. This was to make up the shortfall due to the 0% fee increase agreement for 2016, and subsequent agreements for 2017, and provided additional funds to support NSFAS qualifying students.

The Commission recommended that baseline funding to universities be increased to 1% of GDP, that student tuition fees should be regulated, and that a universal income-contingent loan system be implemented to ensure access to higher education for all.

Further recommendations related to the block funding to post-school education and training (PSET) institutions that needed to increase in line with the increased costs of quality education and infrastructure; that a cost-sharing model be implemented for university education; that the community education and training (CET) sector be funded in the same way as basic education; that public technical and vocational education training (TVET) education be fee-free (100% funding), and that stipends be made available through TVET colleges, for needy students to cover the full cost of study.

Flouting the Commission's recommendations, President Jacob Zuma announced, in December 2017, that the South African government would phase in fully subsidised free higher education<sup>29</sup> for students in universities from families earning up to R350 000 per annum, starting with the first-year cohort in 2018. At the same time, recognising that subsidy funding had been under pressure, Zuma announced that additional funding would be phased-in into the baseline of public universities to reach 1% of GDP within five years. This would be done while the university sector worked out a fee regulation policy to ensure that fee increases were reasonable and fees across the system were affordable.

The years following 2015 were characterised by annual fee compacts linked to CPI inflation for the system, while significant additional funding was injected into the block grant and for NSFAS qualifying students, bringing the proportion of undergraduate students supported from approximately 21% in 2015 to 56% by 2019. Notwithstanding the additional injection of funding into the baseline of institutions, the sudden implementation of the scheme created many challenges, including a collapse of the NSFAS systems.

By the end of the decade, mainly due to the government decision to include accommodation, food and transport as part of what constituted ‘free higher education’, the scheme would prove to be unsustainable.

### Resilience and growth

The university system, while it struggled through some of the most disruptive and difficult times in its history, showed resilience as it continued to grow and improve its relevance and capacity.

The shock of students’ disillusionment forced universities to reconsider their positions in society, to focus on what matters and how students could better be supported to

succeed. Further, the importance of open dialogue with students, developing student leadership capability to ensure that university spaces remain critical and open, finding ways to balance the security of staff and students and at the same time supporting constructive learning and teaching, research and living, were all challenges that had to be faced. Universities had to become more responsive to their publics, recognising their local embeddedness and the importance of engagement.

The University of Pretoria navigated these spaces, building its reputation while being responsive to the changing context, and strengthening its position within the South African higher education landscape. It played a unique role under the leadership of Prof De la Rey. There were many instances of collaboration and system-level development processes; below a few illustrations:

In 2014, Prof De la Rey agreed to a partnership with the DHET in the implementation of the Sector Planning, Monitoring, Evaluation and Support Programme (SPMESP), a strategic programme which supported institutions’ capacity to monitor the implementation of plans across the higher education sector, and to undertake specific research to inform developments in the system. In this sense, UP played a critical role in supporting, among others, the development of the infrastructure programme, the state’s international scholarships programme, the university capacity development programme, the research outputs and the creative outputs evaluation processes.

Prof De la Rey embraced the nGAP programme, pledging to support double the posts that the Department funded at the University. She supported the implementation of a number of collaborative programmes, including the USDP and the United States–South Africa network, agreeing that a coordinating structure could be located at UP. This was an important collaborative project between the 26 South African

<sup>26</sup> Department of Higher Education and Training. 2016. Report on the Second National Higher Education Transformation Summit: International Convention Centre, Durban, KwaZulu-Natal, 15–17 October 2015. Published January 2016.

<sup>27</sup> L Lange. 2020. Transformation Revisited: Twenty Years of Higher Education Policy in South Africa, Chapter 3, in I Rensburg, S Motala and M Cross (Eds), *Transforming Universities in South Africa: Pathways to Higher Education Reform*. African Higher Education: Developments and Perspectives, Vol 6, p.43. Brill.

<sup>28</sup> <https://www.justice.gov.za/commissions/feeshet/index.html>

<sup>29</sup> This was implemented as the NSFAS managed the DHET Bursary Fund for first-time entry poor and working-class students in the 2018 academic year.

universities and 12 US-based universities supporting over 150 staff members to undertake their doctoral studies.

UP also contributed significantly to increasing doctoral graduates across the system and increasing the proportion

of staff with doctoral qualifications. By 2019, UP produced a total of 399 doctoral graduates (11,5% of doctoral graduates nationally), with just under 70% of its instructional and research staff holding doctoral qualifications, the highest proportion of any public university in South Africa.



Futhi Mtoba, Chairperson of the University of Pretoria Council, Prof Cheryl de la Rey, Vice-Chancellor and Principal, Prof Mary Metcalfe, Director-General in the Department of Higher Education and Training, Prof Lumkile Nkuhlu, Chancellor of the University of Pretoria

### 3 | The cornerstones of UP 2025

As the new Vice-Chancellor and Principal of the University of Pretoria, in her inaugural address on 16 April 2010,<sup>30</sup> Prof De la Rey presented an analysis of changing contexts and what national and global trends meant for the role of universities, and more specifically, for UP's strategy into the future. Resilience and adaptability were features that enabled universities to survive through historical changes. What distinguished those who not only survive but thrive and succeed was the ability to focus firmly on academic excellence while being adaptable and responsive to changing social and economic circumstances. Knowledge and innovation had become drivers of economic growth and national competitiveness, while technological advances had changed the nature of academic work — both teaching and learning, and research. South Africa was a country of sharp and stark contrasts and reconstructing South African society into a democracy necessitated a further level of change that compelled universities to respond.

Understanding the role of UP as a public university in a young democracy was important in the development of the University's long-term strategy. The reasons were clear: firstly, in addition to developing human capital, a strong, resilient and peaceful democracy depended on a shared sense of "civic responsibility, social interconnectedness and social justice". Secondly, in executing this role as a public university, it was important to recognise that UP operated in an interdependent, highly competitive global world.

Prof De la Rey acknowledged that although there was no blueprint for the strategies that needed to be pursued, the core ingredients were clear from the experiences of other countries, particularly middle-income and developing countries: the quality of the total student experience — including social, cultural and sporting activities; the 'what and how' of teaching and learning and the curriculum, and whether the institution was sufficiently geared to a world of rapid change; diversity and transformation, and the need explicitly to recognise the University as a social space where individuals from diverse backgrounds come together to work and to learn. At the same time as it improved the quality of the student experience, the University needed to intensify its research productivity and impact; develop a high quality curriculum at undergraduate levels, which inspires a passion for inquiry; and grow postgraduate enrolment, particularly at the doctoral level. These required clearly articulated curriculum pathways from undergraduate to postgraduate study.

Research and scholarship had become "a collaborative, communitarian pursuit involving teams of scholars and students in networks that cross institutional and national boundaries". This meant that UP needed to create an enabling environment to leverage discipline-specific expertise and to bring together scholars across boundaries to tackle the most pressing problems facing the country and the African region. These included climate change, food security, conflict mediation, poverty alleviation and other such issues that had the best chance of being addressed through multidisciplinary teams that, in addition to scientific expertise, "exercise ethical judgement, empathy and a commitment to social justice".

Community engagement was tied to promoting good citizenship and sustainable development. Sustainability and sustainable development were terms often used in contemporary society. For Prof De la Rey, this required a holistic perspective in order to see the connections and interconnections between systems and institutions. One of the challenges was to grow the University's resource base and to ensure that available resources were efficiently and effectively used.

Prof De la Rey concluded her address with a comment often made — "the future is not predictable and there are no certainties". She nevertheless expressed certainty that the commitment to "quality, relevance, a culture of inquiry and sustainability"<sup>31</sup> will be the principles that will drive the strategy for building the second 100 years of the University of Pretoria.

<sup>30</sup> University of Pretoria. Installation of Vice-Chancellor and Principal, Prof Cheryl de la Rey. 16 April 2010. What follows in this section is a synthesis of the main issues covered in her address.

<sup>31</sup> These were refined into what came to be called 'navigational markers' in subsequent documents and in UP 2025 — quality, relevance, diversity and sustainability.

Her sweeping analysis of context, in fact, set up a framework — or indeed a blueprint — for the University's strategy over the medium to longer term.

### The transition to a long-term strategy

In June 2010, an institutional planning document<sup>32</sup> set the parameters for the UP 2011 Plan, the final year in the implementation of the University's previous strategic plan, 2007–2011.<sup>33</sup> Marked by the transition between two sets of strategic plans, the planning framework, it was said, “codified the nascent consensus” that had arisen in the many *berade*<sup>34</sup> and workshops held under the guidance of the new Vice-Chancellor since her appointment, and set the direction UP would need to take over the longer term.

This document, and other planning documents that followed, were intended to be enabling, not restrictive — to encourage members of the University community to develop “ambitious dreams”, to envisage a university with a prominent international profile (a critical issue foregrounded in 2010),<sup>35</sup> and to conceive workable plans for ensuring this. By the time the development of the new long-term strategy was launched on 20 September 2010, the UP community was asked to “imagine UP in 2025” — again a familiar refrain compelling the University community to action. The appeal was for contributions to a strategic framework and plan that would strengthen and embed a vision and identity for the University into the future.

There was a further process initiated in 2010 that directly influenced the development of the University of Pretoria's long-term strategy: four task teams were appointed to undertake detailed environmental scans and a SWOT analysis of the University's strengths, weaknesses, and externally, opportunities and threats. The task team reports were presented to the UP Executive and Senior Management in November 2010, and agreement was reached to use the outcomes as the conceptual cornerstones in the development of the University's Strategic Plan 2025.

It was clear at the time, that the status quo position in terms of existing practices was not a sufficiently strong basis from which to pursue a future-oriented vision for the University. That said, it was also recognised that fundamental long-term strategies related to core functions and public accountability were unlikely to change over the next 15 years. The focus therefore needed to be on harnessing existing strengths that would embed the University's distinct role and identity, nationally and globally, in rapidly changing contexts.<sup>36</sup>

The spheres of influence of UP — current and future — were many and meant that strategic choices would have to be made to ensure the greatest impact and visibility for the University, and therefore that trade-offs would be necessary.

Major external factors were associated with globalisation, the impact of technology and environmental changes that would affect both research and teaching and learning. In essence, therefore, “in a shrinking world, the research we do and the way we teach will increasingly be placed in the international spotlight”; the requirement to grow our international strength was an imperative.<sup>37</sup>

What follows below is a synthesis of the main themes in this collective body of work:

#### Building on strengths

A central theme, expressed in different ways, was the time and place locality of the University of Pretoria — in the capital city, in South Africa and on the African continent, and simultaneously, in a 21st century world where knowledge production was the global currency of universities.<sup>38</sup>

The University of Pretoria had distinct strengths which related to its sheer size and diversity with respect to the profile of students, the wide range of core and professional programmes it offered, and its spread of campuses. It had distinct areas of research excellence of world reknown.

Relevance, diversity, sustainability and quality were issues that were strongly profiled, and are elaborated on in Chapter 3. It was a well-functioning and financially stable institution.

However, in order to retain its sustainability as a well-functioning and stable university, several conditions needed to be met, among which were planned enrolment growth that would entrench the identity of UP as a research-intensive university. Students would need to fit this profile and have the ability and interest to pursue university studies; teaching and learning would need to follow a questioning or an inquiry-led approach and strengthen the pipeline to postgraduate studies; research would need to be relevant to local contexts and be recognised in the global scientific community.

#### 21st century knowledge-driven world

Much has been written about the consequences of a 21st century knowledge economy and world, made possible by the ICT revolution, and its impact on the role of universities.

An influential social theorist, Manuel Castells,<sup>39</sup> informed debates in South African higher education circles and in the realm of politics. Castells argued that the rise of information technology and globalisation have led to a new kind of network society that operates on processes of variable inclusion and exclusion. His detailed and provocative analyses of the consequences of what he termed the “global informational capitalism”, supported by an independently occurring technological revolution centred on information and communication technologies, caught the imagination of many scholars in South Africa.

The world was increasingly characterised by those communities and places that were included in rapid developments in knowledge production and technological innovation, and those who were on the periphery. Castells referred to the latter as the “Fourth World”, which can be large tracts of land in the global South without functional states, inhabited by poverty-stricken communities, or entire ghettoised neighbourhoods in Northern cities. In the early 2000s he was twice invited to meet with the then President Thabo Mbeki who appointed a ministerial task team to explore the possibilities (and threats) for South Africa's development.

UP had already harnessed the possibilities afforded to it by expanded networks and partnerships in several ways, especially in the realm of research and, at the time, perhaps to a lesser extent in teaching and learning. Central to these were the ICT platforms which made new linkages and forms of knowledge production and information dissemination,

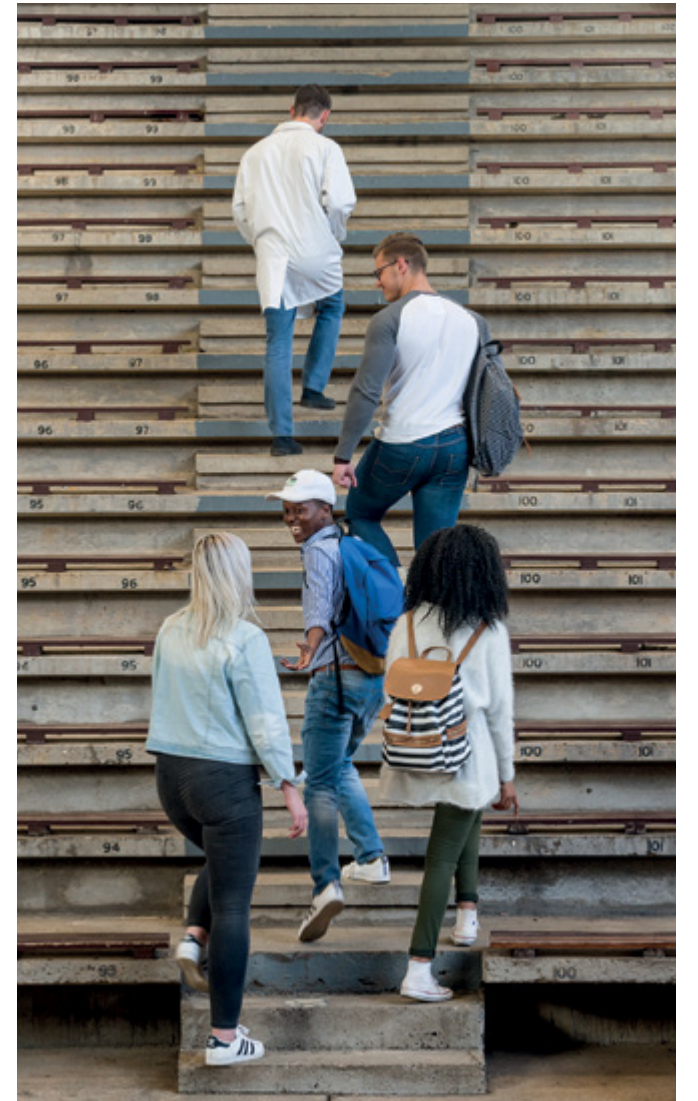

in addition to systems for the effective management and operations of the University possible.

#### Knowledge divides and ‘wicked problems’

A World Social Science report published in 2013<sup>40</sup> provided extensive analyses across regions on the divides in knowledge production, dissemination and use. The conclusions were clear: knowledge divides occur as a result of inequalities and asymmetries in the accumulation, transmission and use of knowledge in different societies and regions. As described in the report, given huge disparities in research capacities across countries and regions, knowledge divides were manifest at

<sup>32</sup> University of Pretoria. 2010. Institutional Planning for 2011: A strategic overview for compiling faculty and support service plans. June 2010.

<sup>33</sup> Strategic Plan of the University of Pretoria, 2007–2011. *The Innovation Generation: Creating the Future*.

<sup>34</sup> *Berade* are deliberations, an Afrikaans word often used to describe workshops or think tanks.

<sup>35</sup> University of Pretoria, August 2010. Global University: Report to the Executive by the Task Team to Develop an Internationalisation Strategy.

<sup>36</sup> Planning Steering Committee, January 2011. Consolidated Report: Developing UP's Strategic Plan 2025.

<sup>37</sup> University of Pretoria. 2010. Group 4 Report, November 2010.

<sup>38</sup> See also N Badsha. 2016. Foreword. *Reflections of South African University Leaders 1981 to 2014*. African Minds: Cape Town.

<sup>39</sup> N Cloete et al. (eds). 2002 (and 2006). *Transformation in Higher Education: global pressures and local realities* (Springer); J Muller et al. (eds). 2017. *Castells in Africa: universities and development* (African Minds Publishing); M Castells (ed). 2014. *Reconceptualising Development in the Global Information Age* (Oxford Academic, online accessed 15 March 2023).

<sup>40</sup> World Social Science Report. 2013. *Knowledge Divides. Summary*, June 2013. A joint report of UNESCO and the International Social Science Council (ISSC). The report was launched in South Africa at UP in 2014.

different levels. In addition to geographic and capacity divides at a systemic level, there were also divides linked to the fragmentation of knowledge, the divide between disciplines, academics and society, and academics and policy makers.

Further, it was widely recognised that the ‘wicked problems’ of the 21st century demanded multidimensional approaches to research, innovation and technology transfer. The corollary was that curricula must be locally relevant and, at the same time, aligned to global issues and ideas (i.e., to the best of knowledge available on particular issues or problems — be this in the abstract or directly affecting the daily lives of people).

As captured in the World Social Science report, “The scale, rate, magnitude and significance of changes to the global environment have made it clear that ‘research as usual’ will not suffice to help individuals and groups understand and respond to the multiple, interacting changes that are now occurring.”<sup>41</sup>

It was therefore not a matter of trade-offs between local contextual imperatives and competing or participating in global research efforts, but simultaneously to locate the University’s academic project in *time* and *place*. Also, it was not a matter of privileging some areas of study (e.g., science, maths, engineering and technology), at the expense of others (the social sciences and humanities).

It was obvious, however, that given resource constraints, priorities would need to be set to achieve critical scale, and to avoid resources being stretched too thinly over too many activities.<sup>42</sup>

### Enrolment planning and diversity

The massification of higher education meant that universities all over the world have increasingly become more accessible to a diversity of students. While this has, in general, meant a move from elite to mass to full participation, the complexities linked to ‘access with success’, especially in developing regions, still had to be fully addressed.

In South Africa, the focus shifted to planned enrolment growth as opposed to the massification anticipated or hoped for in the *White Paper 3* of 1997, and the earlier National Commission on Higher Education (1996).

Enormous challenges remained in the provision of quality education from pre-school to Grade 12 and beyond, and unequal access to post-school opportunities constituted a major barrier to addressing the deep social and demographic divides in South Africa. As a consequence, fair and equitable access to university studies remained high on the transformation agenda of the public higher education sector, as did the success of students enrolled.

Table 1.1. Public higher education headcount enrolments by race, 2009 to 2018<sup>43</sup>

	2009	2015	2018
<b>African</b>	547 686 (65,5%)	696 320 (71,5%)	820 619 (76,4%)
<b>Coloured</b>	55 101 (6,6%)	62 186 (6,4%)	65 911 (6,1%)
<b>Indian</b>	53 629 (6,4%)	53 378 (5,5%)	47 865 (4,5%)
<b>White</b>	179 232 (21,4%)	161 739 (16,6%)	140 304 (13,1%)
<b>Total</b>	835 648	973 623	1 074 699

Source: VitalStats, CHE, 2014 and 2016

Over the same period, the headcount enrolments at the University of Pretoria were as follows:

Table 1.2. University of Pretoria headcount enrolments by race, 2009 to 2018

	2009	2015	2018
<b>African</b>	29 316 (52,6%)	28 050 (50,1%)	25 216 (50,0%)
<b>Coloured</b>	965 (1,7%)	1 264 (2,3%)	1 420 (2,8%)
<b>Indian</b>	1 835 (3,3%)	2 735 (4,9%)	2 968 (5,9%)
<b>White</b>	23 618 (42,4%)	23 858 (42,6%)	20 810 (41,3%)
<b>Total</b>	55 734	55 984	50 431

Source: HEMIS data, Department of Institutional Planning

In the development of UP 2025, it was clear that the University would need to keep its focus on becoming a thriving major research university. Whereas access to professional degrees was relatively well-structured by often highly selective admission criteria,

“...it is the BA, BSc and BCom degrees that are the pipeline to most of our postgraduate degree programmes, that are less protected against uncoordinated growth. Whereas the diversity of students that we can attract to these degrees is measurement of our strength, we will not be able to maintain excellence in both undergraduate teaching and research if we attempt to be a university that tries to sit on all possible chairs simultaneously. This challenge is part of diversity management.”<sup>44</sup>

The lower headcount enrolments in 2018 were in large part due to the decrease in distance enrolment in the Faculty of Education (see also section 4 below).

Nationally the overall participation rates<sup>45</sup> of the 20–24 age cohort changed from 17% in 2009 to 22% by 2018. However, wide disparities remained in the participation rates of groups: African students from 13% in 2009 to 19% in 2018; coloured students from 14% to 15%; Indian students from 45% to 46%; and white students from 58% to 55%.<sup>46</sup>

At the first higher education summit, hosted in 2010 by the Minister, Dr Blade Nzimande, and the Department of Higher Education and Training (DHET), the call was for a re-examination of the collective understanding of the post-apartheid South African university. By 2015, and the second higher education summit, transformation was at the centre of discussions as student protests and the #FeesMustFall movement had spread to several campuses, the consequences of which undeniably heralded a new era for universities in South Africa.<sup>47</sup>

Although the profile of students who gained access to university studies had changed radically, this was not the case with institutional practices, culture and identities — both in terms of the curriculum and the academic success of students, and in terms of institutional transformation more generally.<sup>48</sup> The challenges that many students faced were sharply foregrounded, as were the intersections between different levels of disadvantage — class, race, gender, marginalised youth, disability, persons with HIV/AIDS.



<sup>41</sup> World Social Science Report. 2013. *Knowledge Divides. Summary*, June 2013, p.3.

<sup>42</sup> See, for example, the Organisation for Economic Cooperation and Development’s (OECD) evaluation of South Africa’s innovation policy (2007); and a year later, of the education system (2008).

<sup>43</sup> Council on Higher Education (CHE). 2016 & 2021. *VitalStats. Public Higher Education 2011, 2014, 2016 and 2019*. Pretoria. In both publications it is noted that the ‘unknown’ category is not displayed, but not omitted so rounded off percentages may not always add up to 100%.

<sup>44</sup> University of Pretoria. 2011. Group 4 Report, 15 November 2011, p.11.

<sup>45</sup> Participation rates are calculated, following the UNESCO formula, as a percentage of 20–24 years old in a population or population group enrolled in a national system of higher education.

<sup>46</sup> Council on Higher Education. 2011 & 2021. *VitalStats*, p.3 and p.4.

<sup>47</sup> Department of Higher Education and Training. 2010. Stakeholder Summit on Higher Education Transformation, 22–23 April 2010, Cape Peninsula University of Technology, Cape Town [https://www.dhet.gov.za/summit/Docs/General/Final%20HE%20Summit%20Information%20Booklet.pdf (accessed 28.03.2023)]; Report on the Second National Higher Education Transformation Summit: International Convention Centre, Durban, KwaZulu-Natal, 15–17 October 2015. Published January 2016.

<sup>48</sup> Report of the Ministerial Committee on Transformation and Social Cohesion and the Elimination of Discrimination in Public Higher Education Institutions, November 2008 (informally referred to as the ‘Soudien Report’).



# 4 | Higher education funding — an institutional perspective

Prof Carolina Koornhof, Executive Director, University of Pretoria

The higher education sector in South Africa is funded by three major income streams: government subsidies, tuition and accommodation fees, and third-stream income arising from contract research, consulting, continuing education, donations and grants.

From a quality of income streams perspective, government subsidies are regarded as income of the highest quality, and the University of Pretoria, similar to other universities in South Africa, is reliant on this income stream to fund operational and infrastructure costs in particular. Fees represent the second most valued income stream, but its quality is affected negatively by rising student debt that has escalated alarmingly in the sector since the #FeesMustFall campaign in 2015/2016.

Finally, the quality of third-stream income is generally regarded as having a lower value, given that specific limitations and restrictions are usually placed on such funds. These funds are often earmarked for specific outcomes and purposes, and are rarely available to fund operational and infrastructure expenses and historic student debt.

Figure 1.1 gives a comparison of income streams between 2009 and 2018.

During the period 2009 to 2018, the University of Pretoria positioned itself within this funding landscape with the purpose of optimising its share of government subsidies through improving throughput and student success, growing the student numbers in the STEM (Science, Technology, Engineering and Maths) disciplines, which are recognised as scarce skills, as well as growing the postgraduate student numbers, which are funded at higher levels in the subsidy formula. Investments in infrastructure in the faculties of Engineering, Built Environment and Information Technology, Health Sciences and Veterinary Science allowed the University to expand its capacity to accommodate strong growth in student numbers in the STEM disciplines. During the period, the University also grew its overall student numbers and the number of graduates that the University delivered to the market.

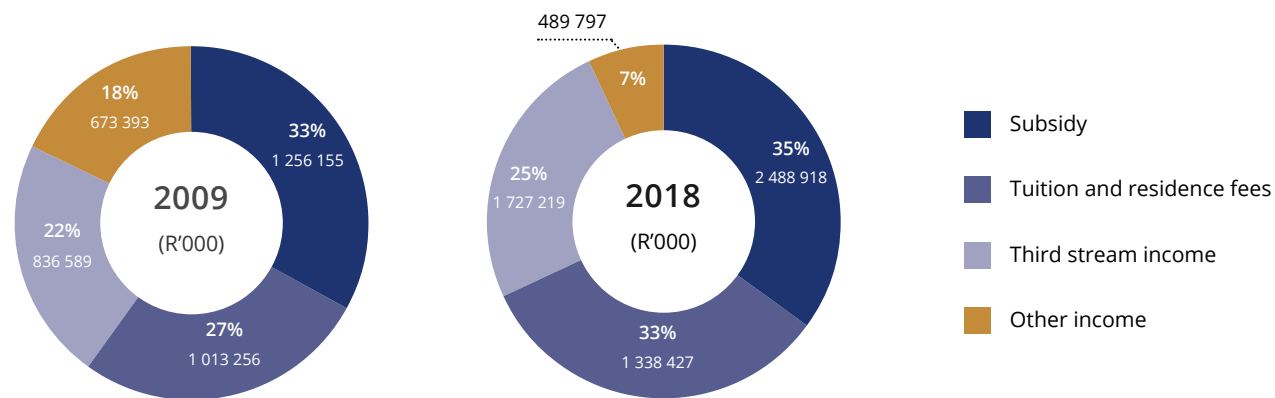

Figure 1.1. Comparison between UP income streams for the years ended 31 December 2009 and 31 December 2018

Table 1.3. UP graduates per major field of study, 2018 and 2009

Major field of study	2009	2018
STEM	30,4%	42,1%
Business	15,5%	22,8%
Humanities	18,8%	20,3%
Education <sup>49</sup>	35,4%	14,9%
<b>Total number of graduates</b>	<b>12 921</b>	<b>13 291</b>

Source: HEMIS files/HEDA

## Infrastructure investment

During the period 2009 to 2018, the University of Pretoria embarked on a number of large infrastructure projects to expand not only capacity in the STEM programmes already mentioned, but also to create platforms for transdisciplinary research, which is a strategic goal in the UP 2025 Plan.

The University received a generous donation from Michael Javett that, with additional UP funding, resulted in the construction of the prestigious Javett Art Centre at the University of Pretoria (the Javett-UP). The Art Centre has become a platform for transdisciplinary research, transformation and promotion of African Art. It is a secure venue to showcase the Mapungubwe Gold Collection, which is under the custodianship of the University of Pretoria Museums. The University also embarked on the building of Future Africa on the Experimental Farm, as a platform to engage with researchers on addressing transdisciplinary issues and problems relevant to Africa. Unfortunately, the completion of both projects significantly exceeded their original budgets when, among others, the construction companies themselves encountered sustainability problems.

## #FeesMustFall

The #FeesMustFall campaign in 2015/2016 had an extremely disruptive effect on the higher education sector as a whole and the University of Pretoria in particular on many fronts, including from a funding perspective. One of the first funding decisions made by the President of South Africa at the time, was that there would be no fee increases in 2016. This decision was funded by government as part of a ring-fenced amount in the government subsidy to support higher education institutions.

A second decision, again by the President of the country, which followed in December 2017, was to move from a partially funded, loan-based NSFAS funding scheme to a fully funded bursary funding scheme. This decision resulted in an exponential growth in NSFAS funding, which was partially funded by a declining block grant to universities and a delay in infrastructure grants. The result was a decline in the government funding per student in real terms over the period.

A related outcome of the Fallist movement was the decision taken by several universities, including the University of Pretoria, to insource service staff who had previously been outsourced. The University insourced a large number of security, maintenance, garden and food services staff on unfavourable financial terms. The financial impact of this decision on the University was profound. For the first time in recent years, the University became reliant on utilising reserves to fund its budgets, and its staff composition became seriously unbalanced with respect to academic, professional and service staff ratios. The total salary cost of the University also escalated in relation to total cost, from 46,8% in 2009 to 57,4% in 2018.

The impact of the insourcing on the financial position of the University was mitigated to some extent when Council approved a Financial Sustainability Plan for the University in June 2018, which was aimed at addressing the issues arising from insourcing, with measurable outcomes by 2025 to correct the imbalances. Financial Sustainability became the number one risk in the Risk Register of the University in 2018.

## Sustainability

In terms of the Higher Education Act (Act No. 101 of 1997), the Council of the University is responsible for the governance, strategy and sustainability of the University. The Vice-Chancellor is responsible for the management of the University and is also the Chief Financial Officer. The approval of the financial statements, budgets including fee increases, risk management and infrastructure investments, requires the approval of the Council of the University. Some of the responsibilities of the Council are delegated to the Vice-Chancellor and the Executive members, who, on a regular basis, report on progress and implementation.

The period from 2009 to 2018 was a particularly tumultuous one for the University of Pretoria in many respects, and

<sup>49</sup> The decline in percentage for the Faculty of Education is due to the decline in distance enrolments following the discontinuation of ACE programmes as a pathway to the BEEd (Honours) programme.



Credit: Lucinda du Toit

specifically, also from a financial perspective. A combination of factors — both within and outside the control of the University — placed additional constraints on University funding from a revenue stream, infrastructure cost and operational cost perspective, and impacted negatively on its long-term sustainability.

Sustainability was one of the key components of Prof De la Rey's inaugural address on 16 April 2010. She mentioned, inter alia, that "Sustainability and sustainable development are terms often used in today's society. Mostly, it is used to refer to the availability of material and tangible resources. ... material resources are critical, especially money. ... To enhance the affordability of our education, one of our challenges is to grow our resource base and to ensure that we utilise our available resources efficiently and effectively. Forging mutually beneficial partnerships with the business community

and public sector organisations will assist us in meeting this goal".<sup>50</sup>

Sustainability is one of the 'navigational markers' in UP 2025 that — along with quality, relevance and diversity — was identified as a 'balancing weight' in monitoring progress and ensuring that appropriate actions are taken in order to achieve the goals and targets set.<sup>51</sup>

Unfortunately, the outcomes of the #FeesMustFall movement acted as a serious stumbling block to achieving this goal. Notwithstanding the many challenges faced during the period, the University began recovering from the negative impact, using its Financial Sustainability Plan to guide not only the improvement of its financial position, but also the rebalancing of the shape and size of staff from a capacity and performance perspective.

## 5 | Transformation

UP 2025 positions transformation as an integral part of the University's development and strategic goals linked to planned enrolment growth, increased research output and relevance, strengthened international networks, impact on the country's socio-economic development, and teaching and learning that develops students and a critical citizenry. These themes are again picked up in Chapter 3 that focuses on the implementation of the University's long-term strategy.

Two perspectives are given:

- Leadership and the person at the helm of the University
- Student protests, and more especially, #UPRising, a reflection by the Editor of *Perdeby* (now *PDBY*), the student newspaper.

In August 2018, the Vice-Chancellor signed the University's Transformation Charter, the outcome of many iterative processes — a milestone that signalled the centrality of transformation in UP's daily practices and institutional culture. This is described in Chapter 3 and in Chapter 5, in the contribution from the Transformation Office.

### Leadership and transformation

*Edwin T Smith, member of the Editorial Board and campus manager, Mamelodi Campus*

### Leadership and change

As the Vice-Chancellor and Principal of the University of Pretoria from 2009 to 2018, Prof Cheryl de la Rey was, as indicated above, among many things the first black and the first female Vice-Chancellor and Principal of the University since its inception in 1908. While other institutions had appointed female and more particularly black female Vice-Chancellors before the University of Pretoria,<sup>52</sup> Prof De la Rey's appointment remains historically significant, not least because in the South African higher education landscape, the University of Pretoria was considered a historically white Afrikaans university. Given this context, it is understandable that much was anticipated and expected of her with regard to transformation. However, transformation, like other historical phenomena, means different things to different people at

different times and it would be unfair and inaccurate to assess Prof De la Rey's tenure and leadership against this narrow criterion.

For some, "transformation of higher education has been public discourse since the enactment of democracy in South Africa".<sup>53</sup> Apart from the obvious demands of transformation on any head of an academic institution in South Africa, Prof De la Rey appeared focused on improving the efficiencies and productivity of the institution, strengthening its knowledge-intensive identity in a networked society, and broadening its outlook through expanded strategic partnerships, more than simply transforming the University through mere numbers and demographics. Despite that, the student and staff profiles changed remarkably well during her tenure. For example, African students constituted 37,0% of the student body in 2009 and 48,2% in 2018, and African female students 54,1% in 2009 and 55,7% in 2018, while African staff constituted 29,9% of the UP workforce in 2009 and 55,8% in 2018.<sup>54</sup>

### The Fallist movement

The transformation of the higher education landscape in South Africa is a process that commenced well before Prof De la Rey's appointment as head of the University of Pretoria. Tethered to higher education policy development and implementation processes, transformation was generally conceptualised around the principles of equity and redress, democratisation, development, quality, effectiveness and efficiency, academic freedom, institutional autonomy and public accountability. Among other views, André Keet writes that "recent demands for 'transformation' come from a wide range of quarters and are articulated in varied forms, but do not appear to be fundamentally different in substance and style from similar calls made at various periods over the past 20 years".<sup>55</sup>

<sup>50</sup> Installation of Vice-Chancellor and Principal, Prof Cheryl de la Rey, 16 April 2010.

<sup>51</sup> See UP 2025 and subsequent planning frameworks, e.g., the UP Plan for 2013. An Overview of Strategic Priorities, October 2012, p.26.

<sup>52</sup> The University of Natal appointed Prof Brenda Gourley as its Vice-Chancellor in 1994, thereby making her South Africa's first female Vice-Chancellor; the University of Cape Town appointed Prof Mamphela Ramphele as Vice-Chancellor in 1997, thereby making her South Africa's first black female Vice-Chancellor.

<sup>53</sup> Grace Khunou, Chair of the Scientific Committee, University of South Africa's Department of Leadership and Transformation's call for abstracts for the conference, Transforming Scholarship after Covid-19 and in the Context of 4IR, 21–23 November, 2022.

<sup>54</sup> University of Pretoria, Department of Institutional Planning, 2022.

<sup>55</sup> A Keet. 2015. Briefing paper prepared for the second national Higher Education Transformation Summit, 15–17 October 2015, pp.4&5.

He writes that "Reflections on higher education transformation in South Africa generally choose the policy starting-points reflected in the report of the National Commission on Higher Education (NCHE, 1996); the *White Paper* on Higher Education (1997); the Higher Education Act (1997); the National Plan for Higher Education (2001); the Report of the Ministerial Committee on Transformation and Social Cohesion and the Elimination of Discrimination in Public Higher Education Institutions (2008); the Declaration of the Higher Education Summit (2010); the National Development Plan (2012); the terms of reference of the Ministerial Oversight Committee on Transformation in South African Public Universities (2013); and the *White Paper* for Post-school Education and Training (2014)".

Notwithstanding, the Fallist movement and its activities were a significant turning point in how both the leadership at the University of Pretoria and in the South African higher education sector dealt with transformation. Commencing in March 2015 at the University of Cape Town in the #RhodesMustFall student protests, the Fallist movement soon engulfed the entire higher education sector in South Africa, with reverberations as far as the United States of America and the United Kingdom.

Unlike Keet who proffers a more sympathetic and supportive notion — and the student's view below, others have viewed the Fallist movement as the 'nadir of transformation' in higher education.<sup>56</sup>

### A turning point

While it is important to understand the spaces Prof De la Rey used to embed her leadership and shift institutional practices, it is the Fallist movement that remains the undeniable marker of the time, at universities in South Africa, and at the University of Pretoria. The movement is only paralleled by the June 1976 student uprising, which had a profound impact on South African struggle history.

As a result of its profound impact, several of Prof De la Rey's contemporaries in the South African university sector produced book-long interrogations of their experiences with and understanding of the Fallist movement, its consequences and aftermath for the higher education sector in the country.<sup>57</sup>

Interpreting the full extent of this turn in higher education is an ongoing process. As can be expected, there continues to be a chorus of different voices and views dancing on the horizon, jostling for dominance and supremacy. In the most recent account, Prof David (D) Benatar (2021) documents a detailed timeline of the Fallist movement from its dramatic inception in 2015 to recent times. However, for Benatar, the "precipitous downward trajectory began, but did not end, with the criminal protests from 2015 to 2017".<sup>58</sup>

Responses to the Fallist movement offer insights and a nuanced understanding of its effect on transformation in institutions of higher education. However, it is important to

### Notable leadership responses

Prof Jonathan Jansen, Vice-Chancellor and Principal at the University of the Free State at the time, met with eleven of his peers, including Prof De la Rey, to conduct in-depth interviews with them on their experiences and views of this phenomenon during their time as heads of South African higher education institutions affected by the Fallist movement phenomenon.<sup>59</sup>

Prof Adam Habib, Vice-Chancellor and Principal of the University of the Witwatersrand (Wits) at the time, reported on his experiences with the Fallist movement at his institution as well as in the broader higher education context. Prof Habib's treatise was greeted with dissent and protest. Among these, a number of colleagues at Wits University published an open letter in the *Mail & Guardian* documenting their disagreement with his views.<sup>60</sup> In his endeavour, Prof Habib attempted to provide a deeper understanding of the crisis in higher education and the inappropriateness of the movement's strategies and tactics in addressing the crisis, especially in light of what he considered a one-sided and shallow discourse in the public domain regarding what was happening at universities across the country and in higher education in general and how to fix it.

acknowledge that the protests commenced from historically black universities around the issues of the unaffordable cost of higher education for the historically disadvantaged in the country, but only received greater public attention when these protests progressed to historically white English universities such as the University of Cape Town with the spectacular attack on the Rhodes monument.

The protests reached the University of Pretoria through the #UPRising protests in 2015, and in 2016/2017, the #AfrikaansMustFall wave of student protests at UP and historically white Afrikaans universities. This latter trajectory presents another dimension to the crisis in higher education in South Africa, i.e., the politics, culture and complexities of transformation that Prof De la Rey had to contend with during her leadership of the University of Pretoria.

### Significant identities

Being a woman and black, as noted earlier, were two absolutely significant identities Prof De la Rey brought to the University of Pretoria. However, there were several other ways in which she had to navigate institutional culture and leave her mark in what hitherto had been presented as 'transformation' at UP, and which in multiple ways have left a greater imprint on the institution beyond her tenure. UP in 2009/2010 was arguably very much an institution dominated by men — white, Afrikaans, conservative, church-orientated men, and organised around the institutional practices that, some would argue, defined an efficient bureaucracy.

Notwithstanding, Prof De la Rey's noteworthy contribution in the academic project of the institution, which led to her winning the 2017 businesswoman of the year award,<sup>61</sup> she also embedded her leadership in areas uncharacteristic or at least new in the university landscape. This is significant because for some "what lurks behind the pleasant veneer of the impeccably manicured gardens at UP are markers of belonging and privilege that are somewhat less apparent".<sup>62</sup>

Prof De la Rey was variously invested in the sports culture of the University. She was greatly visible in rugby, soccer, swimming, athletics and what was happening in these sports codes at the institution. Furthermore, she demonstrated a keen interest in the arts, which among other things led to the establishment of the Javett-UP Art Centre that informs, promotes and develops the arts enterprise in South Africa and on the continent. Prof De la Rey promoted transdisciplinarity in the academy, which, among other things, resulted in the creation of Future Africa as a multi-, inter-, and transdisciplinary research platform focused on the African continent. She was also a founding member of the

Australia–Africa University Network (AAUN), which sought to foster partnerships between universities across the country and continent with Australian universities to build research capacity and projects to the benefit of both continents. This particular endeavour constitutes a different postulation of the south-south relations in the higher education sphere, which is normally characterised by north-south relationships.

### Doing things differently

Consequently, Prof De la Rey did things differently during her time at the University of Pretoria. Not only did she have an open-door policy to the Student Representative Council (SRC), for some she also affected the way a Vice-Chancellor looked, dressed, and behaved, which was refreshing and inspiring in many ways. In this regard, she also launched a fitness walking trail on the Hatfield Campus to promote healthy lifestyles and living in the university community. She did all this while putting out raging fires all over the institution and the higher education landscape as a result of the Fallist movement, which, some may argue, greatly affected her relationship with a section of staff and students at UP.

For many observers, the behaviour and conduct of some of the students and workers during this time left much to be desired and tested and strained many relationships, regardless of the acknowledged legitimacy of their concerns and quests.

The swift and decisive locking down of the campuses resulted, among other things, in limiting the physical damage to the University's infrastructure. This was seen by some as 'militarising the university', and detracted from what was an excellent leadership tenure. With hindsight, many now credit her actions with saving the institution from the devastation

<sup>56</sup> D Benatar. 2021. The fall of the University of Cape Town: Africa's leading university in decline, *Politicsweb*, pp.415–421.

<sup>57</sup> See J Jansen. 2017. *As by fire: The end of the South African university*, Tafelberg, Cape Town; and A Habib. 2019. *Rebels and Rage: Reflecting on #Feesmustfall* (Jonathan Ball Publishers, Johannesburg).

<sup>58</sup> D Benatar. 2021, p.1.

<sup>59</sup> J Jansen. 2017, p.x.

<sup>60</sup> S Ally et al. 2019. An open letter to the readers of Adam Habib's 'Rebels and Rage', *Mail & Guardian*, 1 April 2019. <https://mg.co.za/article/2019-04-01-an-open-letter-to-the-readers-of-adam-habibs-rebels-and-rage/> Accessed: 22 July 2022.

<sup>61</sup> Anon, UP Vice-Chancellor is Businesswoman of the Year winner for Education, 11 September 2017. [https://www.up.ac.za/business-management/news/post\\_2556244-up-vice-chancellor-is-businesswoman-of-the-year-winner-for-education#:~:text=University%20of%20Pretoria%20\(UP\)%20Vice,cereemony%20in%20Sandton%20last%20week.](https://www.up.ac.za/business-management/news/post_2556244-up-vice-chancellor-is-businesswoman-of-the-year-winner-for-education#:~:text=University%20of%20Pretoria%20(UP)%20Vice,cereemony%20in%20Sandton%20last%20week.) Accessed: 22 July 2022.

<sup>62</sup> S O'Connell. 2022. UP can stake its place as a benchmark space of higher learning in, and of, Africa. In M Crewe (ed.), *Institutional Curiosity*, ESI Press, Pretoria, p.13.

the Fallist movement and its various iterations caused the higher education landscape across the country. Reports from the Department of Higher Education and Training indicate the total damage to institutions across the country as a result of the Fallist movement protest actions amounted to almost R800 million rands.<sup>63</sup>

Notwithstanding UP's long history of transformation from its inception as an English institution in 1908 to its 'Afrikaanswording'<sup>64</sup> when "in 1932, the University Council declared that Afrikaans should be the only medium of instruction",<sup>65</sup> to the University being a dual medium — Afrikaans and English — university in the 1990s, and then an English and Afrikaans university in the 2000s, to the current language of instruction disposition that continues to be reviewed as keeping up with the changing and evolving sensibilities of the state, UP has always been a 'volksuniversiteit'.<sup>66</sup> Although this took on a different form from 1994, UP has remained an engaged university in service of society and the 'public good'<sup>67</sup>. This is perhaps the fate of a public university, and its leaders will ultimately be judged on how best they served and executed this role.

### Universities and leadership

Universities claim a higher calling as generators of new knowledge to move society forward. In South Africa, this implies being responsive to local contexts and needs. With the legacy of colonialism and apartheid being a living reality in the racial disparities that continue to plague South Africa, the challenge of transforming institutions to reflect the best of society continues unabated. What often gets lost in the quest of being all things to all people, is the need to be something worthwhile to the country and the higher education sector. Often, South African higher education institutions seem to pursue a cookie-cutter approach to both innovation and transformation in the sector. From their vision and mission statements to their strategic plans, our institutions are often indistinguishable from one another.

In some sense this may be the reality given that they all serve the same country and people that have to contend with the same opportunities and challenges. However, one cannot deny the yearning for an institutional leader who not only looks different but is actually different and brings that difference to bear on the institution they lead. This might be

too tall an order for any vice-chancellor anywhere. But the University of Pretoria needed such a leader if it was to make any advances on the promise it holds to future generations of students and staff at the institution. By all accounts, Prof Cheryl de la Rey presented the University of Pretoria such an opportunity during her tenure.

### Perdeby — students' voice

Unique perspectives, edgy content, and a reflection of student life has been the maxim of the *Perdeby* newspaper since its first edition in 1939. The mandate is to inform and entertain but what has always set the newspaper apart from mainstream media is the focus on content that matters to students.

Although the publication serves as a development platform for student journalists, its readers have always held these students to the same high standards as they would seasoned professionals. In 2015 and 2016, *Perdeby* journalists stepped up to the challenge by reporting on events that would dramatically impact and change universities across South Africa. It could be argued that the content produced during

this period was on par with that of mainstream publications, and in some instances better, because of the access student journalists had to the protests, paired with the unique angles they took in telling students' stories.

Over the years, *Perdeby* has proved itself to be a journalistic watchdog on campus through being the voice of Tuks students.

As the images that conclude this chapter show, and the text by the then Editor, Dr Michal-Maré Linden, being at the coalface of the #UPRising protests generated unique vantage points from which to view this period in the history of the University of Pretoria.

*Carel Willemse, Editor-in-Chief of Perdeby, now PDBY*

### #UPRising — a student journalist's view

*Dr Michal-Maré Linden*

On Friday, 16 October 2015, *Perdeby* (now recognised as *PDBY*) held their annual awards evening. Prizes were handed out for 'Article of the year', 'Best photo' and 'Section of the year'. While we celebrated late into the night, none of us were aware that a week later we would be nursing sunburn, exhaustion, and the effects of pepper spray and rubber bullets. We were also ignorant that the best was yet to come.

The 2015 #FeesMustFall protests at the University of Pretoria, which fell under the name #UPRising, lasted only a week. It was the most significant news week *Perdeby* had seen in years. When I started my tenure as Editor in September 2014, I envisioned a newspaper that broke away from student fluff about drinking, drugs, and bars. It may have seemed terribly boring, but I had, after all, grown up reading *Time*, and not *Seventeen*.

No one pushed back too hard on this vision. Our staff consisted largely of students born between 1993 and 1995, democracy babies, and they had an awareness about them that was palpable. While it meant there were sometimes heated political arguments in the layout room, it also meant that we understood that journalists had a great responsibility — we were just waiting for our moment.

When the protests broke on campus, the transformation happened almost instantly: sports journalists became hardened newshounds, entertainment writers became professional social media managers, and our copy editors traded pen for phone as they live-streamed the action while dodging rocks. We worked around the clock, sometimes in



<sup>63</sup> L Dentlinger, #FeesMustFall damage costs soar to nearly R800m, *Eyewitness News*, 8 August 2018.

<sup>64</sup> *Afrikaanswording* meaning 'becoming Afrikaans'.

<sup>65</sup> S O'Connell. 2022, p.12.

<sup>66</sup> 'Volksuniversiteit' meaning a university of the nation or state. FA Mouton. 2004. FJ du Toit Spies, Afrikaner Nationalism and *Volksgeskiedenis* at the University of Pretoria, *South African Historical Journal*, 51(1), p.95.

<sup>67</sup> ET Smith. 2021. Education and the public good: Foregrounding education in history, *Yesterday & Today*, 26, December 2021, p.47.

physical danger, to produce news content not seen in any mainstream media, most especially because our content focused on students and their plight.

While certain well-known publications exclaimed that “security guards fled from students”<sup>68</sup> and protesters “went on a rampage”<sup>69</sup>, our journalists were constantly on the ground to set the record straight: that the protests were calm and intelligent, that they had damaged no infrastructure, and that their cause was inspired by justice and empathy for the poor. *Perdeby* provided a direct line to student protesters that no other publication had, and the more time we spent with the protesters, the more our compassion grew. We handed out water as they stood in the hot sun and ensured that identities would not be compromised if they spoke to us. We were no longer ‘student journalists’, but ‘students’ and ‘journalists’.

While some may criticise our actions, I think that the protests made us realise what the epitome of being a journalist is. A journalist is motivated to help, to showcase injustices and

community issues. They use their agency and creativity to give a voice to the voiceless. On 23 October 2015, when President Zuma announced a moratorium on fees for 2016, we too felt a wave of success. I believe, even if it is in some small part, our reportage helped recognise the humanity of students, and remember their history-making efforts forever.

This all seems utopic, and 2015’s protests were in comparison to what followed. UP saw the #AfrikaansMustFall and #FeesMustFallReloaded protests in February and August to October of 2016, respectively. These protests were violent and polarising, resulting in injury, damage to property, the securitisation of campuses, and a stronger pushback to the movements’ core messages. Even still, *Perdeby* journalists applied the skills learned in 2015 — professionalism and discretion — to focus on the core issues, instead of getting swept up in the drama of movements that were no longer student-led and underlain with ulterior motives and political agendas.

Michal-Maré Linden, Editor of *Perdeby* in 2015 and 2016, completed her master’s degree in 2017. Her thesis, supervised by Prof Corinne Sandwith in the University’s Department of English, is titled “Narrating the 2015 ‘FeesMustFall’ movement: explanations, contestations, and forms of meaning-making in the public sphere”.



Credit: Perdeby



CHAPTER 1 | Context

Credit: Perdeby

l to r: Mosibudi Rassie Rasethaba (SRC President), Thabo Shingange (SRC Deputy Secretary), Michael Bongani Reinders (SRC Residence), Amla Monageng (student activist), Huvasan Reddy (*Perdeby* journalist)

<sup>68</sup> eNCA. 2015. 'Security runs for cover as Tuks students protest'. 21 October. [Online] Available at <https://www.enca.com/south-africa/security-runs-cover-students-protest> [Accessed 20 March 2023].

<sup>69</sup> T Makhetha and R Moatshe. 2015. 'Fees fight hits city'. *Pretoria News*, 22 October, p.1.

# Governance

- 1. Governance, in overview
- 2. Council
- 3. Senate
- 4. Institutional Forum
- 5. Student Governance
- 6. UP Executive and Senior Management
- 7. Office of the Registrar

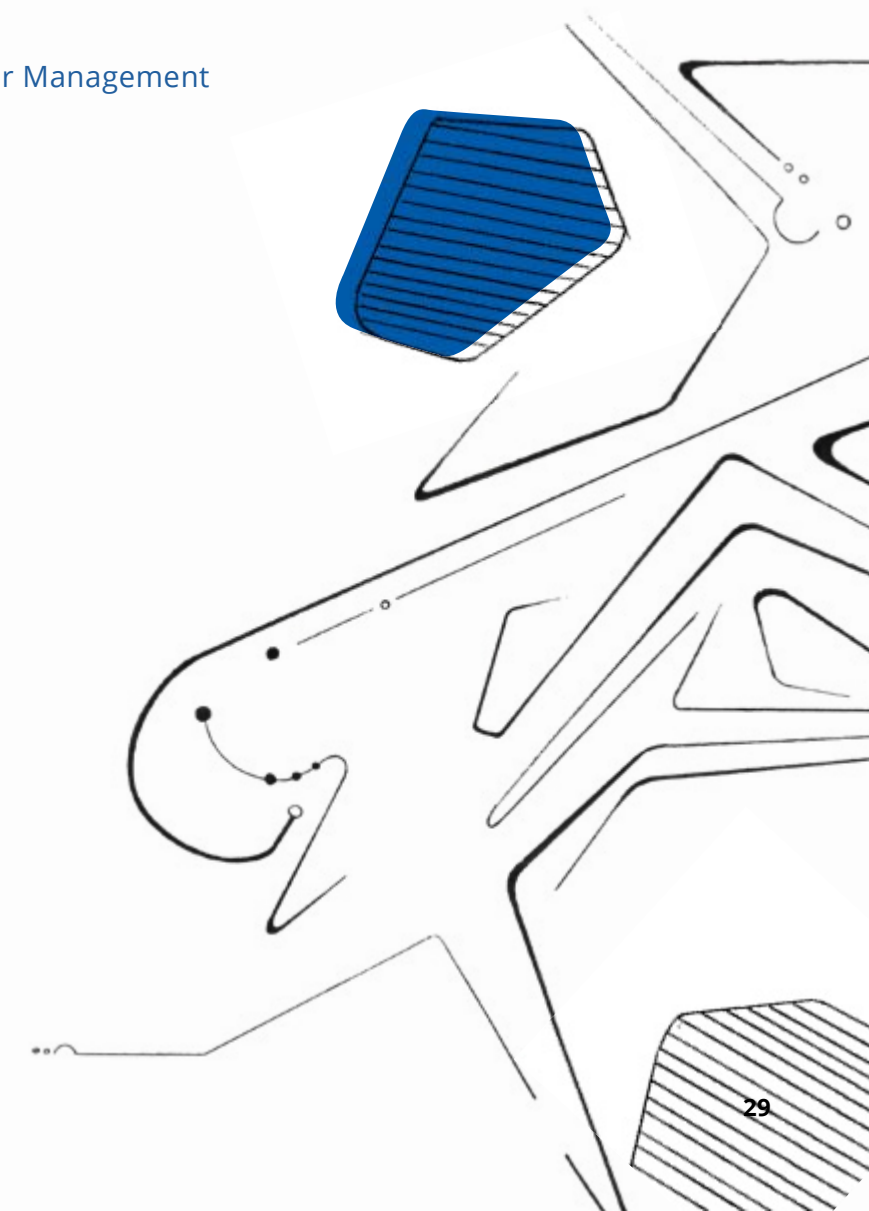
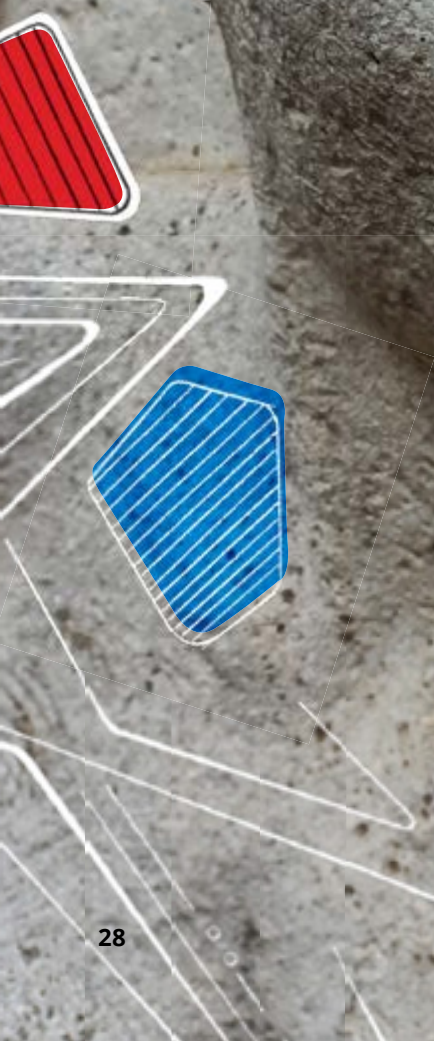

- Human Resources Committee
- Audit, IT and Risk Management Committee
- Investment Committee



- Faculty Boards
- Academic Planning Committee
- Senate Review Committee on Re-admission
- Senate Committee for Teaching and Learning
- Senate Committee for Student Life
- Senate Committee for Research Ethics and Integrity
- Senate Committee for Research and Postgraduate Education
- Senate Selection Committee for Honorary Degrees
- Senate Central Admissions Committee
- Inter-Faculty Academic Committee - Mamelodi Campus

- Deans' Committee
- Directors' Management Committee
- Institutional Transformation Committee
- Operational Risk Management Committee
- Planning and Budget Committee
- Strategic Risk Management Committee
- Committee for Financial Aid and Bursaries
- Facilities Advisory Committee
- Student Affairs and Residence Accommodation Operations Management Committee

Figure 2.1. Governance structures of the University of Pretoria

# 1 | Governance, in overview

The governance of South Africa's public higher education institutions is prescribed by the Higher Education Act (Act No. 101 of 1997, as amended), and by the individual statutes of universities. Council and Senate are considered the apex structures vital to the well-being of institutions, each with clearly delineated roles and responsibilities.

As reported in Chapters 1 and 3, the higher education sector experienced great volatility during the review period, as a result of the nationwide #FeesMustFall student protests, the impact of which would be felt for years to come. By 2018, several higher education institutions were experiencing considerable challenges; some were under administration. Despite the sector-wide crisis, the institutional context of the University of Pretoria remained stable, although critical decisions had to be taken. This stability was in no small measure due to strong leadership within the University, and at each of the apex governance levels, and the Vice-Chancellor and Principal's close relationship with the Chancellor and the Chair of Council.

Since the early 1990s, good governance has received considerable attention. This was no surprise in post-apartheid South Africa as institutions needed to be rebuilt

and governance structures and processes had to adhere to the values and principles of a new Constitution and young democracy to ensure that transformation would be achieved. For the higher education sector, the work of the National Education Policy Initiative (NEPI), followed by the National Commission on Higher Education (NCHE), laid the groundwork for what was termed 'cooperative governance'.<sup>1</sup>

The University sustained good governance practices through a number of key Council and Senate committees, as well as committees at faculty and departmental levels. Framed by UP 2025 and continuous one- and five-year planning cycles, institutional actions became well-anchored in the University's formal governance structures and processes.

The organogram on the left gives an overview of the governance structures of the University of Pretoria.



<sup>1</sup> See Chapter 1.

The sections in this chapter elaborate on:<sup>2</sup>

- Council, the apex governance structure for oversight and policy approval
- Amendments to the UP Institutional Statute
- Senate, the highest academic governance structure
- Advisory bodies, with a specific focus on the Institutional Forum
- Student governance and representation, with a specific focus on the Student Representative Council (SRC)
- The Executive, responsible for strategic leadership, decision-making and operational management
- The Registrar’s Office, with a focus on, inter alia, governance, compliance, policies, legal services, information governance and the UP Archives.

### The Chancellor

The Chancellor of the University of Pretoria is the titular head of the institution, elected by an electoral college consisting of members of Council, Senate, and the President of the Convocation. The Chancellor is a respected senior public figure with a notable reputation and values aligned with the identity of the University. The role does not involve any executive powers or administrative duties. The term of office is five years. In essence, the Chancellor is the ‘face of the University’ and fulfils key ceremonial functions at graduation and other ceremonial gatherings.

Prof Wiseman (WL) Nkuhlu served as the Chancellor of the University of Pretoria for the duration of the review period, 2009 and 2018. Installed to this position in 2007, he was the first black Chancellor of the University and served the institution most admirably throughout his term, which was renewed twice — in 2012 and again in 2017.

### Chancellor’s Medal

The Chancellor’s Medal is a prestigious award made to individuals who have excelled in areas which are broader than the purely academic, such as the arts, welfare services, industry and innovations. The Council approved 13 Chancellor’s Medal Awards during the period 2009 to 2018.<sup>3</sup>

Prof Nkuhlu is renowned as South Africa’s first qualified black chartered accountant. From 1998 to 2000 Prof Nkuhlu was president of the South African Institute of Chartered Accountants (SAICA). He served as an economic advisor to President Thabo Mbeki’s administration from 2000 to 2004 and chaired the Development Bank of Southern Africa’s transition team from January to May 1995. He was also the first Chair of the Council on Higher Education (CHE) and the president of the Black Management Forum. From 2010 to January 2018 he chaired the multinational investment bank and financial services company, NM Rothschild & Company in South Africa.



## 2 | Council

As the apex governance structure, the UP Council is responsible for ensuring the stability, strategic direction, financial health and a positive public image of the University. Council members collectively and individually, have a fiduciary responsibility towards the University and the public.

### The Chair of Council

The Council elects the Chair of Council from the ranks of its external members. Futhi (NT) Mtoba was appointed as a member of Council in 2007, on the basis of her experience, and expertise. In 2008, she succeeded Prof Esmé (ED) du Plessis as the new Chair of Council, a position she held for the entire review period. She is a chartered accountant who has received several distinguished awards, including the 2008 TuksAlumni Laureate Award, for her impactful work in the field and for her outstanding leadership as a businesswoman. She was the University’s first black Chair of Council, a position she held with distinction.



As Chairperson of the University Council, she was an ex officio member of the Council’s Human Resources Committee, Standing Committee and Investment Committee.

### Membership of Council

Council comprised the following during the review period:

- the Vice-Chancellor and Principal, and Vice-Principals as ex officio members
- not more than five persons, appointed by the Minister
- three members of Senate, elected by Senate
- two employees, elected by the relevant category of UP employees
- two students, elected by the SRC
- six members, appointed on the basis of their expertise and experience
- one member, appointed by the local municipal authority
- four members, elected by the Convocation
- two members, elected by the donors of the University.

Futhi Mtoba started her professional career at WL Nkuhlu & Co in association with Hoek & Wiehelm before joining what was then known as Deloitte & Touche in 1988. She rose up the ranks to become the firm’s first black female partner and, subsequently, chairperson at Deloitte Southern Africa. In due course, she became President of the Association for the Advancement of Black Accountants of Southern Africa. She also served on the Board of the Nelson Mandela Foundation and as Chairperson of the National Anti-Corruption Forum. In 2014, Ms Mtoba, received an honorary doctorate from the University of Limpopo in recognition of her contribution to society and to the accounting profession. She was also appointed to the African Union Foundation, established by the African Union Assembly, which aims to finance African priorities through voluntary contributions.

<sup>2</sup> The text is adapted from extensive notes prepared by Michelle Viljoen, and informed by the UP Institutional Audit Self-Evaluation Report, May 2022.

<sup>3</sup> See Appendix B for the list of the recipients.



In addition to the Chair of Council, the individuals who served as members of the University Council between 2009 and 2018 are listed in Appendix D. With the exception of ex officio members and student representatives on Council, the term of office of Council members is four years.

### Council meetings

In line with statutory requirements, three ordinary Council meetings are held per year, normally in March, June<sup>4</sup> and November. In addition, a strategic Council workshop is held every year to deliberate on matters of strategic importance to the University. In overview, Council is responsible for:

- overseeing and monitoring institutional policy, including admission and language policies
- formulating guidelines relating to strategic and financial governance
- evaluating performance and risk assessment; and
- overseeing matters of staff and student discipline; and fostering a positive academic atmosphere.

During the review period, 2009 to 2018, only one extraordinary meeting of Council was held — on 27 February 2016, when it was necessary to discuss the way forward, following violent protests under the banner of #FeesMustFall. At that meeting, Council approved the establishment of an independent Transformation Panel for multi-stakeholder consultation on transformation issues at the University.

### Assessment of performance

All reports confirm that the Council and its committees functioned well in this review period, with the quorum met for meetings. Processes ran smoothly, and no rules of conduct were transgressed. As mentioned earlier, the successful functioning of UP's Council can, in large part, be attributed to the close working relationship between the Chair and members of Council, the Vice-Chancellor and Principal, and to a well-functioning Office of the Registrar.

Members of Council were well-prepared for their role in UP's institutional governance and oversight. Once elected or appointed to Council, individuals attended an induction session with the Registrar where regulatory documents, including the UP Statute, and information on committees were shared. Members therefore had a clear understanding of the roles and responsibilities of Council, the higher education context in which the University operated, and of

the terms of reference of Council Committees. An annual performance self-assessment of the functioning of Council provided a further opportunity for feedback.

### Special honours

Two Council members were honoured for their business leadership and contribution to South Africa's economic growth in the 2014 Sunday Times Top 100 Companies Awards. Laurie (L) Dippenaar, Chairperson of FirstRand financial group, received the Sunday Times Business Times Lifetime Achiever Award in 2013. Former UP Vice-Chancellor and Principal, and Group Chief Executive Officer of Sanlam, Dr Johan (J) van Zyl, was voted 2014 Sunday Times Business Leader of the Year. In 2017, he was named UP's Agriculturalist of the Century.

### In memoriam

The former Chair of Council for the period 1999 to 2003, Ben (BC) Alberts, passed away in April 2013. He was president of the UP Alumni Association from 1988 to 1992, and member of Council elected by the Convocation in 1988. During his long association with the University of Pretoria he left a meaningful legacy through his national impact on the mining sector and the Department of Mining Engineering, his key role in the rebuilding of Kya Rosa on the Hatfield Campus, his service on the Convocation, the Audit Committee of Council and the University Council, and his personal contributions to the bursary fund for historically disadvantaged and financially needy students.

### Council Committees

In this period, there were five Council Committees, each with a mandate of strategic or financial significance, chaired by individuals with appropriate skills and experience:

- Standing Committee of Council
- Human Resources Committee of Council
- Investment Committee of Council
- Audit and Risk Management Committee of Council (later the Audit, IT and Risk Management Committee of Council)
- Joint Committee of Council.<sup>5</sup>

Council Committees report to Council at each ordinary Council meeting. The Charters and delegations of Council Committees were updated and revised in 2011, 2013 and 2017.

### Standing Committee of Council

The Standing Committee of Council (SCC) serves as the executive committee of Council and may act as the representative of the Council when it is not in session and may assume the authority and act on behalf of the Council in urgent matters. The seven-member Committee was chaired by Dr Piet (BP) Botha from 2010 to May 2018.

### Human Resources Committee of Council

The Human Resources Committee of Council (HRCC), which exclusively comprises external members of Council, regulates all aspects related to appointments, remuneration, conditions of service, and performance of all employees, ensuring effective delegations to the management where applicable, and makes recommendations to Council for approval. The Committee comprised seven members, including the Chair and Deputy Chair of Council (ex officio). Anton (AD) Botha was the Chairperson of the Human Resources Committee of Council in 2009. In 2010 Dr Steve (SF) Booysen was elected as Chair and served in the role until November 2018.

The Senior Appointment Committee (Academic) and the Senior Appointment Committee (Academic Management) support the Human Research Committee in its role.

### Audit and Risk Management Committee

The primary role of the Audit and Risk Management Committee of Council is to ensure that the University's executive leadership continually implement effective internal control systems to minimise material risks and prevent losses, and to ensure that the University acts with integrity with regard to financial transactions and reports. The Committee comprises four external Council members, and meetings are attended by the Vice-Chancellor and Principal, the Executive Director responsible for Finance, and the Director: Finance by standing invitation. Dr Piet Botha chaired the Committee between 2009 and 2017. He was succeeded by Israel (IB) Skosana who was elected to chair the Committee from March 2018. In 2013, the Charter of the Committee was amended and the mandate expanded to include Information Technology (IT) and the Committee became the Audit, IT and Risk Management Committee of Council. Dr Danie (DM) Behr was appointed as an additional member based on his expertise and experience in the field of IT.

### Investment Committee of Council

The Investment Committee of Council is charged with determining the investment policy and strategy and overseeing the investment portfolio of the University. The Chair of Council, Vice-Chancellor and Principal, Executive Director: Finance and the Director: Finance are ex officio members of the Committee. Additional members include Vice-Principals and advisors nominated by the Vice-Chancellor and Principal, at least three external members of Council appointed by the Chair of Council, and at least one competent full-time academic member of staff appointed by the Chair of the Investment Committee. The Chancellor has a standing invitation to attend the meetings of the Committee. Anton (A) Botha served as Chair of the Investment Committee of Council during the review period.

### Joint Committee of Council

Since 2010, and in accordance with regulations, the SCC and HRCC sit together as a Joint Committee of Council to consider the appointment of the Vice-Chancellor and Principal and the Vice-Principals. The JCC interviews candidates and makes recommendations on appointments to the Council.

<sup>4</sup> In 2010 the FIFA Soccer World Cup was hosted in South Africa, and the date of the June Council meeting was moved to August 2010.

<sup>5</sup> The JCC is a joint sitting of the SCC and the JRCC, convened to deal with appointments at executive level (Vice-Chancellor and Vice-Principals).

## Important decisions of Council

There were several standing matters on the agenda of the Council. These included the approval of the annual budget; financial reporting to the DHET; enrolment planning and efficiency targets; Employment Equity Reporting to the Department of Labour; institutional risk analysis and risk treatment plans; and all reports submitted by Council Committees and Senate.

Between 2009 and 2018, a significant number of specific items within the mandate of Council, and which had a lasting impact on the University, were considered. These included, among others:

- In March 2009, the approval of the designation of the post of Senior Vice-Principal to support the Vice-Chancellor and Principal in positioning the University on an international level and focus more on external matters. Council approved that Prof Chris (CR) de Beer be the designated appointee. Over this period, Council also considered and approved the appointment of several members of the Executive (see Section 6 below).
- In 2011, Council approved amendments to the regulations and procedure for the appointment of Vice-Principals, and the appointment of Deans and Deputy Deans. In the same year, Council approved the University's long-term strategic plan, UP 2025; and in subsequent years, consecutive one- and five-year plans.
- In November 2012, Council approved the Campus Master Plan, which became the blueprint for infrastructural development in support of the University's future growth and research strategy. In view of the large capital amounts involved for some of the projects, Council had a particularly important fiduciary responsibility in this regard.<sup>6</sup>
- Council approved changes to the UP Statute in 2010, 2011, 2012, 2016 and 2018.
- Changes to the Constitution for Student Governance became a regular feature on the agenda of Council. The

Constitution for Student Governance, approved in 2010, was replaced in 2014, and amended in 2015 and 2018. Council approved the appointment of Temporary Student Committees (TSCs) for 2010, 2012, 2013 and 2017. A TSC is established as an extraordinary temporary measure in the case where a free and fair election of the SRC cannot be concluded.

- Among the most far-reaching decisions of Council was the review of the University's language policy (2015/2016), resulting in English becoming the primary language of instruction, from 2019. This was a controversial decision and, in the view of some, was a retrogressive step for the University with respect to the multicultural language identity it pursued.<sup>7</sup>
- The reports by the Independent Transformation Panel of Council, led by Justice Johann van der Westhuizen, served before Council in June and November 2016, and informed subsequent decisions of a transformational nature.<sup>7</sup>
- In November 2018, Council approved the amendment of the 2000 policy on the naming of chairs, buildings and other university facilities.
- Linked to the Fallist movement, was the large-scale insourcing of campus services in March 2016, placing the financial sustainability of the University at risk.

## Convocation

In accordance with statutory provisions, Convocation has the role of ensuring that alumni input is obtained in matters affecting the University and it provides the formal link to alumni of the University. It plays an advisory role and was represented on the University Council by elected members. Retired Judge Frikkie (CF) Eloff<sup>8</sup> served as president of the Convocation from October 1994 to 2012. He was succeeded by Leo (LA) Haese<sup>9</sup> in 2012. The position was vacant in 2018.

During this period, a new constitution was drafted for TuksAlumni. The election of a new president of the Convocation was postponed and new institutional rules for



From l to r, first row: Danai Magugumela, Dr Piet Botha, Prof Cheryl de la Rey, Futhi Mtoba, Kuseni Dlamini, Prof Russell Loubser  
second row: Prof Norman Duncan, Prof Stephanie Burton, Neo Lesela, Vuyelwa Qinga, Dr Barbara-Ann Ribeiro, Kedibone Diale, Soraia Machado, Allan Taylor  
third row: Cilliers Brink, Danie Behr, Appie Pienaar, Prof Innocent Pikirayi, Israel Skosana, Kwena Moloto, Prof Themba Mosia, Dr Steve Booysen  
fourth row: Laurie Dippenaar, Dr Johan van Zyl, Prof Caroline Nicholson, Prof Carolina Koornhof, Anton Botha, Prof Sunil Maharaj, Prof Anton Ströh, Prof André Borraine

<sup>6</sup> See [Facilities Management](#) in Chapter 5.

<sup>7</sup> See Chapter 3, [Section 7](#).

<sup>8</sup> Christoffel Frederik 'Frikkie' Eloff SC (31 January 1925–10 December 2017) was a South African judge who served as Judge President of the Transvaal Provincial Division of the Supreme Court of South Africa from 1991 until 1998.

<sup>9</sup> Prominent alumnus, businessman and owner of BMW dealerships in Pretoria, Leo Haese sponsored UP's weekly lunch-hour concerts for 21 years.

the Convocation were approved by Council in November 2018, which were included in the revised Statute.

### Amendments to the UP Statute<sup>10</sup>

Between 2009 and 2018, a number of amendments were made to the University's Statute. In summary:

- The first set of amendments, in 2010/2011, were for reasons of good governance.

Council approved the proposed amendments at its meetings of 17 November 2010, and 16 March 2011 respectively. The latter amendments related to revisions to the constitution of TuksAlumni. The amendments to the UP Statute were submitted to the Minister of Higher Education and Training for approval, and published in *Government Gazette* No. 35195 of 30 March 2012.

- The second set of amendments, in 2016, related to the Convocation.

Council approved the amendment of paragraph 48(7) of Chapter 9 of the Statute relating to the election of Convocation members to serve on Council. The amendments were drafted against the background of an application to the Equality Court flowing from the previous elections in 2012/2013, and the finding that diversity must be achieved in the appointment or election of members of the Convocation to Council. The Minister approved the amendment, which was published in *Government Gazette* No. 40711 of 24 March 2017.

- The third set of amendments, also in 2016, related to the University's new language policy.

In concurrence with Senate, Council approved a new language policy for the University at its meeting of 22 June 2016. In order to give effect to the new language policy, the Minister was requested to approve the deletion of the details on the language policy provided in paragraph 3 of Chapter 2 in the 2012 UP Statute, to indicate that the language policy of the University shall be determined by Council with the concurrence of Senate, as provided for in section 27(2) of the 1997 Higher Education Act (Act No. 101 of 1997, as amended). The Minister approved the amendment, which was published in *Government Gazette* No. 41047 of 18 August 2017.

- Further amendments to the UP Statute were made in light of the Higher Education Amendment Act (Act No. 9 of 2016), which came into effect on 17 January 2017.

In addition to the amendments described above, it was considered necessary to do a full review of the University's Statute to align it with the Higher Education Act (as amended), as well as relevant guidelines, such as the *King IV Report on Corporate Governance for South Africa* (2016). The amendments were approved by Council at its meeting of 27 November 2017 and submitted to the DHET. Following a meeting with the DHET, a number of further amendments were made at the request of the Department. Council approved the further amendments to the Statute at its meeting of 27 June 2018. The amendments were subsequently approved by the Minister and published in *Government Gazette* No. 42127 of 21 December 2018.

<sup>10</sup> The text is adapted from a summary developed by Elzanie Slabbert, Head of the Secretariat.

## 3 | Senate

Senate oversees the University's academic activities and is the apex academic governance structure, in line with the Higher Education Act (Act No. 101 of 1997, as amended), and the UP Statute. Senate is accountable to Council for the way in which the University advances its academic mission. For this reason, regular summary reports and recommendations from Senate serve before Council for consideration. Full agendas and minutes of Senate meetings are available to Council members on request to the Registrar's office.

Chaired by the Vice-Chancellor and Principal, Senate comprises the Vice-Principals, the Registrar, Executive Directors, representatives of Council, Deans, Deputy Deans and academic staff with a similar status, Heads of Academic Departments and academic staff with a similar status, Chairs of Schools, Directors of service departments or divisions whose line function includes academic support, the Chair of the Institutional Forum, student representatives, and academic and non-academic employee representatives.

During the review period, Senate met twice per annum and, in addition, hosted a Senate conference at the beginning of the academic year. In line with Senate's role of providing academic leadership, the conference provides senators an opportunity to examine strategic, current and future-orientated issues which may affect the University and its development.

### Senate responsibilities

There is a clear delineation between the roles and responsibilities of Council and Senate, and that of Senate, the

Senate Executive (Senex) and the Senate Committees. Senate ensures that the University's academic offering is relevant, current and speaks to the needs of the broader South African society.

To fulfil its mandate, Senate must follow due process and consider the recommendations of the respective Faculty Boards and Senate Committees.

### Senate Committees

Senate is supported by the Senate Executive (Senex), Senate Committees and Faculty Boards. Following a review of committee structures and mandates in 2016, the respective terms of reference were redrafted and aligned with best practice. Each committee, chaired by a relevant member of the Executive, has a distinct mandate and reporting line to Senate. Senex considers all matters that need to be taken into account by Senate and makes recommendations to Senate. In addition to Senex, Senate Committees during the review period were:



Prof Antony Melck, Executive Director: Institutional Planning



Prof De la Rey and the Registrar, Prof Niek Grové

<b>Senate Committee for Research and Postgraduate Education</b>	The Committee guides the research strategy of the University and is responsible for the support and monitoring of all UP research and related activities.
<b>Senate Committee for Research Ethics and Integrity</b>	The Committee is responsible for a comprehensive policy on research ethics and integrity for the University, in accordance with the statutory requirements and best practices for research ethics and integrity.
<b>Senate Committee for Teaching and Learning</b>	The Committee is responsible for all matters pertaining to curriculum development and delivery.
<b>Senate Central Admissions Committee.</b>	The Committee oversees and coordinates undergraduate and postgraduate enrolment and monitors enrolment plans and admission policies.
<b>Senate Review Committee on Readmissions</b>	The Committee considers the possible readmission of students who have been excluded mainly because they failed to comply with institutional or faculty-specific regulations and requirements for progress. The Committee was reconstituted in 2013 to provide for effective student representation. In 2015, guidelines were updated.
<b>Senate Committee for Student Life and Student Services</b>	The Committee aims to ensure strategic alignment between faculties and support services with respect to holistic student life both in and outside the formal classroom environment.
<b>Academic Planning Committee</b>	The Committee provides an academic forum for discussion of key academic planning and development matters in order to provide the necessary background material for informed deliberation within Senex and Senate. It plays a key role in quality assurance, monitoring review schedules, self-evaluation reports, panel recommendations and improvement plans.
<b>Faculty Boards</b>	The Faculty Boards of the nine UP faculties and the Gordon Institute of Business Science (GIBS), are chaired by the Vice-Principal: Academic. They advise Senate on academic matters and are regulated by the Institutional Rules of the University.
<b>Senate Selection Committee for Honorary Degrees</b>	The Committee is responsible for considering proposals from the faculty executives regarding the conferral of honorary degrees, and considers candidates for the award of the Chancellor's Medal.
<b>Inter-Faculty Academic Committee — Mamelodi Campus</b>	The Committee is responsible for all academic matters of the UP Mamelodi Campus, and for cross-cutting coordination between UP faculties, activities on the Mamelodi Campus and the Mamelodi community.
<b>Senate Timetable Committee</b>	As indicated in the name, this Committee is responsible for the timetable of the University's academic programmes and activities.

### New and amended policies

By their very nature, institutional and academic policies are time- and context-appropriate and therefore need continually to be reviewed and updated. Academic policies are developed by stakeholder groups within the University and referred to faculty boards for discussion and feedback. They are then considered by the Academic Planning Committee (APC) and Senex before approval by the Senate.

Among the approximately 300 institutional policies, the list below shows some of the main policies approved by Senate in the review period.<sup>11</sup>

#### Some of the policies in this period

- Plagiarism prevention policy (2009) [S4726/09]
- Contract research and consulting policy (2010) [S4442/09]
- Intellectual property rights policy (2010) [Rt181/09]
- Education technology policy (2010) [S4485/11]
- Policy on joint degrees at master's and doctoral levels (2010) [S4444/11]
- Policy on teaching evaluation (2012) [S4451/13]
- Community engagement policy (2012) [S4559/12]
- Code of ethics for scholarly activities (2012) [S4755/12]
- Web policy (2014) [Rt291/14]
- Social media policy (2014) [Rt38/14]
- Policy on inaugural addresses (2015) [S4633/15]
- Integrated risk management policy (2015) [Rt40/15]
- Whistle-blowers policy (2015) [Rt377/15]
- Policy on teaching and learning (2016) [S4463/16]
- Policy on academic professional development: teaching and learning (2016) [S4671/16]
- Guidelines on curriculum design, development and implementation (2017) [S4691/17]
- Research data management policy (2017) [S4417/17]
- Revised regulation for honorary degrees (amended, 2017) [R27/17]
- Revised language policy (2017) [R31/16], [R56/17]
- Anti-discrimination policy and manual (2018) [R34/19].

<sup>11</sup> See <https://www.up.ac.za/article/2754069/up-policies-and-other-important-documents>

## 4 | Institutional Forum<sup>12</sup>

The Institutional Forum (IF) is constituted in terms of the Higher Education Act (Act No. 101 of 1997) and the Statute of the University. The IF is a representative advisory body, which advises Council on, inter alia, the implementation of the Higher Education Act and national policies on higher education; policy relating to racial and gender equity; selection of candidates for senior management positions; codes of conduct; mediation and dispute resolution procedures; policy for the promotion of a culture of tolerance and respect for fundamental human rights as well as a positive academic climate; and the management of diversity on the University campuses.

In the period under review, the IF comprised two representatives each of the Executive, Council and Senate; a representative from the ranks of each of the unions and employee organisations; one member nominated by TuksAlumni; one disabled person (either a staff member or a student) who is appointed by Council; ten members of the Student Representative Council who were appointed in accordance with the nomination procedure of the SRC; and one to two members elected within the discretion of the University Council on the basis of their expertise and experience, or to represent a stakeholder group that is not already represented on the Forum.

In 2009, three unions were represented on the IF, namely the University of Pretoria Workers' Organisation (UPWO), the University of Pretoria Staff Association (UPSA), and the National Education, Health and Allied Workers' Union (NEHAWU). From 2010, only UPWO and NEHAWU were represented and, in October 2018, the Academic and Professional Staff Association of the Universities of South Africa (APSA) took a seat on the IF.

Members representing a variety of expertise were appointed by the University Council to serve on the IF over the course of the review period. These included the Dean of Students,<sup>13</sup> Prof McGlory (MG) Speckman; staff members with disabilities, Simon (SW) Mahlangu and André (A) Kleynhans; and a member of Senate appointed for a second term, Prof Jean (JMS) Lubuma. In 2013, no-one was nominated to serve on the IF in the discretionary category. The list of IF members during the review period is given in Appendix F.

In terms of the Statute, the IF also elected an Executive Committee, which consisted of the Chairperson and Deputy Chairperson of the Forum and three other members, two of

which had to be students. While members of the Forum were duly elected to the IF Executive Committee every year, this Committee seldom met separately from the larger Forum.

Over the review period, an average of three or four ordinary meetings of the IF were scheduled to take place each year, with extraordinary meetings scheduled from time to time. Extraordinary meetings were mainly held to enable the IF to fulfil its statutory mandate to advise the University Council on candidates shortlisted for senior management positions. According to regulation, the Forum voted and did not discuss the candidates. The vote, which took place by way of a secret ballot, was a yeas or nays in respect of whether the candidate was 'suitable for appointment'. The University Council was not bound to accept the advice of the IF in respect of senior appointments. During this review period, members increasingly agitated for the opportunity to discuss candidates shortlisted for Executive positions rather than to merely vote on the suitability for appointment of the candidates.

At the ordinary meetings of the Forum, documents of a strategic nature and topics identified by the Forum were discussed. The documents on which the Forum advised included:

- The University's draft new strategic plan, UP 2025 (2011)
- Policy and Procedure for Staff with Disabilities (2012)
- Code of Conduct for Council Members (2013)
- Code of Conduct Applicable to Personal Relationships between Employees and Students (2014)
- UP Transformation Implementation Plan (2017)
- UP Language Policy (2017).

The topics and annual themes identified by the Forum were linked to its mandate, meaning that they generally had a transformation focus. For each topic, a convener was nominated from within the ranks of the Forum. The convener drew up a discussion document and one or more working group meetings were scheduled. Unfortunately, in most cases such working group meetings were poorly attended. The working group meetings were followed by a discussion by the Forum as a whole. Where appropriate, issues raised during these discussions were brought to the attention of the relevant line managers within the University or were forwarded to the Executive Committee or the University Council by the Chairperson. Some themes were addressed only by way of an information sharing session or presentation to the IF.

Examples of topics or themes identified by the Forum during the review period were:

- The University's language policy
- Creating a positive academic climate at the University
- Affordability, including food prices in residences
- International students (undergraduate and postgraduate) and general problems experienced
- Diversity and transformation, including progress made in respect of the UP Journey for Change<sup>14</sup>
- The implications of the *White Paper for Post-school Education and Training* (2013)
- Student and staff health and wellness, including the University's support to victims of gender-based violence
- In 2015, following several meetings on the topic, the IF prepared a proposal on appointing a University ombud for dealing with disputes. After extensive research and consideration, the proposal was, however, not implemented by the University
- In 2018, the IF had a discussion with the Vice-Principal: Student Affairs, the Dean of the Faculty of Veterinary Science and the Director and other staff members of the

Department of Residence Affairs and Accommodation to address concerns regarding transformation at the Onderstepoort Campus, in particular in as far as the residences were concerned.

In the broader South African university context, institutional forums remained a contested space, with these forums being dysfunctional, or worse, disruptive, at a number of universities. During 2008, the DHET commissioned The Growth Laboratory to conduct a national review of institutional forums. The report, which was completed in September 2008, was circulated to members of the University's IF. When the Higher Education Act (Act No. 101 of 1997) was subsequently amended, the IF was retained, and a requirement for Councils to provide written responses to advice received from the IF was included.

Within the UP IF, the role and mandate of the Forum was a perennial topic for discussion. As a rule, at the first meeting of the year, the IF considered its mandate as set out in the University Statute. In 2015, the Forum furthermore received feedback on a meeting held with IF chairpersons by the DHET, and the decision that a workshop would be held to consider the mandate of the IF and an appropriate agenda for discussion. However, due to the disruption caused by the #FeesMustFall campaign towards the end of the year, among other things, it was decided to postpone the workshop to 2016. At the workshop, which was held in April 2016, a representative of the DHET, Dr Philia (PR) Vukeya, addressed the meeting on the Department's expectations of institutional forums.

The sectoral focus on institutional forums was taken further in 2017 by Prof Yunus (Y) Ballim, who prepared a set of general guidelines for institutional forums and suggested the creation of a Community of Practice Forum of Institutional Forum Chairpersons. In 2018, the DHET hosted a further meeting with IF Chairs and Registrars on the role of the IF. Discussions at the UP IF focused on the Forum's role in respect of the cross-cutting issues of transformation, especially vis-a-vis the role of the Transformation Office and the Institutional Transformation Committee.

<sup>12</sup> Text prepared by Dr Desirée Tesner-Smith, Executive Operations Manager, UP Executive.

<sup>13</sup> This position changed to an executive portfolio with the appointment of Prof Themba Mosia as Vice-Principal: Students in 2013.

<sup>14</sup> See Section 7, Chapter 3.

## 5 | Student governance

The Student Representative Council (SRC) is the highest student governance structure and represents the students of UP in all aspects of student life. In accordance with the UP Statute, the SRC has formal representation on the University's Council, Senate, Senate committees, and the Institutional Forum. In the period between 2009 and 2018, Council considered and approved several amendments to the Constitution for Student Governance<sup>15</sup> and the appointment and composition of a Temporary Student Committee (TSC).

### Summary of elections

In September 2009, the SRC elections were disrupted by student political structures demanding that elections be run along party political lines rather than constituencies. The existing model provided for student representation from each of the nine faculties, with proportional representation based on the size of the faculty, as well as 20 members elected from the residences, day houses and service providers. The demand by student political structures resulted in a failure to constitute an SRC for 2010. A transitional year for student governance was 2010, with a temporary structure fulfilling the role of the SRC while a new constitution for student governance was negotiated. Once Council had approved the new constitution, a new SRC for 2011 could be elected. They took office in October 2010.

The new model for student governance provided for a two-tier constituency-based dispensation. The larger tier comprised the Student Assembly, with democratically elected members from whose ranks the smaller top tier of the SRC was elected. The constituencies consisted of the nine faculties, five student service providers<sup>16</sup> (later renamed key committees), residences, day houses and the Mamelodi Campus. In this model, portfolios were identified and allocated after the elections were concluded and the SRC was constituted.

Due to irregularities during the 2011 elections of the SRC for 2012, the election in seven of the constituencies was declared not free and fair, and a re-election had to be scheduled for early in 2012. Again, a TSC appointed by Council had to take charge of the day-to-day administration of student governance at the start of 2012 until a democratically elected SRC could take office. This SRC was involved in a further review of the constitution and the adoption of yet another model for student governance. This model provided for the election of 12 predetermined portfolios and seven ex officio members. Although student societies could no longer contest

in the elections, candidates, running as individuals, were permitted to declare their affiliations. The new model reduced the undue influence of external political parties in UP SRC elections and restored the focus on student leadership.

In spite of the extensive involvement of students in the development of the new model, controversies and objections still plagued the election processes in 2012. The elections for the 2013 SRC were suspended and a TSC had to be appointed yet again. Finally, the processes for electing the SRCs for 2014 and 2015 went smoothly, resulting in the constitution of a full SRC. The same was true for the SRC election for 2016, with the exception of the President and Deputy President. After due consideration, the University Council approved that the SRC could carry the two vacancies for the duration of their term, with an appropriate delegation of duties, as was required.

The election of the SRC for 2017 was scheduled for the period when the #FeesMustFall student protests had destabilised universities. No elections could be held and a TSC was appointed by Council. Fortunately, the next round of elections at the end of 2017, ensured the election of a full 19-member SRC for 2018. They served an extended term, commencing on 11 September 2017 until 31 December 2018.

One of the most significant achievements in student governance during this period was the switch to electronic voting. While the online voting system had been under development for several years, it was finally implemented with great success in 2017 and reflected increased voter participation.

Until 2012, all documentation for meetings of and with the SRC was made available in both English and Afrikaans. From 2013 onwards, English became the only medium of communication for the SRC.

Details of the membership and portfolios appear in Appendix G.



### Highlights of engagement

During their respective terms, the SRC or TSC made meaningful contributions to student life and the University. To illustrate, SRC/TSC input and recommendations on institutional policies and senior appointments were valuable, as was their input on the code of conduct for students. Other substantive matters on the agenda of the SRC between 2009 and 2018 included:

- The functioning of student structures such as day houses and societies.
- Residence matters, including placement, food, club houses and the need for additional and alternative student accommodation.
- Academic matters focused on the orientation of first-year students, internet access, plagiarism and exam fraud, extended library hours, the installation of clocks in exam and test venues and more.
- Campus-specific challenges facing students.

The SRC was involved in the preparation of the institutional culture survey of 2010/2011; student-led community engagement; the establishment of the Advisory Panel for Student Discipline (approved in 2012); the development of the University's long-term plan, UP 2025; the national Moral

Regeneration Movement; and naturally, in student protest action, #UPrising and the Fallist movement. The SRC was consulted on matters of transformation;<sup>17</sup> the move from Tukkiewerf and the Student Affairs Building;<sup>18</sup> annual student fee adjustments, payment schedules and financial aid;<sup>19</sup> and further student life issues, including student parking, inter-campus bus transport, student entrepreneurship, safety and security, religious practices in a secular environment, and the insourcing of contracted service staff, one of the consequences of the Fallist movement. The SRC, as the apex student governance structure, was also responsible for overseeing the student life<sup>20</sup> programme, including culture, sport and RAG. The programmes and activities underwent significant changes, driven by students.

The UP Executive maintained a practice of regular formal interaction with the SRC and other student structures, and the SRC was consulted on all salient matters pertaining to the student body. The Executive also ensured that members of the SRC received training and development opportunities to empower them for their role in student governance and beyond. In 2012, the University introduced formal mentorship programmes for members of the SRC, and since 2013, formal meetings chaired by the Vice-Principal: Student Life, Prof Mosia, took place, sometimes weekly. Important information was shared, key issues discussed, and a relationship of mutual trust fostered.

<sup>17</sup> SRC representatives were actively involved in transformation processes and platforms, including the Transformation Lekgotlas held in March and May 2016 and the workstreams flowing from these events.

<sup>18</sup> In 2009 staff of the Department of Student Affairs and student leaders were spread between the Student Affairs Building (the historical site of College residence), Tukkiewerf and the Student Health Services Clinic. The Department was relocated, with the management team and SRC being moved to Roosmaryn, the historic building that used to house Laerskool Pretoria-Oos, and other staff and structures moving to the properties around Roosmaryn.

<sup>19</sup> In 2012 the SRC established the SRC Aid Fund and approved that 0,5% of the SRC budget be contributed to the fund every year to assist destitute students with bridging funding for registration and textbooks at the beginning of each academic semester.

<sup>20</sup> The SRC was also a key participant in the Student Life Lekgotla held from 31 July to 1 August 2015, from which a new vision for student life was developed.

<sup>15</sup> The Constitution for Student Governance, which was approved in 2010, was replaced in June 2014 and amended in 2015 and 2018.

<sup>16</sup> Tuks RAG, Student Culture (STUKU), Student Sport Committee, *Perdeby* (later renamed PDBY) and Tuks FM.

## 6 | UP Executive and senior management

The University's Executive is responsible for strategic leadership and decision-making in the best interest of the institution. Their powers and duties are conferred by the University Council, the UP Statute and Institutional Rules. Portfolios are adjusted from time to time, at the discretion of the Vice-Chancellor and Principal, with the accompanying amendments to line responsibilities, where required.

The Vice-Principals, Executive Directors and Registrar are responsible for assisting the Vice-Chancellor and Principal in the strategic leadership, decision-making and operational management of the University. Given that executive and senior academic management positions are term appointments, it is to be expected that there would be a measure of flux. The period 2009 to 2018 saw several changes in the Executive team, portfolio allocation, the support team and in the senior management structure.

### The Vice-Chancellor and Principal

This volume in the *Ad Destinatum* series starts with the appointment of Prof Cheryl de la Rey in November 2009 as the 12th Vice-Chancellor and Principal of the University of Pretoria. She succeeded Prof Calie (CWI) Pistorius who had served in this leadership position from August 2001 to June 2009. Prof Chris (CR) de Beer, Senior Vice-Principal, served as Acting Vice-Chancellor and Principal for the period 1 July 2009 to 31 October 2009.

The Vice-Chancellor and Principal of the University is its chief executive and accounting officer, responsible for the management and administration of the institution. The appointment is for a five-year period, subject to possible renewal for a further term, at the discretion of Council. The Vice-Chancellor and Principal reports to Council and is supported by the senior leadership of the University — the Vice-Principals, Executive Directors and the Registrar.

Prof De la Rey was appointed for a second term in March 2014. In 2018, after nine years at the helm of UP, she resigned to take up a new role as Vice-Chancellor of New Zealand's University of Canterbury, from 1 January 2019. In November 2018, the Council approved the appointment of Prof Tawana (T) Kupe as Vice-Chancellor and Principal to succeed Prof De la Rey, with effect from 1 January 2019.



The appointment of Prof De la Rey marked an important point in the history of the University of Pretoria. She was both the first female and the first black Vice-Chancellor and Principal of the University. During her tenure, Prof De la Rey led the collective efforts to enhance the University's academic stature, improve its international rankings and attain its transformation goals. The University's long-term strategy, UP 2025, framed this era in the history of the University and shaped an identity that found expression as a research-intensive institution in Africa.

<sup>21</sup> At the time that Prof De la Rey assumed duties as Vice-Chancellor and Principal in November 2009, Mr Nel (Executive Director: Finance) resigned to pursue a career in the private sector.

### The Executive team

At the start of Prof De la Rey's tenure, the Executive team comprised of:

- Senior Vice-Principal Prof Chris (CR) de Beer; Vice-Principals Prof Ramaranka (RA) Mogotlane, Prof Robin (RM) Crewe and Prof Nthabiseng (NA) Ogude; Executive Directors Prof Antony (AP) Melck, Prof Antonie (AM) de Klerk and Johan (JS) Nel<sup>21</sup>; Advisor to the Principal, Prof Sibusiso (S) Vil-Nkomo; and the Registrar, Prof Niek (NJ) Grové.

In the years following the appointment of Prof De la Rey, changes took place in the composition and portfolio allocation of the Executive team. By the end of her tenure, in December 2018, the Executive team comprised of:

- Vice-Principals Prof Stephanie (SGB) Burton, Prof Norman (NTF) Duncan, Prof Themba (NT) Mosia and Prof Anton (A) Ströh; Executive Director, Prof Carolina (C) Koornhof; and the Registrar Prof Caroline (CMA) Nicholson.

As noted above, the Joint Committee of Council makes recommendations to Council with respect to appointment to executive portfolios. The list below provides a summary of the vacancies, appointments and reappointments during the period 2009 to 2018:

- In 2010, two Vice-Principal positions were advertised. In 2011, Prof Carolina Koornhof was appointed as Executive Director: Finance and Business Activities; and Prof Stephanie Burton as Vice-Principal: Research and Postgraduate Studies. Prof Antonie de Klerk was appointed for a second term as Executive Director: Infrastructure and Sport.
- In 2012, there were two vacancies in the Executive team and the Joint Committee met twice to consider the filling of these vacancies. Only one position was filled. Patience (TP) Mushungwa was appointed as Executive Director: Human Capital and Transformation.
- In 2013, the Joint Committee of Council met on three different occasions to consider the reappointment of Prof De la Rey for a second term; and the appointments of Prof Tyrone (TB) Pretorius as Vice-Principal: Academic, and Prof Themba Mosia as Vice-Principal: Student Affairs.
- The Committee met twice in 2014 to consider the appointment of Prof Norman Duncan as Vice-Principal: Academic and Prof Anton Ströh as Vice-Principal: Institutional Planning; and once in 2015, for the reappointment of Prof Burton and Prof Koornhof. No meetings were held in 2016.

- In 2017, the Committee approved the appointment of Prof Caroline Nicholson as Registrar with effect from January 2018.
- In 2018, the applications received for the position of a new Vice-Chancellor and Principal, as successor to Prof De la Rey, were considered.

A summary of the Executive team, their portfolios and the support staff in the respective offices is presented in [Appendix E](#). In addition to the core staff, several individuals were appointed for short periods to assist the Executive and the Vice-Chancellor and Principal with specific projects. These appointments are also summarised in Appendix E.

There are many areas in which the University of Pretoria, through its senior leaders and Executive team, contributed to strengthening institutional capacity, and to South Africa's development. Firstly, and as was to be expected, members of the Executive team contributed in many ways to strengthening the South African higher education system, linked to their specific fields of expertise. Over time, the University, through its Executive and the Registrar's Office, also provided critical input on draft policies and documents. In addition, members served in their individual capacity, or on behalf of the University, on various external structures, either linked to the higher education sector or more broadly within national, regional or international institutions. This brought visibility to the University and contributed to strengthening the University's academic identity as a university in and of Africa.

Secondly, and in recognition of the calibre of the senior UP leadership, there were also instances where individual members of the Executive team were seconded, at the behest of the Minister of Higher Education and Training, the DHET or the Presidency. In such periods, understandably, Executive portfolios needed to be adjusted. Two instances illustrate:

- In April 2011, Prof De Beer was seconded to the University of Zululand as the institution's full-time Administrator. The secondment was subsequently extended to October 2013, given the enormity of the task in rescuing the institution from a governance, systems and financial disaster. In 2014, the DHET requested a further secondment of Prof De Beer to work on a number of high-level projects, including the establishment of two new universities, and the interim principalship of the Sefako Makgatho Health Sciences University. In tandem, he continued to assist the UP Executive with internal UP projects until his retirement from the University in July 2014.



The Executive 2014-2017: Profs Niek Grové, Stephanie Burton, Antonie de Klerk, Temba Mosia, Cheryl de la Rey, Carolina Koornhof, Norman Duncan, Ms Patience Mushungu, Prof Anton Ströh

- In January 2016, Prof Mosia was seconded to the Presidential Commission of Inquiry into Higher Education and Training, a commission established by the then president of South Africa, Jacob Zuma, at the height of the #FeesMustFall student protests. The mandate included, among several higher education issues, to investigate the feasibility of fee-free education for poor and working-class students, and to make recommendations related to relevant funding model(s) for higher education. Led by Justice Jonathan (JA) Heher, the commission submitted its report to the president in August 2017. The report was released to the public on 17 November 2017.<sup>22</sup>

his retirement at the end of 2013, Prof Melck negotiated a donation of R50 million from the Javett Family Charitable Trust towards the establishment and construction of a new Javett-UP Art Centre, and R25 million operating capital for the first ten years, as well as a permanent loan of artworks estimated at R45 million, to assist the University in its mission of furthering the arts in South Africa. The construction of the Javett-UP Art Centre at UP on the University's South Campus in Hatfield commenced in 2016, with the Centre officially opened in September 2019. A gallery bridge spanning Lynnwood Road connects the Javett-UP with the Arts Square and student gallery at the south end of Tukkielaan on the Hatfield Campus.

### Operational governance

The UP Executive is supported by several committees which are summarised below. Deans and Directors make up the senior management of the institution and play a central role in the University's 'nested' approach to planning, and in strategic and operational management.<sup>23</sup>

In brief follows a summary of the structures that assist the Executive and the senior leadership in their institutional roles and responsibilities:

Counter to the recommendations of the Heher Commission, on 16 December 2017, the president announced that students from working-class and poor households would receive a full NSFAS bursary to cover the cost of their studies, as from the beginning of 2018.

A third area of exceptional contribution on the part of the UP Executive team related to fundraising, with many examples over this period that strengthened the University's third-stream income, infrastructure development, research and collaboration. One instance serves as an illustration: before

<sup>22</sup> The Presidency. August 2017. *Commission of Inquiry into Higher Education and Training*.

<sup>23</sup> See Chapters 4 and 5 for detail on faculties, academic and service departments, and research entities.

<b>Directors' Management Committee</b>	The Committee, chaired by Prof Koornhof (Executive Director: Finance), comprised the Directors of the support and professional departments. <sup>24</sup> With a schedule of fortnightly meetings, the primary purpose in the review period was to create a platform where cross-cutting professional service-related matters could be considered, for recommendation to the Executive and/or for implementation.
<b>Deans' Committee</b>	The Committee, chaired by Prof Duncan (Vice-Principal: Academic), and comprising Deans of faculties, provided a monthly platform to debate academic, operational and strategic matters. The Committee served as one of the conduits between the Executive and faculties, facilitating inter- and transdisciplinary initiatives and coordinating the submission of cross-cutting proposals to the Executive.
<b>Planning and Budget Committee<sup>25</sup></b>	The Committee, chaired by Prof Chris de Beer, was responsible for the integration of planning and resourcing and dates back to 2005. It was renamed the Resource Allocation Committee in 2009, and again renamed the Planning and Budget Committee in 2013. Prof Pretorius (Vice-Principal: Academic) chaired the Committee in 2013, and from 2014, Prof Ströh (Vice-Principal: Institutional Planning). The primary responsibility was to ensure that resourcing was sustainable and aligned with strategic priorities.
<b>Committee for Financial Aid and Bursaries</b>	The Committee was responsible for the development and implementation of financial aid policies, and advised the Executive on financial aid strategy.
<b>Institutional Transformation Committee</b>	The Committee championed diversity, equity and respect for human rights across the institution, and promoted inclusivity and a culture of dignity and rights.
<b>Operational Risk Management Committee</b>	The Committee was established in 2017, following campus closures during the student protests in 2015/2016. The role of the Committee, comprising members of the Executive and Directors in key departments, was to analyse, mitigate and manage operational risk arising from crisis incidents or disruptions, and to oversee the implementation of the University's business continuity plans.
<b>Strategic Risk Management Committee</b>	The Committee was responsible for assessing the impact and likelihood of strategic and operational risks of the University, against predetermined parameters. It recommends strategies and treatment plans to mitigate risks for approval by the Executive.
<b>Student Affairs and Residences and Accommodation Operations Management Committee</b>	The Committee was responsible for budget allocation and control of residence infrastructure, refurbishments and maintenance, food services, leased accommodation, the SRC and its sub-structure budgets, and operational units of the Department of Student Affairs (DSA).
<b>Facilities Advisory Committee</b>	The Committee was mandated to advise and make recommendations on matters within the scope of responsibilities of the Department of Facilities Management, and to act as the de facto tender committee of UP for projects that exceed the delegation of the Director: Facilities Management.

<sup>24</sup> See Chapter 5.

<sup>25</sup> The Planning and Budget Committee was replaced by the Strategic Planning and Allocation of Resources Committee (SPARC) in 2020.



## 7 | Office of the Registrar

There were two Registrars in this review period: Prof Grové served as Registrar for 18 years until 2017 when he returned to full-time academia in the Faculty of Law. Prof Caroline (CMA) Nicholson was his successor, appointed with effect from 1 January 2018.

The Registrar is the secretary of Council, the Standing Committee of Council, Senate and Senex. Accordingly, the Registrar must oversee the nomination and election of various categories of Council members, including employees, donors and members appointed on the basis of their expertise. The Registrar also oversees the election of members of Senate and the Institutional Forum. The duties of the Registrar are prescribed by the UP Statute and, from August 2013, include the role of the Deputy Information Officer of the University responsible for information governance.

In the review period, the Registrar's portfolio included oversight of Academic Administration and the Client Service Centre (which merged and became the Department of Enrolment and Student Administration (DESA)),<sup>26</sup> information governance, legal services, student discipline, UP Archives,

the Secretariat, the Hatfield City Improvement District (CID), as well as Security Services.<sup>27</sup> Three foci that formed part of the portfolio of the Registrar are singled out here for brief description: legal services, information governance, and UP Archives.

### Legal services

The Division of Legal Services at UP was headed by Elize (E) Gardiner and supported by Jacques (J) Ferreira and his team of CLS Consulting Services (Pty) Ltd (the company later changed its name to Inlexso (Pty) Ltd.). Ms Gardiner was supported by Jeanette (J) Kruger and, following Ms Kruger's resignation, by Ronél (R) Jordaan. In addition to the focus on student matters, the division also provided wide-ranging support to academic and professional/support services departments and staff.



Profs Grové and De la Rey with two previous UP Vice-Chancellors, Prof Johan van Zyl (l) and Prof Flip Smit (r)

<sup>26</sup> See Chapter 5.

<sup>27</sup> See Appendix E for further detail, and the department texts in Chapter 5.



l to r: Janine Esterhuizen, Elzanie Slabbert, Prof Niek Grové, Linda Pelser, Elana van Vreden and Shirley Motea

Mr Ferreira was supported by Ruaan (R) Pelser and Cyprian (C) Khumalo, with additional support from a 'back office' that consisted of experts in Labour Law, Environmental Law, Corporate and Commercial Law, Property Law, Governance and Compliance, etcetera. A number of graduate law students were offered internships on an annual basis to gain valuable experience.

In addition to the work of the Legal Services Division, the Department of Research and Innovation (reporting to the Vice-Principal: Research, Innovation and Postgraduate Education), attended to all research- and intellectual property-related legal work. Adv Lawrence (L) Baloyi headed this division. The Legal Collections Division in the Department of Finance attended to all student debt collection matters. Sarah-Lee (SL) Engelbrecht was the Head of this division and reported to the Deputy Director: Finance.

There were several matters that involved UP's Legal Services, for example:

- Amendments to the UP Statute and the University's new language policy, the latter resulting in court cases.
- The restructuring of the Convocation and Alumni entities, and the drafting of the institutional rules underpinning the Convocation structures and the proposed Alumni Advisory Board Constitution, subsequently approved by Council in November 2018.

- UP's registration as a credit provider in terms of the National Credit Act (Act No. 34 of 2005), in this period.
- A number of large-scale projects related to establishing inter- and transdisciplinary research platforms; e.g., the National Exotic Leather Cluster; TuksNovation NPC; the Sport, Exercise Medicine and Lifestyle Institute (SEMLI); and the development of Future Africa, Engineering 4.0 and the Javett-UP Arts Centre.

A number of sport-related developments in this review period, also involved Legal Services. These included:

- The incorporation of TS Soccer as a Campus company.
- The sponsorship of the Athletic Foundation Trust of the new high-performance school, the TuksSport High School, and bursaries for students.
- The legal contracts linked to the Varsity Cup competition.
- The agreement with Cricket South Africa for the construction of their high-performance centre on the Hillcrest Campus.
- The hosting of the Argentinian National Soccer team at the High Performance Centre (hpc) during the 2010 Soccer World Cup.

Related to staff and students, the #FeesMustFall and #InsourcingMustFall campaigns gave rise to numerous

court cases and disciplinary matters which involved Legal Services, and a new organised labour union, the Academic and Professional Staff Association of the Universities of South Africa (APSA), was recognised.

There was also a wide range of collaborative agreements, which included:

- The MOU with the City of Tshwane (CoT), and the conclusion of a land-swap agreement with respect to the Hammanskraal Campus and the Maritimo property.
- Negotiations undertaken with SANRAL related to the Gautrain development and the expropriation of property.
- The purchase of Erf 19 in Illovo, Johannesburg to expand the GIBS Campus, and the Nedhill property in Hillcrest to accommodate Enterprises University of Pretoria (Pty) Ltd. Varsity Lodge, Hatfield was also purchased as a student residence.
- Collaboration with the MasterCard Foundation resulted in a large number of student bursaries.
- The conclusion of a Tripartite Heritage Agreement between UP, SANParks and the South African Heritage Resources Agency (SAHRA).
- The conclusion of a bilateral agreement with the National Health Laboratory Service (NHLS) and an MOU with the South African Veterinary Council.

### Information governance<sup>28</sup>

In 2009, the need was identified for an institution-wide strategy for the management of institutional information. In a research-intensive institution, information (and data) are strategic resources. The complexity of institutional information in its many manifestations, combined with requirements regarding the protection and regulation of information, present governance, risk and compliance challenges. Following a workshop and a series of discussions, a proposal was submitted to the Executive for the development of a strategy and plan. One of the main recommendations was that there should be a broad-based information governance structure to direct and manage the various information-driven processes throughout the University.<sup>29</sup>

In 2010, an information management project was initiated at the University with the aim of taking forward the planned outcomes discussed in 2009. In 2011 and 2012, proposals concerning an overarching structure for the Quality Unit, a Unit for Information Governance, and an expanded version of the Language Unit (previously located in Academic Administration) were submitted to the Executive for consideration. While the specifics were not agreed to, the detailed work undertaken paved the way for informed decisions with respect to information governance, going forward.

At its meeting of 6 August 2013 (Rt 275/13), the Executive designated the Registrar as the Deputy Chief Information Officer of the University, responsible for the management of information as a strategic business asset, and for implementing an information management framework. Subsequently, in March 2014, the Vice-Chancellor and Principal approved the transfer of Janine (J) Esterhuizen (with post) from the Department of Human Resources to the Office of the Registrar to manage the information governance portfolio. On 16 May 2014, the Executive approved the Information and Data Governance Framework Policy, supported by an information governance matrix.

Initially the focus was on developing an institutional strategy for information governance and the required policies and procedures. The next step required a more collaborative approach to enable the coordination of related functions. With changes in legislation, internal structures and operational requirements, the initial information governance approach and policy had to be revised and aligned with the overall risk management and institutional compliance strategies identified. Following an information governance status report<sup>30</sup> to the Executive in November 2017, and the appointment of Prof Caroline Nicholson as Registrar on 1 January 2018, a project to develop a coordinated Information Governance and Privacy Protection (iGaPP) programme was approved by the Executive on 7 August 2018. Implementation of the iGaPP programme would roll out over a three-year period, starting in 2019.

The main driver for implementing the iGaPP programme was compliance with information-related legislation, including the Protection of Personal Information Act (POPIA) (Act No. 4 of 2013) and the European Union's General Data

Protection Regulation (GDPR). The iGaPP programme would bring together relevant policies, procedures, structures and controls to ensure that institutional information is managed in accordance with immediate and future regulatory, legal, risk and operational requirements.

### UP Archives

The period between 2009 and 2018 was one of growth and development for UP Archives in respect of staff, collections, facilities and activities. Following the consolidation of its position within the University in the previous review period, UP Archives was able to expand the scope of its collection, preservation and accessioning of records as well as its research support. It also saw an increase in use by UP staff and students in teaching and research, and by researchers external to the University.

Prof Karen (KL) Harris remained Director of UP Archives, a position which she had held since 1999. This was in addition to her position as full professor and later Head of the Department of Historical and Heritage Studies. Dr Ria (R) van der Merwe remained in the position of full-time assistant archivist, with the second assistant archivist position held by Bronwyn (BL) Strydom until the end of 2010. Ms Strydom was replaced by Alida (A) Green in 2011, first in a part-time capacity and since 2017, in a full-time position. UP Archives also employed administrative and student assistants in various capacities in part-time positions until the creation of two permanent full-time assistant archivist positions. From 2017, Sian (S) Pretorius and Tiffaney (T) da Gama were appointed, and a further administrative assistant, Coenie (C) Potgieter, was appointed from the end of 2015 until 2018. As a legally compliant institution within the University, UP Archives continued to report to the Registrar, Prof Grové, until 2017, and to Prof Nicholson from 2018.

### Archival space

Secure storage space for the growing archival collections remained a priority during this period. The ground floor of the southern wing of the Old Arts Building continued to be used as a reading room, office space and exhibition area for UP Archives.

From the end of 2017, the 'Century in the News' exhibition in Old Arts 1-20 was removed to make space for the temporary accommodation of the Javett-UP Art Centre offices. UP Archives still used the fifth level of the Humanities Building as an interim storage area and a portion of the Old Merensky basement for more frequently consulted records. During

2011 an air-conditioning system was installed in the area to dry out the air and maintain an ideal temperature for archival material.

A highlight of the period was the acquisition of much-needed additional space to accommodate some of the University's most critical collections with the refurbishment of the former SACTE (now Letlotlo) Building on the Groenkloof Campus. Space on the southern side of the third level of the building was reconfigured and equipped to house archival collections. Some of the large and critical collections of records were transferred into this space in 2015, including the University's Human Resources files.

### Projects and collaboration

Several annual projects continued from the previous era into the review years. These included the annual Q-Photo student photographic workshop competition, which expanded to include the collaboration of a photographic instructor from the VEGA educational institution in Pretoria. This collaboration continued until 2016, the last year of the project. At its close, the photographic project had run for a total of 15 years and had generated a unique collection of over 1 000 photographs for the UP Archives, depicting both the broader UP campus environment and student perspectives of campus life. Other projects which continued during this period were the Residence Archives and Photobook project, capturing and preserving the records of the various UP residences.

UP Archives also continued to play an active role in assisting the honours students in Heritage and Cultural Tourism who ran UP Campus Tours, with Dr Van der Merwe and Ms Green presenting hands-on sessions on doing research in archives. UP Archives further assisted with various UP Campus Tours projects, including the production of the award winning UP Campus Board Game and the presentation of the 'Walk back in time' campus tour, both in 2011. UP Archives collaborated with TuksAlumni in 2010, on a creative essay-writing competition, 'Fact-to-Fiction', that focused on Kya Rosa.

UP Archives maintained an ongoing involvement in various academic programmes at the University. Archival staff were involved in assisting with research assignments for undergraduate and honours students in History, Heritage and Cultural Tourism, and in Archaeology and Anthropology, and also contributed to the Engineering ENGAGE project. They also supported postgraduate students from a wide of range of disciplines with research for both master's and doctoral degrees. The collections of the Archives were used as part of teaching and student projects in a range of subjects and

<sup>28</sup> Adapted from a text developed by Janine Esterhuizen, Manager: Information Governance.

<sup>29</sup> The outlines of a proposed information management strategy, policy and structure to effect implementation were developed by Christa (C) North, Head of the Quality Unit at the time. The submission to the Executive (Rt 642/10) addressed aspects of the management of information, language and quality.

<sup>30</sup> Status Report on the Information Governance Portfolio. [Rt 681/17]

disciplines. Dr Van der Merwe continued to teach an archival component of the Postgraduate Diploma in Museum Sciences until the course offering was terminated in 2016.

UP Archives continued with its student trainee programme, a mentorship programme that involved the upskilling of postgraduate students on correct archival practices.

### Contributions to publications

The Archives assisted with research, information and visual material for a number of commemorative publications produced during this time for various departments and divisions at the University. These included the Graduate School of Management, Sonop Men's Residence, the centenary publications of the Faculty of Veterinary Science, and the Faculty of Theology and Religion, the 60th anniversary of the Faculty of Engineering, Built Environment and Information Technology, the 80th anniversary of *Perdeby*, TuksSport, the Department of Plant Physiology, and the Heidelberg Teaching College.

Assistance was also given on an ongoing basis to the Department of University Relations with information and images for articles published in *Tukkiewaria* and *Tukkie* and with the research, compilation and verification of information published in *Ad Destinatum V*.

In addition, the Archives assisted with research and visual material for a number of institutional celebratory events, publications and exhibitions, which included the *South Africa History Online* (SAHO) Women's Day exhibition (2009); the Old Arts Century photographic exhibition (2010); the 'Sport at UP' photographic exhibition (2013); 'A Century in the News' (2008–2017) exhibition; Kya Rosa and UP photo exhibition (2014); the 'Sustainability and UP' exhibition (2015); the 'Then and Now' exhibition (2016); 'UP's History through Photographs' (2008–2019) exhibition; the UP Choir, Tuks Camarata centenary publication and exhibition (2018–2019); *Humanities 100*, a centenary publication (2019).

### In support of research

UP Archives further assisted in facilitating research projects and continued to receive requests from the UP Executive, academic and administrative staff and students as well as alumni and external researchers. Another feature of this period was the large number of institutions, both higher education and corporate, that approached UP Archives for consultation regarding best practices in institutional archives.

In 2012, the UP Archives webpage was upgraded and expanded to showcase activities of the Archives, including some of its collections, workshops and photographic material that formed a part of its holding. From 2012 to 2014, the Archives selected and supplied photo galleries for the UPMobile marketing project.

The UP Archives remained involved with the [information governance project](#) (see above), which aligned well with the goals of the UP Archives in terms of the preservation of University records and their ultimate transfer to the Archives as the final custodian. In 2017, UP Archives staff attended training sessions on the Protection of Personal Information Act (Act No. 4 of 2013) and Prof Harris was nominated as Deputy Information Officer (POPI), while Dr Van der Merwe represented the UP Archives on UP's Information Governance Committee.

From 2016, Prof Harris and Dr Van der Merwe were involved with the Mellon Foundation Tangible Heritage Project in an advisory capacity. Prof Harris envisioned and developed a practical, hands-on, archival component for History honours students. The 'What's in the Box?' project was successfully launched in early 2019 using the Transvaal Education Department documents as a pilot project.

UP Archives embarked on projects during this period which highlighted the increasing role of technology and digital records within the University. In 2010 the Archives was part of the Systems Renewal Project which provided it with an electronic content management solution in the form of a database in which information items in a variety of formats could be captured, stored and retrieved. Furthermore, the digitisation of some of its key and most frequently used collections was earmarked as a long-term project that continues beyond the period of this review. A further focus during this period was to find solutions and methods to best preserve electronic records produced by the University, as many publications and records began to appear only in digital formats.

Despite the growing need to archive digital records, this period also saw the rapid expansion of physical records in the Archives. This included the preservation of the staff records collection, an important project that started in 2006 and involved the transfer, sorting and appraisal of over eight decades of staff records. This project was completed in April 2012.

### Research collections

Some of the larger research collections that were added to the Archives were the Art Archives collection and the Education Collection. The Art Archives is a collection of invaluable documents relating to South African art and artists collected since the 1940s by the Department of Visual Studies at UP. The collection is highly significant in terms of its heritage value and research potential and continues to be consulted both nationally and internationally. A further collection which was added to the Archives during this period, was the collection of the former Transvaal Education Department Museum which sheds light on developments in education in South Africa during the twentieth century.



Prof Caroline Nicholson, Registrar | 2018—

### A memory bank

UP Archives thus strengthened and furthered its mandate to act as the University's memory bank during this era, adapting and expanding to accommodate increasing demands for information and the need to house the institution's growing collections. However, the Archives continued not only to fulfil its legal requirements in terms of the retention of University records, but also to develop its role as part of the wider UP community, both in the services it rendered to other divisions within the institution and in the provision of teaching, learning and research support to UP students and staff, and national and international scholars and researchers.

# UP 2025 strategy



- 1. UP 2025, in a nutshell
- 2. Approach to planning
- 3. Enrolment planning
- 4. Teaching and learning
- 5. Research
- 6. Service, engagement and impact
- 7. Transformation

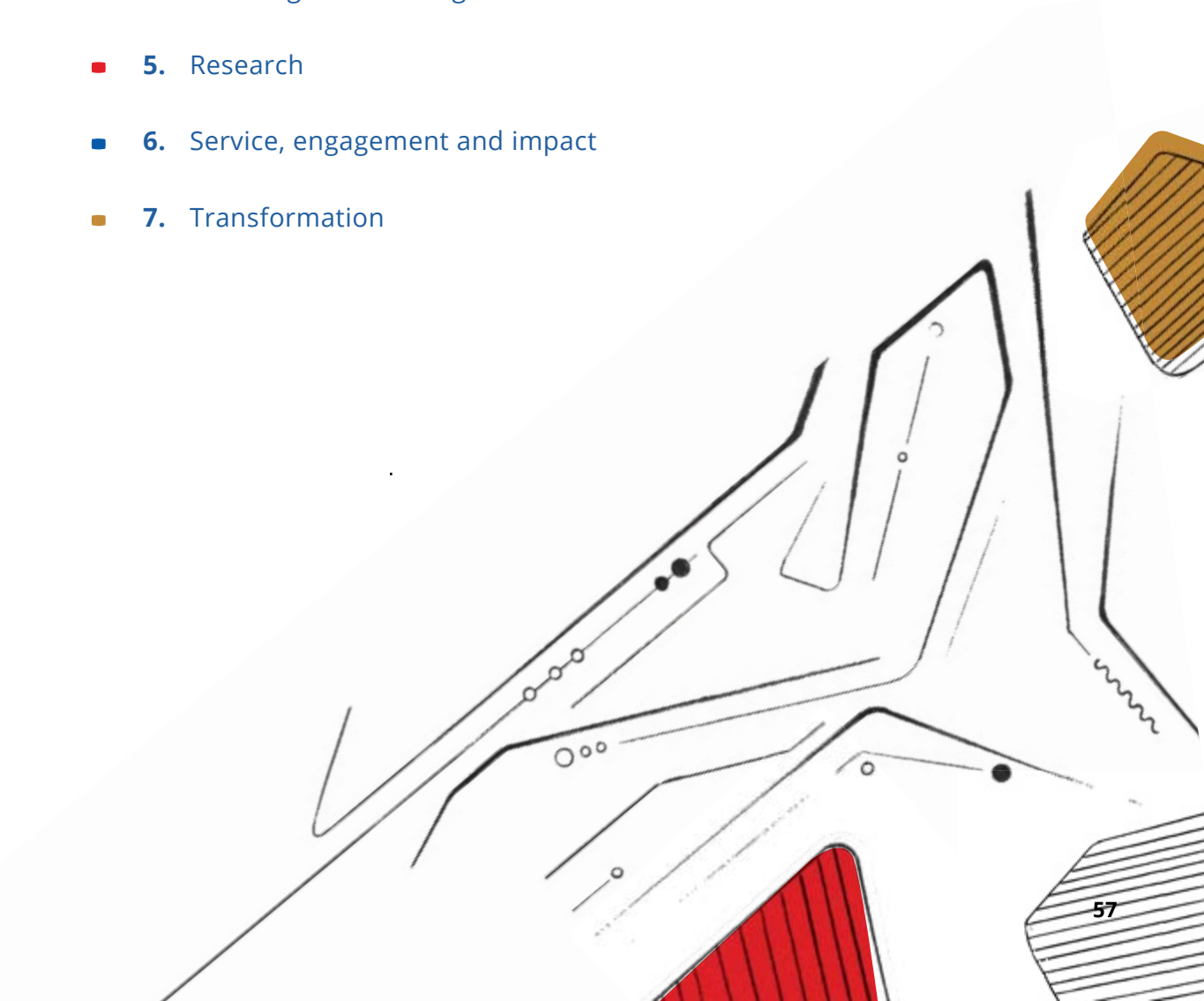

## 1 | UP 2025, in a nutshell

The University of Pretoria's long-term vision and strategy, UP 2025, initiated at the start of the leadership era of Prof Cheryl de la Rey as Vice-Chancellor and Principal, was informed by several investigations. It was formally adopted by Council in November 2011,<sup>1</sup> with 2012 marking the first year of implementation.

The focus of Chapter 3 is on the implementation of this strategy. UP 2025 set a clear and unambiguous pathway for the University's development, with the vision captured as follows:<sup>2</sup>

*To be a leading research-intensive university in Africa, recognised internationally for its quality, relevance and impact, and also for developing people, creating knowledge and making a difference locally and globally.*

Also significant were the 'navigational markers' — relevance, quality, diversity and sustainability — which became inscribed in the long-term strategy and the cycles of planning and implementation.

UP was deliberately positioned as a university that would pursue a research-intensive identity in South Africa's diverse and differentiated higher education landscape. As a large residential university with a comprehensive spread of academic offerings and research endeavour, this meant that choices needed to be made between competing priorities to ensure the successful implementation of the strategy.

From the onset, it was clear that a central challenge would be to focus research on local relevance and existing areas of capacity and strength, which were recognised on the international stage. Entailed, therefore, was the importance of developing a model for growth that would keep in balance the 'shape and size'<sup>3</sup> of the University.

In parallel, access remained a critical transformation imperative for the University and for the South African higher education sector. This has meant fair and equitable access that broadens participation and, at the same time, is aligned with national imperatives and the skills demands of the economy and South Africa as a developmental state.

In equal balance for UP was the ratio of undergraduate to postgraduate programmes, and of general-formative and professional programmes across levels of study.

Differential growth was also planned from the onset. The UP 2025 strategy describes in some detail what was meant by carefully planned and managed growth being at the heart of the University's long-term strategy:

*"The overall size of the University in the next 15 years will be determined to ensure that the University can realistically provide quality facilities to all its students and staff, and still have sufficient resources to be a research-intensive university".*

In addition, "managed growth needed to make provision for significant variation between and within faculties". At the time, it was planned that undergraduate numbers would grow by an average of 1,4% per annum until 2025, and contact postgraduates by 2,2%, which would result in approximately 55 000 students.<sup>4</sup>

A third area of the UP 2025 strategy was to build on areas of research strength in order to increase the University's research capacity and knowledge intensity, to have an impact, and to make a difference. This central refrain of making a difference was perhaps not new in the history of the University of Pretoria, but the ways in which this commitment was enacted most certainly were unique during this period in the history of the University. So, for example, the subsequent branding adopted by the University of 'make today matter' and doing 'research that matters' took on a specific commitment to having a positive impact on its immediate and broader communities and environments.<sup>5</sup>

<sup>1</sup> University of Pretoria. 2011. Strategic Plan: the vision, mission and plan of the University of Pretoria for 2025 (UP 2025). [Rt 673/11]

<sup>2</sup> UP 2025, pp. 3-5.

<sup>3</sup> 'Shape' is used in reference to the balance between general-formative and professional qualifications, and between different levels of study (i.e., undergraduate and postgraduate programmes), and scarce skills fields, whereas 'size' is in reference to enrolment numbers.

<sup>4</sup> UP 2025, p.13.

<sup>5</sup> UP 2025, pp.2, 4 & 6.

Further, the UP 2025 strategy was deliberately positioned in the contexts of the history of the University and the broader socio-political and economic environment, by:

- Recognising its early beginnings and strength in existing diversity
- Positioning its strategic trajectory within a changing socio-political, economic and higher education environment
- Declaring its vision, mission and values
- Foregrounding the core activities of research, teaching and learning
- Embedding community engagement and civic commitment in its academic mission
- Harnessing its strength as a large residential university to steer the research-intensive identity it wishes to attain
- Embracing diversity to enrich the University's intellectual environment and improve graduate outcomes
- Setting overarching goals, targets and key performance indicators.

The sections that follow elaborate on the major catalysts in the implementation of this strategy, and on progress achieved. In broad terms:

- Laying the groundwork for the University's long-term strategy
- An approach to planning, performance indicators and differentiation
- Enrolment planning in steering UP's shape and size
- Access with success, inquiry-led curricula and decolonising the curriculum
- Research relevance, internationalisation and an Africa strategy
- Contributing to social and economic development and foregrounding the public good of universities and the development of a critical citizenry
- Transformation — among others, a new language policy.

### Laying the groundwork

As noted in Chapter 1 and above, the period following Prof De la Rey's taking up office in November 2009 was in large part dedicated to engagement, discussions, analyses and foresight planning that resulted in the formulation and final approval in November 2011 of the University's long-term strategy, UP 2025.

Four task teams were appointed, in addition to the many parallel projects and discussions on the way forward for the University.<sup>6</sup> The task teams undertook, respectively, in-depth environmental scans of the socio-political, economic and education contexts in which the University was likely to operate in the medium and longer term, and a SWOT analysis of strengths, weaknesses, opportunities and threats. More specifically, the thematic foci were:

- The socio-political conditions in which the University operated and the likely impact of current and future trends on its role and identity.
- Prevailing economic factors, including the skills needs of the economy, and possible changes to the way public universities will be funded.
- Developments in the South African and international education sectors, and trends in modes of delivery flowing from advances in technology.
- The University's overarching strengths and weaknesses, and the opportunities and/or threats that should be harnessed, managed or guarded against.

The reports by the task teams were presented to the Executive and Deans for discussion in November 2010, and finalised for discussion at a Senate workshop held in January 2011. For the information and engagement of the broader University community, the reports were also placed on the UP Intranet, and a consolidated report developed on the outcomes of these think-tank groups, the latter including a timeline for the completion of the UP strategic framework and plan.

In broad overview, there were recurring themes foregrounded in these investigations.<sup>7</sup>



While it was unlikely that fundamental long-term strategies in research and education would change over a period of 15 years, it was inevitable that major external factors would impact on these strategies. The external factors were associated with globalisation, the impact of new technologies and environmental challenges. The findings of the environmental scans and analyses of global trends clearly indicated that in a shrinking world “the research we do and the way we teach” will increasingly be placed in the international spotlight; therefore the imperative for the University to grow its international strength and reach.

From this starting point, it was important to identify strengths and opportunities that would help to distinguish UP from other universities and would provide a unique advantage as a major research university in Africa and in the rest of the world.

Global trends and socio-political conditions pointed to the need for UP to become an engaged African university recognised for its contribution as a trend-shaper in Africa, the global South and the wider international community. The University was well-positioned to lead research on African issues and to provide education relevant to African needs. By responding to both these roles and imperatives, the University would strengthen its African identity. Embedded in the University's vision therefore needed to be recognition for UP's contributions and excellence in addressing some of the intractable problems of our times.

Also pointed out by the task teams, albeit in different forms, was that universities in the global South faced all the challenges encountered by their counterparts in the developed North, but that challenges were compounded by contexts where there were much higher levels of poverty and resource constraints, at a time when the generation of human capital was at a premium. Strategic choices would therefore need to be made, as the spheres of potential influence were many and multi-dimensional. However, it was also pointed out that futures are not inevitable. Whilst the aim of a developmental state and its institutions was, at least in theory, to emphasise social and economic inclusion, it would be difficult to predict what the relationship between the state, markets and society would be in 2025. In this regard, it was critical to recognise that universities have agency and the potential to impact on their immediate and broader environments.

Linked, therefore, was the understanding that universities, as one of the most enduring institutions in society, would be identified for the ways in which they respond to, engage with and manage the challenges of their contexts in an increasingly knowledge-driven world and economy.

The University's long-term strategy, UP 2025, was therefore designed to serve as a framework for the implementation of institutional priorities that meet the challenges of the contexts in which it operates, and to strengthen the quality of its research, education and outreach or societal engagement.

<sup>6</sup> See, for example, the study undertaken by Prof Christof Heyns and colleagues in 2010. Africa's Global University: Report to the Executive by the Task Team to Develop an Internationalisation Strategy (August 2010).

<sup>7</sup> Consolidated Report, January 2011, pp.28-32.

## 2 | Approach to planning

### A SUITE OF POLICIES

Following on the heels of the development and final approval of UP 2025, a new Academic Plan (2012)<sup>8</sup> and the first five-year implementation plan (2012–2016) were developed. Both were presented at a Senate Workshop in January 2012, held at the Gordon Institute for Business Science (GIBS). The first five-year plan was approved by Council at its meeting in March 2012.<sup>9</sup>

In essence, the University's 'nested' model of plan—act—review would allow for flexibility and the opportunity to realign strategy over one- and five-year planning horizons. This has meant that information needs to be gathered continually to monitor UP's actions and performance, and factors in the external environment that may have an impact on the strategy and trajectory of the University. Figure 3.1 depicts this nested model of planning.

In 2016, the second five-year plan (2017–2021)<sup>10</sup> was developed and, beyond this review period in 2021, a third and final five-year plan (2022–2026). Within the scope of

these five-year implementation plans, one-year institutional plans and budgets were developed. The iterative planning and realignment processes would ensure that UP remained responsive to contextual factors, and that faculty and support service plans were aligned in planning and review cycles with the institutional strategy.

The second five-year plan was particularly important as it was developed in the context and aftermath of the 2015/2016 #FeesMustFall student movement, and resulted in a refocusing and reformulation of the strategic goals the University had set itself.

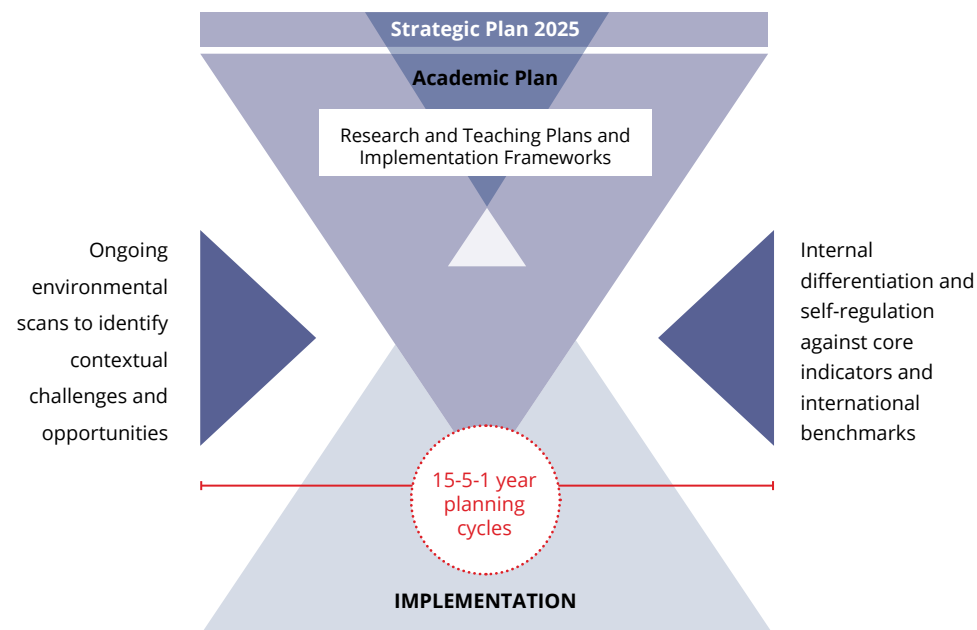

Figure 3.1. UP 2025 nested planning model

<sup>8</sup> University of Pretoria. 2012. Academic Plan, January 2012  
<sup>9</sup> University of Pretoria. 2011. Five-year Implementation Plan.  
<sup>10</sup> UP Strategic Plan (2017–2021).

UP 2025, 2012–2016	UP 2025, 2017–2021
To be a leading research-intensive university	To enhance access and successful student learning
To strengthen the University's international profile	To strengthen the University's research and international profile
To strengthen the University's impact on economic and social development	To foster and sustain a transformed, inclusive, and equitable University community
To pursue excellence in teaching and learning	To optimise resources and enhance institutional sustainability
To increase access, throughput and diversity	To strengthen the University's social responsiveness and impact on society

While the long-term vision of the University was retained, the sea change brought by student protests, nationally and at UP, called for a renewed focus on students to ensure that the University was sustainable and would thrive in a context of great instability and complexity.<sup>11</sup>

To illustrate:

- Students were positioned as the first priority and, in this sense, became an anchor strategy, together with fostering and sustaining a transformed, inclusive and equitable University community;
- Research and strengthening the University's international profile were combined into one goal;
- Social responsiveness and impact were constructed differently from the original focus on social and economic development; and
- Sustainability was foregrounded and linked to optimising resources; although sustainability is addressed in UP 2025,<sup>12</sup> it was not explicitly positioned as one of the five strategic goals until 2016.

In the context of disruption, sustainability became an overarching priority for the University and permeated "all aspects of UP's institutional life, inter alia, staff and students, resource utilisation, procurement, campus services, the built environment, energy and water utilisation, waste management and information and communication technology."<sup>13</sup>

<sup>11</sup> UP Institutional Plan and Budget. 2017, pp.3–4.

<sup>12</sup> See UP 2025, p.21.

<sup>13</sup> UP Institutional Plan and Budget. 2017, p.6.

<sup>14</sup> UP Institutional Plan and Budget. 2017, pp.3–4.

<sup>15</sup> UP Institutional Plan and Budget. 2017, p.4.

<sup>16</sup> The South Africa Higher Education Management Information System (HEMIS) is an electronic database maintained by the DHET. HEMIS data are audited and submitted to the DHET by individual institutions and include data on programmes and qualifications, student enrolment and graduation, staff employed, as well as financial data.

<sup>17</sup> See the summary of goals, strategies and performance indicators in UP 2025, p.11.

This disruption is vividly captured in the 2017 UP Plan:

"Academic programmes have been disrupted and many universities have been forced to close. This instability has significant implications for the sustainability of UP. [...] The immediate priority for UP is to ensure the successful completion of the 2016 academic year, and, for 2017, to ensure that the University is sustainable and thrives within the envisaged context of instability and complexity."<sup>14</sup>

The volatility of the 2015/2016 period also re-emphasised the importance of cycles of planning and review to allow for the realignment of institutional priorities. Key drivers in navigating the complexities of this changed landscape became "responsiveness and agility, entrepreneurship and innovation, partnerships and networks, harnessing the power of data analytics, and a dynamic institutional culture."<sup>15</sup>

### Evaluating performance

UP 2025 was developed in the context of the University's widely recognised history in monitoring performance over time, and its use of performance indicators and well-established metrics, HEMIS data,<sup>16</sup> other sources of information, and bibliometrics.

Thus, from the baseline year 2012, the goals, strategies and performance indicators articulated in UP 2025 could be used and refined to track progress, set targets and benchmark performance nationally and internationally.<sup>17</sup> Although the core indicators remained consistent, as is reflected in the performance reported on in this volume in the *Ad Destinatum* series, there were inevitable adjustments over the period, specifically in relation to one- and five-year plans.

As noted in a 2010 report on performance indicators:

“In principle, an institution’s goals and strategies can be viewed as a pyramid, the apex of which is formed by its vision and mission, and from which more detailed plans cascade down to lower levels. At the highest governance level, i.e. Council, the performance indicators must be comprehensive whilst avoiding detail, so as to provide an overview of the institution’s total performance.

Furthermore, performance indicators should be developed as a set because there are usually ‘trade-offs’ between an institution’s objectives, making it important to monitor the cross-cutting effects of attaining separate objectives on the other strategic goals.”

An institution’s basic set of indicators should remain relatively stable to allow trends to be identified. “Where a benchmark has not yet been reached, the trend may nevertheless indicate change in the right direction.”<sup>18</sup>

It was clear from the onset that a ‘one size fits all’ would be inappropriate for an institution such as the University of Pretoria, given its size and shape, and the large diversity in programmes and research endeavour. Internal differentiation would be an important mechanism in steering the trajectory the University wished to pursue.

### Performance indicators, benchmarks and targets

Performance indicators are statistical measures designed to provide empirical data on the degree to which an institution is achieving its goals. Performance indicators may be qualitative or quantitative and are often presented in the form of ratios that can be compared to internal targets to which the institution aspires, as well as to external benchmarks.

Benchmarks are norms or standards to which the performance indicators of an institution or university can be compared. They can be external to the university, for example comparable figures from a different higher education institution or an average for a group of universities; alternatively, they could be internal, for example the previous year’s values. Nowadays, benchmarking also refers to comparing processes to determine how the successes of other institutions can be ‘adopted’ and ‘imported’ into the home institution.

Targets indicate positions that an institution hopes to reach within a specific period of time and may be determined by referring to benchmarks.

Given its strong history of monitoring performance, the University of Pretoria was well-positioned to prepare its annual reporting and audited consolidated financial statements for submission to the Minister and Department of Higher Education and Training (DHET). As from 2013, these reports became a single integrated annual report, prepared in accordance with the Higher Education Act, 1997 (as amended).<sup>19</sup>

### Differentiation

Access and differentiation were concepts that had been under discussion for some time in the South African higher education sector, and were closely tied to the restructuring and transformation of the system. As captured in the 2013 *White Paper*, South Africa needed a university sector that was “purposefully differentiated”:

“Differentiation has long been debated in the higher education sector. There is broad agreement that South Africa needs a diverse university sector which is purposefully differentiated in order to meet a range of social, economic and educational requirements. Both *White Paper 3* and the National Plan for Higher Education recognise the importance of a diverse higher education system with different institutional missions and programmes. [...]

Differentiation is a way of ensuring a diverse system that will improve access for all South Africans to various forms of educational opportunities, improve participation and success rates in all higher education programmes, and enable all institutions to find niche areas that respond to various national development needs.”<sup>20</sup>

A basic premise has been that all universities must offer high-quality undergraduate education, and must have clearly defined mandates. It will be in the “mix and level of programmes” that institutions will be differentiated. Also specified in the 2013 *White Paper* was that the three institutional types will not change — traditional universities, comprehensive universities and universities of technology. In 2014, the DHET published a policy framework on differentiation that codified the extensive debate in the sector on differentiation and the steering mechanisms best suited to shaping a diverse and integrated system aligned to institutional mandates and the economic and development needs of South Africa.<sup>21</sup>

To return briefly to the 1997 *White Paper 3*, the focus in post-apartheid South Africa was on building a single coordinated

system, increasing access, and ensuring greater efficiencies and effectiveness. In the Foreword, the Minister of Education, Sibusiso (SME) Bengu, summed it up as follows:

“The *White Paper* outlines the framework for change, that is, the higher education system must be planned, governed and funded as a single national co-ordinated system. This will enable us to overcome the fragmentation, inequality and inefficiency which are the legacy of the past, and create a learning society which releases the creative and intellectual energies of all our people towards meeting the goals of reconstruction and development.”<sup>22</sup>

The National Plan for Higher Education (2001), in turn, foreshadowed the restructuring of the university sector that needed to address the problem of dysfunctional institutions and an inefficient system.<sup>23</sup> There were several analyses on differentiation that followed on the two *White Papers* of 1997 and 2013. The Council on Higher Education (CHE)<sup>24</sup> and the Centre for Higher Education Transformation (CHET)<sup>25</sup> spearheaded sector-level engagement over several years, aimed at refining the categories of institutions that made up the sector.

Badsha and Cloete (2011) comment, in a background paper developed for the National Planning Commission, that sector-level differentiation was not adequately addressed in the earlier post-apartheid years of policy formulation, given political contestation at the time. However, 15 years after the National Commission on Higher Education, at the first Higher Education Summit in 2010, a broad spectrum of the higher education community accepted differentiation as a strategy to bring greater diversity and “mission for purpose” into the system. There was also agreement that there should be a continuum of institutions differentiated in relation to their strengths and purposes, and linked to regional and local economic networks, and which facilitate the mobility of students, academics and knowledge across the sector. But, as

they observed, “of course, summit resolutions never resolve tough choices”.<sup>26</sup>

Nevertheless, differentiation evolved over time in the South African system, firstly based on institutional performance; and secondly, as a result of institutions both anticipating and responding to a fluid policy context. Key indices of performance have included the profile of students and staff, and output variables such as the level and number of graduates and an institution’s research output.

Three groups of institutions evolved that were characterised on a continuum of knowledge-intensity,<sup>27</sup> in broad terms corresponding to traditional universities, comprehensive universities and universities of technology. The University of Pretoria was grouped with the universities of Cape Town (UCT), Witwatersrand (Wits), Stellenbosch (SU) and KwaZulu-Natal (UKZN) as research-intensive universities, based on performance.

For UP, strengthening its identity as a knowledge and research-intensive university was critical in maintaining its position nationally, regionally and globally. In order to do so, the University used internal differentiation as a self-regulating mechanism to ensure that it would achieve the targets it set itself in UP 2025. Figure 3.2 illustrates one of the ways in which differentiation was depicted.<sup>28</sup>

A recurrent theme was that ‘good strategies emphasise difference’.<sup>29</sup> In the first instance, internal differentiation meant ‘smart growth’ and, through enrolment planning, to achieve an optimal balance between general-formative and professional qualifications, and between different levels of study. Secondly, internal differentiation meant different research output norms across disciplines and academic departments should be expected and needed to be agreed to in faculty and institutional planning processes. In this manner, it was anticipated that UP would manage its diverse mix of research and teaching programmes to ensure sustainability.

<sup>18</sup> See University of Pretoria. May 2010. Performance Indicators, p.2.

<sup>19</sup> Department of Education. 2007. Implementation Manual for Annual Reporting by Higher Education Institutions (2nd edition); followed in 2014 by Government Notice No R464, in Gazette No 37726 of 9 June 2014.

<sup>20</sup> DHET. 2013. *White Paper for post-school education and training: Building an expanded, effective and integrated post-school education and training system*.

<sup>21</sup> DHET. 2014. Policy framework on differentiation in the South African post-school system, July 2014.

<sup>22</sup> DoE. 1997. *White Paper 3. A programme for the transformation of higher education*.

<sup>23</sup> DoE. 2001. The National Plan for Higher Education. Pretoria. See also Jansen. 2001. Does the national plan effectively address the critical issues facing higher education? *SA Journal of Higher Education*, Vol 15(3), 5–9.

<sup>24</sup> CHE. 2000. Towards a new higher education landscape: meeting the equity, quality and social development imperatives of South Africa in the 21st century. Pretoria: CHE Shape and Size of Higher Education Task Team.

<sup>25</sup> See N Cloete. 2014. The South African higher education system: performance and policy. *Studies in Higher Education*, 39:8, 1355-1368, DOI: 10.1080/03075079.2014.949533

<sup>26</sup> N Badsha and N Cloete. 2011. ‘Higher Education: Contribution for the NPC’s National Development Plan’.

<sup>27</sup> N Cloete. 2014.

<sup>28</sup> Academic Plan. 2012, p.9.



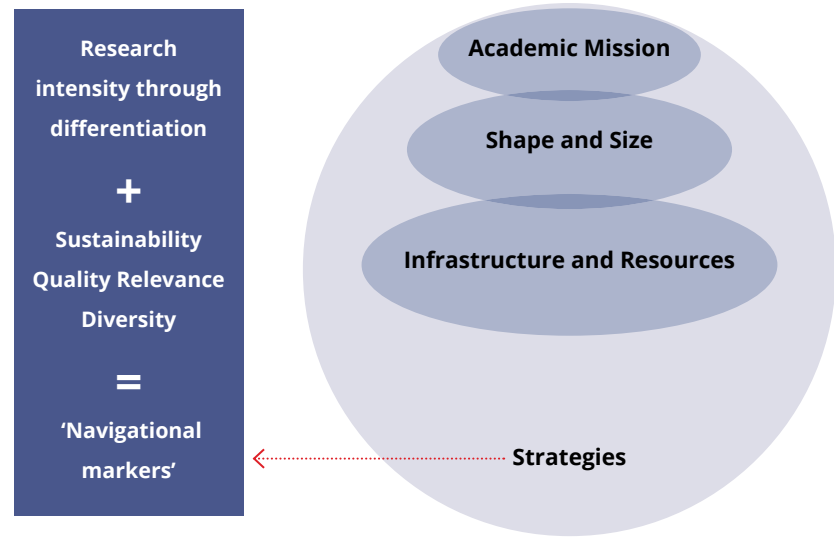

Academic and enrolment planning

Figure 3.2. UP 2025 internal differentiation

A third component in UP's differentiation strategy was to focus on consolidating areas of research strength for maximum impact and visibility, hence the focus on institutional research themes (IRTs) to increase capacity in areas of existing strength.<sup>30</sup>

By the time the Vice-Chancellor commissioned a study on how best to manage and sustain internal differentiation in 2012, the University of Pretoria had well-established categories of differentiation.<sup>31</sup>

<sup>29</sup> R Bradley et al. 2011. Have you tested your strategy lately? Constructing your 2011 Agenda. McKinsey & Company, pp.41 and 49.

<sup>30</sup> H Griesel. 2013. Differentiation at UP — a compilation of uses and ideas. University of Pretoria, February 2013.

<sup>31</sup> R Stumpf. 2013. University of Pretoria: Project on internal differentiation as a way of achieving the University's strategic goals for 2025. An implementation framework.



Credit: Marcholette Minnaar

### 3 | Enrolment planning

Enrolment planning has been central to the University of Pretoria’s annual planning processes. Firstly, the most visible contribution UP has made to the South African economy and society is in the number of graduates produced, not only in terms of the overall skills pool, but also in the urgent scarce skills areas identified by the DHET. Secondly, enrolment planning has been pivotal in steering the ‘shape and size’ of the University in alignment with its academic identity and the strategic goals it has set itself as a research-intensive university.

In essence, as mentioned earlier, ‘smart growth’ needed to ensure that an optimal balance was achieved between general-formative and professional programmes, and between different levels of study. Further, enrolment planning needed to be responsive to the national policy context, most directly, the 1997 and 2013 *White Papers*, and the 2011 *National Development Plan*,<sup>32</sup> tied to South Africa’s developmental needs.

At undergraduate levels in particular, equity and redress needed to be reflected in student profiles that were in balance with the demographics of South Africa, whilst growth in postgraduate enrolment also needed to strengthen the pipeline to research programmes and knowledge production and dissemination. In different terms, equitable access and increased participation — or access with success — remained high priorities for the University of Pretoria. At undergraduate levels, the challenge was to commit to quality teaching to safeguard the retention, success and graduation of students.

At the same time, maintaining the relationship between teaching and research was important not only to strengthen postgraduate studies, but also to embed the knowledge-intensive identity the University wished to pursue.

Over the 2009 to 2018 review period, UP developed four enrolment plans which, in agreement with the DHET, were finalised for implementation: the enrolment plans 2009 to 2011, 2011 to 2013, 2014 to 2019, and the mid-term enrolment plan, 2017 to 2019.<sup>33</sup>

UP 2025 set the long-term trajectory, linked to strategies and performance indicators, refined in subsequent planning cycles. The goals remained to pursue realistic growth in line with the academic vision; to steer the future shape of UP; to improve the ratio of postgraduate to undergraduate enrolments; and to improve the ratio of coursework to research postgraduate studies. The target was to reach enrolment of 55 000 contact and 20 000 distance students by

2025. The differentiated enrolment strategy is summarised on page 68.<sup>34</sup>

However, as has repeatedly been emphasised in the University’s annual reviews and enrolment plans, several factors impact on enrolment figures, hence the need continually to re-adjust targets. In addition — and although UP uses a robust set of goals, targets and performance indicators, and forecasts are derived from mathematical principles — several changes occurred in the higher education landscape and external environment during this review period that had an impact on enrolment.

Figure 3.3 summarises the headcount enrolment figures of undergraduate (UG) and postgraduate (PG) contact students for the period 2009 to 2018.

Table 3.1 (on page 70) shows the diversity profile of undergraduate and postgraduate students and in major fields of study in the review period, 2009 to 2018. The increase in international students over this period is summarised in Table 3.2, illustrating the contribution UP has made to the region, especially with respect to postgraduate education.

Figures 3.4 to 3.7 (on pages 70 and 71) show UP’s graduate output, both with respect to the number of undergraduate (UG) and postgraduate (PG) students; and the percentage black students.

Enrolment is closely tied to students’ success and several performance indicators were used to monitor achievement and to identify areas of risk in this review period. This aspect is reported on below, with further metrics provided in faculty profiles in Chapter 4.

FACULTY	FOCUS OF GROWTH	REASON
Engineering, Built Environment and Information Technology	Growth mainly in Engineering and PG levels	High-level skills and research intensity
Education: • Contact • Distance	Strong UG and PG growth Low growth	National need and relevance Revenue and demand
Economics and Management Sciences	Growth largely at PG levels	High-level skills and revenue
Health Sciences	UG growth and moderate at PG levels	High-level skills, national need and strengthen research intensity
Humanities	Low UG growth and emphasis on PG levels	Strengthen research intensity
Natural and Agricultural Sciences	Strong PG growth	Research emphasis
Law	Growth only at PG levels	Strengthen research intensity
Theology (and Religion)	Moderate UG and low PG growth	Currently, PG and research orientated
Veterinary Science	Medium UG and PG growth	National need and research intensity

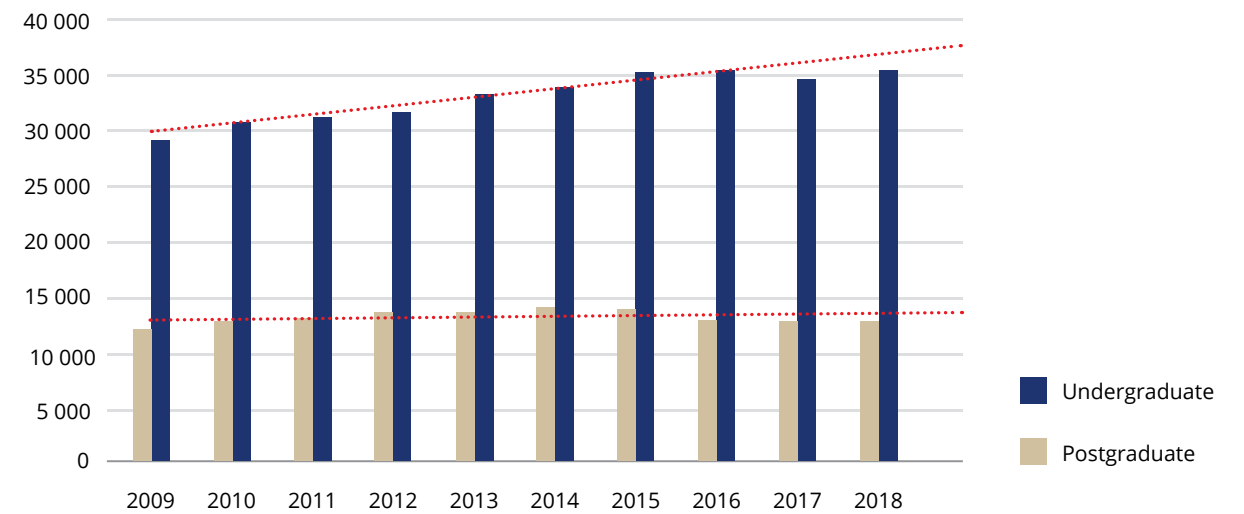

Figure 3.3. UG and PG headcount enrolment, contact students, 2009 to 2018

<sup>32</sup> National Planning Commission. 2013. National Development Plan — Vision for 2030. The Presidency.

<sup>33</sup> The text is adapted from these three-year rolling plans.

<sup>34</sup> UP 2025, pp.12–13.

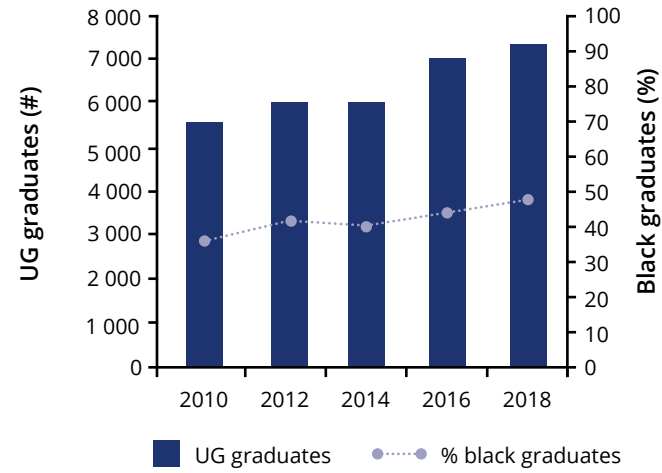

Figure 3.4. UG graduates and percentage black graduates, 2009 to 2018

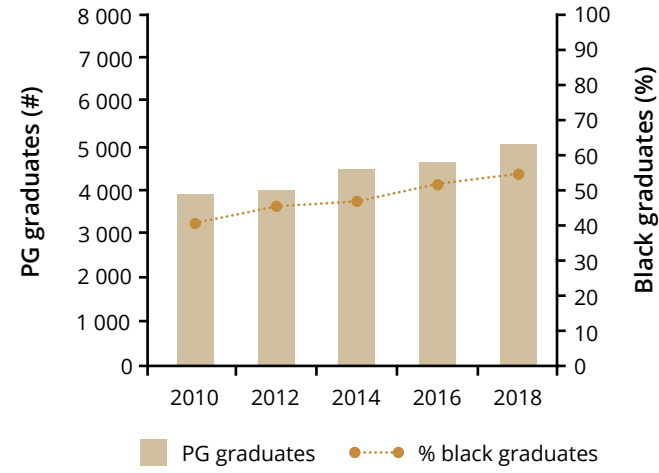

Figure 3.5. PG graduates and percentage black graduates, 2009 to 2018

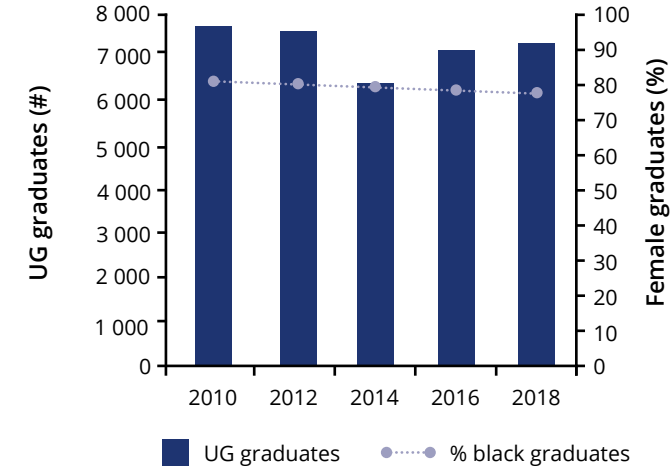

Figure 3.6. UG graduates and percentage female graduates, 2009 to 2018

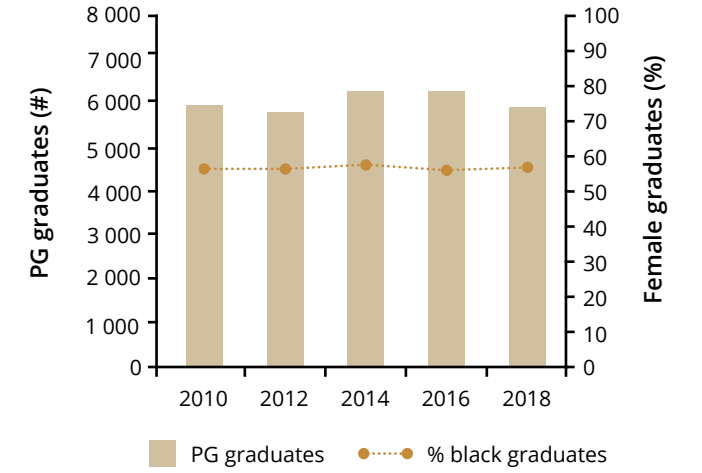

Figure 3.7. PG graduates and percentage female graduates, 2009 to 2018

Table 3.1. UP student diversity headcount enrolment, 2009 and 2018

Year	Level of study	Headcount student enrolments			Black students as % of headcount	Female students as % of headcount total
		Contact	Distance	Total		
2009	Undergraduate (UG)	29 211	6 998	36 662	52,3%	60,1%
2018		35 542	0	35 542	55,8%	56,6%
2009	Postgraduate (PG)	11 956	7 116	19 072	67,9%	55,7%
2018		12 536	1 916	14 452	66,0%	55,7%
2009	TOTALS	41 620	14 114	55 734	27 292	28 693
2018		48 515	1 916	50 431	28 106	27 099

Source: HEMIS, September 2020

Table 3.2. UP international student headcount enrolment, 2009 to 2018

	UNDERGRADUATE				POSTGRADUATE				Combined TOTAL
	SADC	Other African countries	Other countries	Total	SADC	Other African countries	Other countries	Total	
2009	1 165	180	282	1 627	720	393	268	1 381	3 008
2010	1 257	152	292	1 701	813	408	258	1 479	3 180
2011	1 492	176	423	2 091	1 011	468	328	1 807	3 898
2012	1 493	151	525	2 169	1 096	599	355	2 050	4 219
2013	1 560	153	540	2 253	1 175	659	372	2 206	4 459
2014	1 546	130	398	2 074	1 228	634	388	2 250	4 324
2015	1 534	137	352	2 023	1 207	654	414	2 275	4 298
2016	1 473	157	350	1 980	1 238	681	378	2 297	4 277
2017	1 306	130	294	1 730	1 245	661	372	2 278	4 008
2018	1 184	134	312	1 630	1 234	613	398	2 245	3 875



## 4 | Teaching and learning

### ACCESS WITH SUCCESS

UP 2025 describes teaching and learning as “key to fulfilling the primary function of the University; i.e. to producing knowledgeable and high-level skilled graduates in line with the needs of the South African economy and society, and to replenishing our own human capital needs and those of other knowledge institutions”.

This means:

- Developing an inquiry-led curriculum in building the foundation for knowledge, high-level skills and the pipeline of postgraduate students and researchers.
- Embedding a question-based approach in undergraduate teaching and using assessment as a tool for learning.
- Recognising the diversity of learning styles, experiences and histories represented within the student body, and responding in ways that creatively harness this variation.
- Providing multiple learning opportunities in a resource-rich environment in support of teaching and learning, and considering the most effective “blended” learning model to adopt.

- Focusing on the attributes desired in a research-led university that simultaneously develop skilled and compassionate students and graduates that can engage with developmental issues and compete in the global marketplace of the developed and developing world.

The crux of the University's teaching and learning strategy would be “to deliver independent learners who fit the profile of a research-intensive university, wherever their future career trajectories may lead — replenishing the human capital for the University, or as high-level skilled professionals entering the public or private sectors.”<sup>35</sup>

The Academic Plan (2012) elaborates on attributes, *what* is taught and *how*, and further, *who* the students are and the curriculum challenges associated with different learning histories and varying levels of preparedness:

“The first poses a unique opportunity to make explicit the epistemic assumptions about ways of knowing and knowledge production, while simultaneously taking cognisance of the history of ideas and formalised bodies of knowledge that constrain engagement in disciplines in particular ways. The second requires a deliberate layering of teaching, learning and assessment practices in order to allow students effective opportunities to engage in the form and content demands of disciplines.”<sup>36</sup>

Recognised in these planning frameworks was the dual challenge of diversity in learning histories, and the need to address the needs of intellectually talented learners who may in varying degree be underprepared for university studies.

Also important was the research undertaken that informed the policies developed in support of teaching and learning, which included:

- Policy on academic professional development: teaching and learning [2016, S4671/16 (amended), replacing S4490/10]
- Policy on teaching and learning [2016, S4463/16]
- Guidelines on curriculum design, development and implementation [2017, S4691/17]
- Policy on assessment [S4481/17].

### Recalibrating goals

While UP 2025 advocated a blended model for teaching and learning at the time, and the University increasingly adopted hybrid education as an enriched model of education, it would be the #FeesMustFall movement and student protests that propelled UP to go fully online with teaching, learning and assessment, particularly in 2016, in order not to forfeit the academic year. In addition to inquiry-led curricula, it also brought to the fore the idea embedded in UP 2025 of the need to develop a critical citizenry, especially in South Africa as a young democracy, which shifted to an emphasis on decolonising the curriculum.

One of the important outcomes of a lekgotla between student societies and UP leadership, held in March 2016, was that three workstreams were formed — on language, institutional culture and curriculum. Apart from the workstreams on

language and institutional culture (see Section 7 below), the work stream on curriculum transformation considered in detail what would constitute a transformed curriculum.<sup>37</sup> The framework document developed by this work stream was approved by Senate, first in September 2017, and the amended version in October 2018.<sup>38</sup>

The purpose of the document was to serve as a guideline for departments and faculties in the ongoing transformation of curricula; and the point of departure, “that every field of study holds implications that either advance or deter human and non-human life. Therefore, academic endeavour, prominently visible in curricula, must be in service of the public good and the actualisation of human potential”. The eloquently constructed document identified four drivers for curriculum transformation, each considered in some detail in this framework:

- Responsiveness to social context
- Epistemological diversity
- Renewal of pedagogy and classroom practices, and
- An institutional culture of openness and critical reflection.

For example, with respect to responsiveness to context, the following:

“A transforming curriculum is one that registers and is attuned to local and global contexts, histories, realities and problems. Such a curriculum promotes both a critical and self-critical stance. It acquires concreteness, relevance and purpose by being located within a specific social, economic, environmental, intellectual, political and legal context. Questions concerning development, social justice and globalisation, among other issues, should be central to teaching and research.” (2018, p.2)

Also stated is that the four drivers are intended to guide an inclusive process of engagement on what curriculum transformation entails in a societal context where exclusion, marginalisation and social injustice remain stark and are mirrored in higher education, and the particular histories of institutions such as the University of Pretoria.

The interlinked transformation imperatives included the demographic profile of students, institutional culture, governance and curricula.

<sup>35</sup> UP 2025, pp.9–10.

<sup>36</sup> Academic Plan. January 2012, p.15.

<sup>37</sup> University of Pretoria. 2022. Institutional Audit Self-evaluation Report, May 2022.

<sup>38</sup> University of Pretoria. 2017. Curriculum transformation framework: reimagining curricula for a just university in a vibrant democracy. [S4466/17 (amended)]

As noted earlier, the second five-year plan (2017–2021) focused on a reformulation of the strategic goals the University had set itself. While the long-term UP 2025 vision was retained, the sea change brought about by the Fallist movement, nationally and at UP, called for a renewed focus on students. “To enhance access and successful student learning” was positioned as the first strategic priority, tied to fostering and sustaining a transformed, inclusive and equitable university community.

### Student success

The University has, since 2009, developed an integrated approach to student success with a strong focus on the first-year experience through orientation (face-to-face and online), mentoring, advising and tutoring. The early identification of at-risk students remained central to student success efforts, therefore the importance of the Student Academic Readiness Survey (STARS) already administered during orientation. Students at risk are referred to Faculty Student Advisors (FSA) and the STARS mentorship programme.

In 2016, FLY@UP, ‘the finish line is yours’, was launched. It has been a multi-faceted campaign, led by the Department of Education Innovation, aimed at encouraging and supporting students to complete their studies in the minimum time.<sup>39</sup>

Table 3.3 gives an overview of the scope of undergraduate modules and of the aggregate pass rate, which increased from 79,3% in 2009 to 82,5% by 2018. This is also illustrated in Figure 3.8 (right).

This strong performance is particularly noteworthy in relation to the increase in student to staff ratios over this period, from 16,9 full-time equivalent (FTE) students<sup>40</sup> to staff in 2009 to 25,4 in 2018.

Teaching and learning are closely linked to research, as captured in UP’s 2016 policy on teaching and learning:

“Scholarly teaching draws no hard distinction between research and teaching, recognising that the best teaching draws on, and is informed by, the newest developments in research. At the same time, scholarly teaching and the scholarship of teaching and learning, at their best, extend and enrich knowledge, thereby raising new questions for advanced inquiry. In this way, a symbiosis between teaching and research is maintained.”<sup>41</sup>

In the same vein, UP has pursued a strong trajectory of evidence-based decision-making about students’ progress. Also in 2016, the Vice-Principal: Academic established an analytics team, Tshebi,<sup>42</sup> to monitor undergraduate student success. Faculty representatives include deputy deans of teaching and learning, and the departments of Education Innovation, Information and Technology Services, Enrolment and Student Administration, and Institutional Planning. The focus, in large part, has been on the use of the Higher Education Data Analyser (HEDA) data system and dashboard, developed by Institutional Planning and which is available to all faculties. Of particular relevance is student success, including throughput and graduation, and understanding student engagement as a factor in stemming high drop-out rates.<sup>43</sup>

The retention of students and their successful completion of studies is an issue that is closely monitored at UP. Table 3.4 (page 76) gives, in overview, comparative data on the overall percentage of modules passed in relation to registrations, the exam pass percentage, and importantly, the drop-out percentage over the period 2012 to 2018.

Table 3.5 (page 76), in turn, provides a detailed breakdown of throughput with respect to graduates over the period, 2009 to 2018. Contact mode graduates increased from 9 247 in 2009 to 12 681 graduates in 2018, while the overall graduate output increased by a few hundred from 12 922 to 13 273, mainly as a result of the phasing out of the distance programme leading to the Advanced Certificate in Education (ACE) offered by the Faculty of Education.

Table 3.3. FTE undergraduate module pass rates, 2009 to 2018

CONTACT FTE	Passed UG FTEs	Total UG FTEs	Modules pass percentage
2009	24 058,9	30 338,8	79,3%
2010	24 657,9	30 786,0	80,1%
2011	21 868,1	27 172,8	80,5%
2012	22 227,9	27 274,1	81,5%
2013	23 602,2	29 066,0	81,2%
2014	24 490,9	29 704,3	82,4%
2015	25 074,1	30 432,5	82,4%
2016	25 514,0	30 460,4	83,8%
2017	23 819,2	29 101,2	81,8%
2018	24 062,3	29 163,6	82,5%

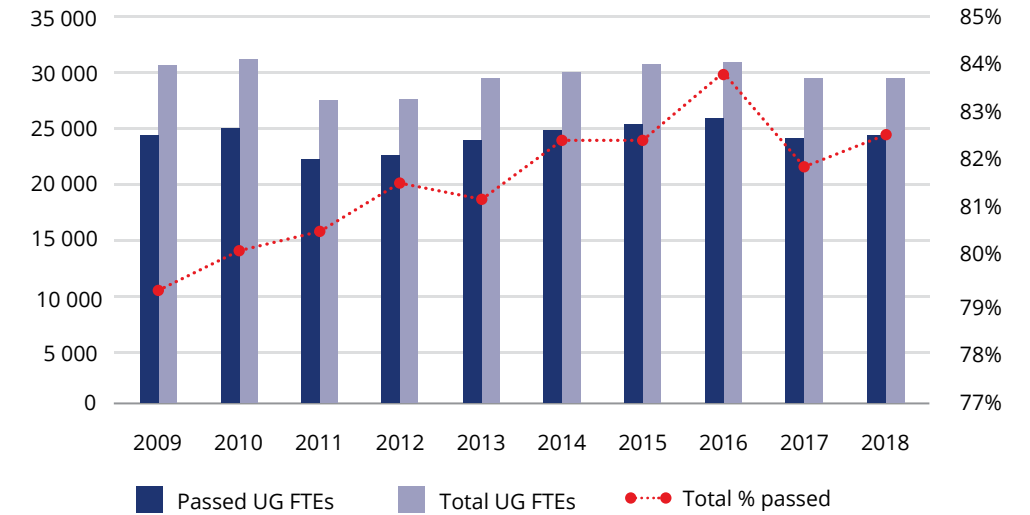

Figure 3.8. FTE undergraduate module pass rates, 2009 to 2018

<sup>39</sup> UP Annual Report. June 2018, pp.42–43.

<sup>40</sup> Full-time equivalent (FTE) student enrolments are calculated by assigning to each course a fraction representing the weighting it has in the curriculum of a qualification, and by multiplying the headcount enrolment of that course by this fraction. See DHET. 2019. Statistics on Post-School Education and Training in South Africa.

<sup>41</sup> University of Pretoria. 2016. Policy on Teaching and Learning. [S4463/16]

<sup>42</sup> Tshebi means the data-driven approach to monitoring student success which was spearheaded by the Department of Education Innovation.

<sup>43</sup> UP Department of Education Innovation. 2018. Annual Report.

Table 3.4. Average undergraduate module pass rates for contact students, 2012 to 2018

	Term	Number of modules	MPP %	EPP %	DP %	AP %
Totals	2012	2 386	80,34%	88,79%	7,15%	2,46%
	2013	2 304	80,31%	89,05%	7,94%	1,95%
	2014	2 127	81,79%	90,24%	7,68%	1,75%
	2015	2 089	81,61%	90,26%	8,17%	1,48%
	2016	2 105	83,18%	89,74%	5,38%	1,99%
	2017	2 148	81,60%	90,60%	8,50%	1,40%
	2018	2 129	82,60%	90,50%	7,40%	1,40%

**KEY**

MPP = Module pass percentage: Proportion of students who passed the examination in relation to the total number of initial registrations expressed as a percentage.

EPP = Examination pass percentage: Proportion of students who passed the examination in relation to the number of students who wrote the examination, expressed as a percentage.

DP = Drop-out percentage: Proportion of students who dropped out (cancellations PLUS exclusions) in relation to the total number of student registrations, expressed as a percentage.

AP = Absenteeism percentage: Proportion of students who were absent from the examination in relation to the number of students admitted to the examination, expressed as a percentage.

Table 3.5. UP contact and distance mode graduates, 2009 to 2018

	CONTACT MODE						DISTANCE MODE				OVERALL TOTAL
	PhD	Master's	Honours	PG other	UG	TOTAL	Honours	PG (other)	UG	TOTAL	
2009	196	1 154	2 083	365	5 449	9 247	1 249	6	2 420	3 675	12 922
2010	188	1 267	2 256	437	5 531	9 679	1 825	0	2 196	4 021	13 700
2011	206	1 342	2 171	420	5 976	10 115	1 476	6	1 876	3 358	13 473
2012	200	1 400	2 226	408	5 976	10 210	1 562	3	1 633	3 198	13 408
2013	242	1 476	2 290	491	6 477	10 976	1 753	8	1 435	3 196	14 172
2014	237	1 621	2 371	525	5 972	10 726	1 539	3	454	1 996	12 722
2015	333	1 897	2 395	508	6 501	11 634	1 623	2	182	1 807	13 441
2016	302	1 811	2 282	532	7 030	11 957	1 373	0	169	1 542	13 499
2017	354	1 866	2 034	834	7 058	12 146	1 124	0	3	1 127	13 273
2018	424	1 993	2 098	828	7 338	12 681	611	0	0	611	13 292

Of particular relevance for the University's research-intensive strategy, is the steady increase in the number of doctoral and master's students over this period.

## 5 | Research

### A RESEARCH-INTENSIVE IDENTITY

At the heart of the University's research strategy, and UP 2025, remained the commitment to pursue research related to problems and issues of contextual relevance — be it at local and national levels, or regionally and globally. In the implementation of the University's long-term strategy, the mantra became 'doing research that matters'; phrased differently, research that engages complex and urgent societal challenges. These included, as extrapolated in 2018, the environment, climate change, food security, poverty alleviation, health, education, and evidence-based policies for development, among others.

The focus on relevance was expressed in UP 2025, as a dual focus on increasing international visibility and research capacity "in areas of importance to developing nations, especially those of Africa and in the global South."<sup>44</sup> A central challenge was to strengthen UP's position as a research- and knowledge-intensive university, and on ways in which to attain the University's ambitious targets over the medium to longer term. In order to maximise the international and national impact of research, a theme-based approach was adopted in which resources were concentrated, in the first instance, in a select number of Institutional Research Themes (IRTs), and in some instances, Faculty Research Themes (FRTs). This enabled a critical mass of researchers in areas of institutional strength, and, as a result, increased research capacity and output.

Research relevance also became closely associated with frameworks for development, with the University's commitment to generating knowledge increasingly framed — in direct and indirect ways — by the UN Sustainable Development Goals (SDGs), the African Union's *Agenda 2063*, and *South Africa's National Development Plan*. So, for example, in reporting on progress achieved in 2018, it was reiterated that the University's research strategy focused on increasing productivity and achieving higher impact, and on "research that is both contextually relevant and speaks to major challenges globally, and in particular in Africa as a developing region".<sup>45</sup>

#### Research productivity<sup>46</sup>

There were several indices that show UP's strengthened research identity, with core performance indicators (PIs) including the percentage of staff with PhDs, research

output and the total weighted research output per full-time equivalent (FTE) academic staff, and the number of master's (M) and doctoral (D) students.

Table 3.6 (page 78) provides a summary of the indicators used over time that shows that in all areas there had been a strengthening in research capacity and productivity from 2012, the start of the implementation of UP 2025, to 2018.

The DHET report on sector-level research performance<sup>47</sup> shows that UP achieved, with the University of KwaZulu-Natal, the highest percentage (10,8%) of the total research output units of South African universities for 2018, and the highest weighted output per capita in the sector at 3,70. This performance was constant over the period 2009 to 2018, with UP achieving the highest outcomes, or placed among the top performing universities in the sector.

Table 3.7 (page 79) shows the overall research output units per publication type.

While there was a steady increase in the overall research output between 2012 and 2016, the slight tapering off in 2017 and 2018 could have been the result of a combination of factors; for example, new cohorts of young academics who were still to become productive researchers.

Figure 3.9 (page 79) shows a comparison of weighted research output between five research-intensive universities in South Africa for the period 2009 to 2018, illustrating the strong relative position of the University of Pretoria.

UP's performance with respect to normalised publication output shows that, in 2018, it achieved the highest among comparator universities in:

<sup>44</sup> UP 2025, p.8.

<sup>45</sup> University of Pretoria. June 2019. Annual Report, p.45.

<sup>46</sup> The text here is adapted from the UP Annual Reports, 2018 and 2019.

<sup>47</sup> DHET, 2020. Report on the Evaluation of the 2018 Universities' Research Output.



Prof Tjaart Kruger (Department of Physics), with MSc student Asmita Singh (l) and PhD student Alexander Paradzah (r)

Table 3.6. Key areas of research capacity and performance, 2012 and 2017-2018

Indicators	2012	2018
Staff with PhDs	43,03%	69,6%
NRF-rated academic staff	433	507
Accredited publication units per academic FTE staff	0,7	1,11
Weighted M and D output per academic FTE staff	0,68	1,56
M graduates	1 400	1 993
D graduates	200	427
PhD students enrolled	1 860	2 307
M students enrolled	6 559	6 116
Diversity profile: % black PG students	53%	62%
Postdoctoral fellows	109	253
International postdoctoral fellows	78	164
International academic staff	62	180

Source: DRI and HEMIS, Annual Report 2019: 46; DHET 2020.

Table 3.7. UP research output units per publication type, 2012 to 2018

	Journal articles	Book publications	Proceedings	TOTAL
2012	1 279,12	159,62	154,33	1 593,07
2013	1 407,07	70,36	136,84	1 614,27
2014	1 470,05	123,47	155,00	1 748,52
2015	1 583,44	153,76	177,81	1 915,01
2016	1 714,97	251,92	159,16	2 126,05
2017	1 721,12	210,46	118,02	2 049,60
2018	1 702,54	266,80	85,20	2 057,05

Source: DRI, June 2022; and 2018 data, DHET, 2020.

Table 3.8. UP's comparative position in relation to per capita publication outputs, 2018

Category	Per capita publication output	Weighted per capita publication output	Academic staff with PhDs (%)
UP	1,71	3,70	69,6
UKZN	1,54	3,33	55,6
UCT	1,51	2,56	64,0
SU	1,64	3,19	57,2
WITS	1,59	3,03	65,9
Sector average	0,97	1,91	48,0

Source: DHET 2020.

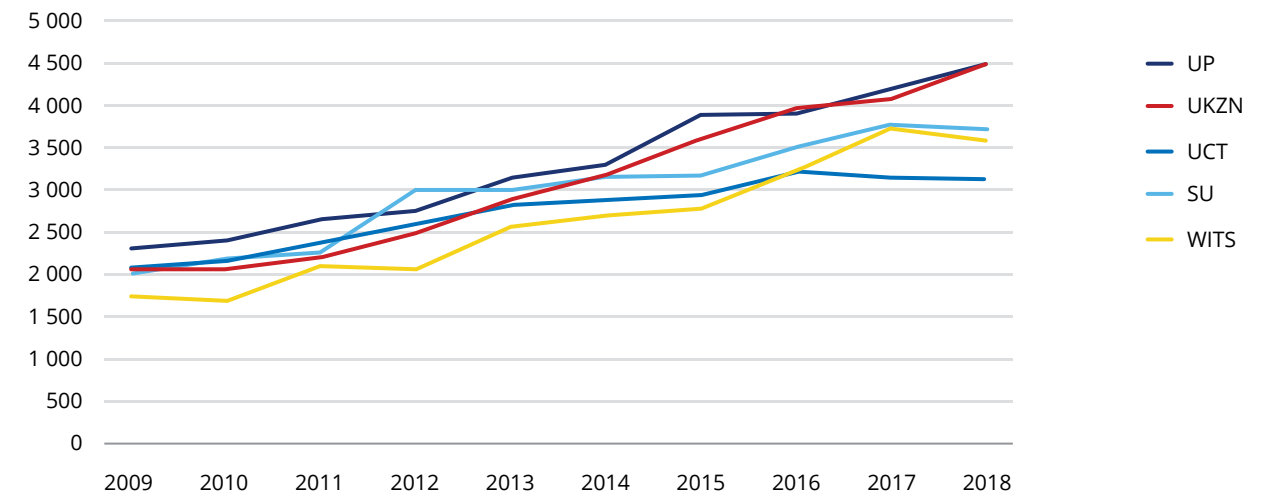

Figure 3.9. UP's comparative position in weighted research output, 2009 to 2018

- Per capita research publication output (1,71) — i.e., the total number of publications divided by headcount academic staff.
- Weighted per capita research output (3,70) — i.e., total number of publications plus master's and doctoral graduates divided by the headcount academic staff.
- The proportion of academic staff with doctoral degrees (69,6%).

The comparison of five research-intensive universities is shown in Figure 3.9.

### Internationalisation, visibility and impact

Internationalisation has been closely associated with the University's research strategy and the focus on impact and visibility. As noted earlier, two of the five overarching strategic goals in UP 2025 were linked to research and internationalisation:

- to be a leading research-intensive university; and
- to strengthen the University's international profile.<sup>48</sup>

In the second five-year plan, UP 2017–2021, the two goals were combined into one: to strengthen the University's research and international profile.<sup>49</sup>

An important element to the University's international profile is the visibility of the institution, its researchers, and the research published. With respect to research, visibility relates to citations, impact and world rankings. In the second five-year plan (2017–2021), the context in which the University

operated was depicted as one of competition and adaptive strategies:

"The competition for talented researchers is driven mainly by the pursuit of research excellence and reputational capital by universities. [...] The intense competition among universities has fuelled a number of adaptive trends such as partnerships, differentiation, specialisation in areas of research where there is demonstrated strength, re-inventing the student experience, online delivery and internationalisation."

In all of these adaptive strategies, the University has been proactive, and several measures were used in this period to monitor international activity, such as the number of active agreements with international organisations and institutions. In 2018, the total number of active agreements with international partners stood at 202, which reached across 70 countries and six continents.

One of the most stable indicators of the extent of internationalisation is the number of co-authored papers published with researchers globally. This measure serves as a proxy for the effectiveness of partnerships and international networks of collaboration, especially linked with field-normalised citations which can be used as a measure of impact and visibility — see Figures 3.11, 3.12.

Figure 3.10 below shows the percentage increase in co-authored papers between 2009 and 2018, an increase from 35,6% to 46,9%. The field-weighted citation impact (FWCI) shows that UP consistently performed above the global norm of 1,00 as shown in Figure 3.11.

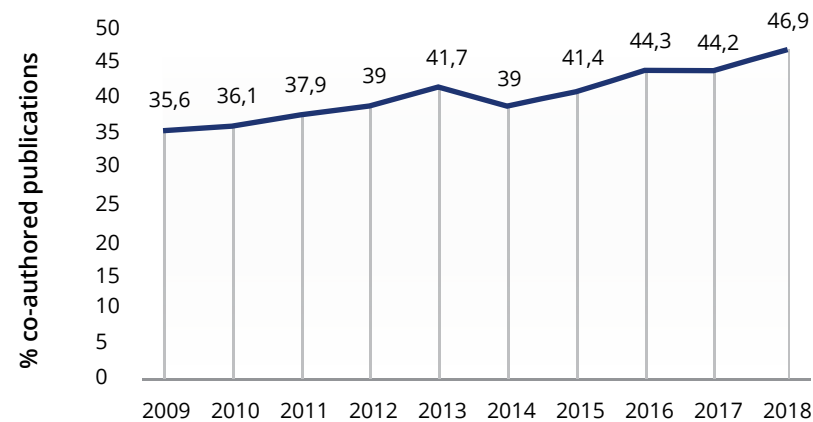

Figure 3.10. UP's increase in the percentage of co-authored papers, 2009 to 2018

Also based on citations, Figure 3.12 shows the increase in the number of articles published that appear in the top quartile of journals globally.

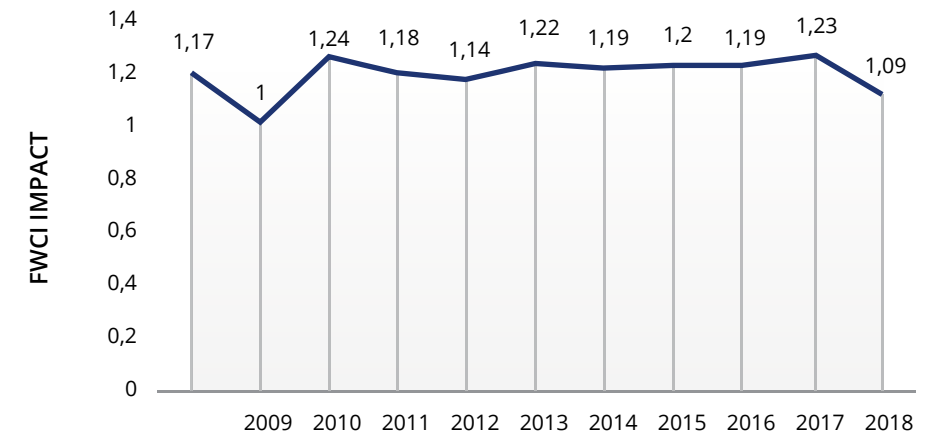

Figure 3.11. UP's field citation impact performance, 2009 to 2018

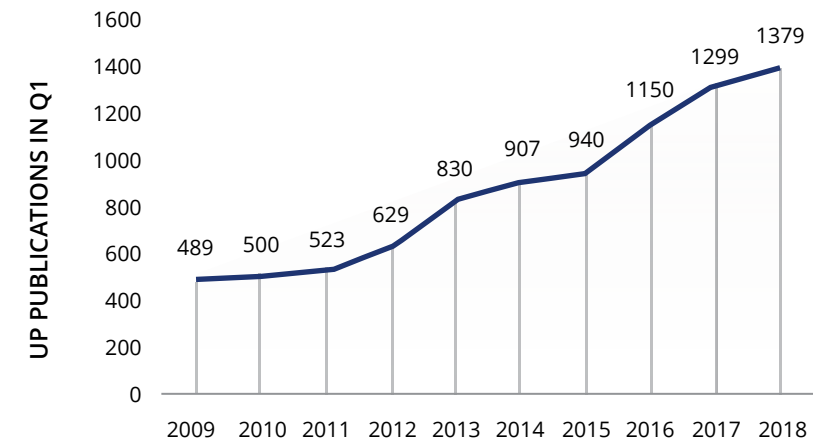

Figure 3.12. Increase in the number of papers in Q1, 2009 to 2018

<sup>48</sup> UP 2025, p.6.

<sup>49</sup> University of Pretoria. Strategic Plan 2017–2021. November 2016 [R38/16]



### Knowledge fields and visibility

The visibility of UP's lead researchers is demonstrated in the Essential Science Indicators (ESI) database which provides performance statistics based on articles published in journals indexed by the Web of Science (Clarivate Analytics), and the citations of those articles.

The ESI database covers 22 broad knowledge fields. For several years, UP was rated in the top 1% globally in six of the 22 knowledge fields, as is shown in Table 3.9. In 2017, UP gained two further fields, Immunology and Microbiology, taking to eight the knowledge fields in which UP's research output was ranked among the top 1% globally.

A further ESI measure identifies the top 1% of scientists internationally, based on citations. In January 2019, 53 UP scientists were positioned in this top international category (compared to 35 in 2017), illustrating the strengthening of research excellence and visibility achieved at UP. The same ESI database identifies 'top papers', based on citations. In 2018, 145 papers co-authored by UP researchers fell in this category, compared to 100 in 2017 (and 101 in 2016).

Table 3.9. UP's international standing in ESI knowledge fields

	# of papers			Citations			Citations per paper		
	2016	2017	2018	2016	2017	2018	2016	2017	2018
Agricultural sciences	505	554	580	3 122	3 600	3 995	6,18	6,50	6,89
Clinical medicine	1 007	1 203	1 306	9 325	11 915	13 740	9,26	9,90	10,52
Engineering	915	1 060	1 157	5 244	7 303	8 956	5,73	6,89	7,76
Environmental/ Ecology	791	898	999	8 779	11 131	12 556	11,1	12,40	12,57
Immunology	–	344	373	–	4 714	5 070	–	13,70	13,59
Microbiology	–	470	508	–	5 560	6 290	–	11,83	12,38
Plant & Animal sciences	2 858	3 135	3 241	22 833	27 306	30 585	7,99	8,71	9,44
Social Sciences, General	1 145	1 297	1 383	3 944	4 773	5 319	3,44	3,68	3,85

Source: UP Library Services, ESI (InCites), 2018 (27 Nov 2018); 2017 (11 Jan 2018); 2016 (2 Dec 2016).

<sup>50</sup> Adapted from UP's Annual Report, June 2019.

### World rankings

By 2018, world rankings had become, to a great extent, part of the higher education landscape, and served as a useful benchmark for the performance of institutions. As the number of universities included in the world ranking systems increased, competition has intensified to retain or improve on the relative position of institutions. This reality, among other factors, has meant that universities continually need to focus on strengthening their performance, and national systems, on sustaining investment in higher education.

In summary below, UP's position in 2018:<sup>50</sup>

In the Academic Ranking of World Universities (ARWU) rankings, released in August 2018, UP was the only South African university to improve its ranking. From being positioned in the 501–600 range in 2017, UP was now placed in the 401–500 band, and third nationally (together with Stellenbosch University). In the 2019 Quacquarelli Symonds (QS) rankings, released in October 2018, UP was positioned in the 561–570 bracket, and fifth nationally. In the QS Emerging Economies University rankings, also released in October 2018,

UP was placed in position 45 overall, and in the third position among South African universities, after UCT (22) and Wits (40).

While UP's position in the 2019 Times Higher Education (THE) rankings, released in September 2018, was lower than in the previous rankings (positioned in the 601–800 range and fifth nationally), it was a significant achievement to be placed at 350 on the research measurement globally, and 210 with respect to industry income, both bearing testimony to UP's areas of distinct strength.

The THE Subject Rankings for 2019, released in October 2018 (Arts and Humanities), and in early November 2018 (Sciences), ranked UP in nine subject fields: Law was ranked 76 globally (up 16 positions from 92 in the previous ranking); Arts and Humanities (251–300); Life Sciences (301–400); Clinical, Pre-clinical and Health Sciences (401–500); the Social Sciences (401–500); and, for the first time, Education, and Business and Economics (both in the 301–400 range); Psychology (401+); and Life Sciences (301–400).

In the 2019 QS Subject Rankings, released in February 2019 and based on 2018 performance, UP was ranked in 17 subject fields in the top 500 internationally, six of which are ranked in the top 200: Veterinary Science (43), Development Studies (51–100), Theology and Religious Studies (51–100), Agriculture and Forestry (101–150), Archaeology (151–200), and Architecture (151–200).

In the UK Financial Times ranking of the world's top 100 Executive MBA programmes, released in October 2018, the Gordon Institute of Business Science (GIBS) moved up 20 places to position 67, confirming its position as Africa's top Executive MBA provider. This was the sixth year that GIBS had taken Africa's only spot in the top 100 global business schools worldwide.

As world rankings have become one of the defining features of global higher education — and have gained in influence — it is a significant achievement for UP to have retained its position among universities globally.

### UP's Africa strategy<sup>51</sup>

The University of Pretoria is a university in and of Africa in a multitude of ways. Its identity and strategic trajectory, as captured in UP 2025, are inextricably linked to its place on the continent — from the explicit positioning in the vision statement, to partnerships, academics, students, and research and teaching programmes.

Nevertheless, in 2015, it was considered important that the University develop an intentional Africa strategy. This followed in the footsteps of an earlier investigation, undertaken in 2010, at the time of the development of UP 2025, which explored the full scope of internationalisation. As captured in that report, it is perhaps in the 'way of doing things' that the University's identity is best exemplified and its Africa strategy has found expression. Building on the recommendations of the earlier 2010 investigation, UP's Africa strategy explored in some detail the motifs and assumptions that would inform a formalised Africa strategy. It was clear that the strategy needed to be more than statements and numbers — be this of partnerships, joint projects and students; it also needed to be about values and a conceptual delineation of "strategic positional choices".<sup>53</sup>

In August 2015, the United Nations (UN) published its development agenda, *Transforming Our World: The 2030 Agenda for Sustainable Development*. Precursors to this global framework for development were the African Union (AU) *Agenda 2063: The Africa We Want*, and South Africa's *National Development Plan*.<sup>54</sup>

The AU, and many African governments, had for a while recognised the importance of higher education in development — from technology, innovation and economic development to scientific advancement and knowledge production. The AU *Agenda 2063* is a call to action, as is the *National Development Plan*; both recognise the role of higher education in national and continental development.

On 24 April 2014, Her Excellency Dr Nkosazana Zuma-Dlamini, then the Chairperson of the African Union Commission,

<sup>51</sup> UP's Africa Strategy. 2015. Research excellence from Mamelodi to Cairo. Scholarship from Africa to Africa.

<sup>52</sup> University of Pretoria. 2010. Africa's Global University. Report to the Executive by the Task Team to Develop an Internationalisation Strategy, 31 August, pp.7–8.

<sup>53</sup> T Maluleke. 'Towards an African Strategy for the University of Pretoria.' Report prepared for the UP Africa Strategy (UPAS) reference group appointed by the Vice-Chancellor. July 2015, p.6.

<sup>54</sup> UN Sustainable Development Goals 2030; the African Union Agenda 2063 – The Africa We Want; the National Development Plan – Vision 2030.

delivered a guest lecture at the University of Pretoria. It would be a few months later, in June 2014, that the *AU Agenda 2063* was adopted as an integrated vision and framework for the development of Africa at the AU Summit held in Equatorial Guinea. She commended UP for its efforts in consolidating its identity as a research university, and having done so “as an integral part of the African continent”.<sup>55</sup>

One of the critical problems that remained, was the funding of higher education given the many competing socio-economic needs. This issue was an important discussion point at the first African Higher Education Summit held in Dakar, Senegal in March 2015. UP was selected as one of 15 universities on the African continent to be part of the African Research Universities Alliance (ARUA) launched in Dakar, on Tuesday, 10 March 2014. The aim of this Alliance is to use the pan-African network as a platform through which to strengthen research and postgraduate training on the continent.<sup>56</sup>

South Africa’s problems are tied to the continent’s problems, and so are the solutions. In the same vein, UP’s Africa strategy has been at the heart of the University’s pursuit of excellence. It is a necessity and an imperative that will enable the University to make unique contributions to the development of the people of Africa and the world.

Three examples illustrate impactful inter-continental collaboration during this review period, which also involve international consortia:

### ARUA Centre of Excellence in Food Security

As mentioned above, ARUA was launched in 2015 in Dakar, and together 16 of Africa’s leading research universities committed to contribute to this pan-African network and platform. In 2017, the first call for expressions of interest for ARUA member universities to host Africa Centres of Excellence (ACoE) was announced, with ten subsequently awarded. UP was successful in its bid to host the ARUA CoE in Food Security, in collaboration with the Universities of Nairobi and Ghana, with Prof Hettie (HC) Schönfeldt appointed as the Director.

The ARUA CoE in Food Security was launched in December 2018 at the University’s Future Africa Campus, where keynote speakers and panel discussions focused their respective inputs on the future of food in Africa. Food systems remain a key challenge at the intersection of hunger, poverty and health in Africa. Women and children are particularly at risk. In order to find solutions to food security challenges, a clear imperative is creating a critical mass of researchers who work on common goals to address seemingly intractable challenges related to food systems and security. The focus of the ACoE will be on seeking solutions to addressing food insecurity in Africa.

### The Australia–Africa Universities Network

The Australia–Africa Universities Network (AAUN) was established in 2012. Prof Cheryl de la Rey was the African Co-Chair until 2018, with Prof John (JP) Hearn, University of Sydney, as the Australian Co-Chair of the AAUN. Three new member universities were added in 2018 on the African side: Addis Ababa University, University of Botswana, and Tshwane University of Technology, bringing the total number of institutions in this network to 23 (11 Australian universities and 12 African universities). Priority thematic research areas were food security, mining and minerals, public health and education.

In 2018, Prof Elna (EM) Buys (UP lead researcher), and a team from the universities of Ghana, Makerere and Mauritius, and the universities of Murdoch and Curtin in Australia, was one of eight successful bids to receive funding for a collaborative research project on the foodborne pathogen *Listeria monocytogenes* (Listeria).

### The South Africa–Sweden University Forum

The South Africa–Sweden University Forum (SASUF) was launched in May 2018 at the University of Pretoria in collaboration with the Uppsala University (Sweden), and involved 30 universities. The aim is to strengthen cooperation between academics, students and other relevant stakeholders from industry and government in research, education and innovation. The inaugural SASUF Innovation Week attracted approximately 1 200 researchers participating in the main launch events and in a number of satellite events held across 12 cities in South Africa.



I to r: Prof Lindiwe Sibanda, Prof Alice Pell (Cornell University), Prof Cheryl de la Rey, Prof Louise Fresco (Wageningen University) and Prof Hettie Schönfeldt, at the launch of the ARUA CoE in Food Security

In the 2018 SASUF call for proposals, three UP researchers were granted seed funding with a further nine involved as co-applicants. The three projects, with lead researchers from UP, were:

- User-centric identity management for IoT environments — Prof Jan (JHP) Eloff, the Faculty of Engineering, Built Environment and Information Technology.
- A comparison of postgraduate studies: South Africa and Sweden — Dr Maitumeleng (M) Nthontho, Faculty of Education.
- Symptom management for children with cancer — Dr Ensa (E) Johnson, Centre for Augmentative and Alternative Communication.

The University’s focus on research partnerships in Africa is closely related to pursuing science that transcends disciplinary and institutional divides, and advances the type of science leadership needed to address key challenges in Africa. To

this end, UP actively contributes to the continent’s knowledge base, new research frontiers and planned intervention strategies.

### Research frontiers and new platforms

While UP had an established reputation for excellence in research and remained in the top cluster of research-intensive universities in South Africa, the aspiration to advance the frontiers of knowledge found expression in three platforms initiated during this era which have shaped the future direction of research at the University: the Future Africa Institute and Campus, the Javett-UP Art Centre, and the start of the Engineering 4.0 and the Future Transportation Hub development. In each instance, the research platforms illustrate the nature of research bridging disciplinary and university-community-industry divides, allowing for convergence science and ‘translational’ research, and therefore maximising relevance and impact.

<sup>55</sup> N Zuma-Dlamini. ‘Research Universities and African development’. Lecture delivered at the University of Pretoria, 24 April 2014, p.13.

<sup>56</sup> On 20 April 2014, the University received a letter of congratulations from the Speaker of the South African National Assembly conveying the motion of congratulations on its inclusion in this important body.

Chapter 6 in this volume focuses on these, among others, that bear testimony to the legacy of the University's Vice-Chancellor and Principal, Prof De la Rey.

In brief overview, the following:

- **Future Africa**, established as an institute in 2017, and developed as a research platform and campus on the University's Hillcrest Campus.

Launched on 29 March 2019, the Future Africa concept and infrastructure development recognises that research needs to transcend disciplinary boundaries, and build strategic partnerships and networks. More specifically, Future Africa's vision is to be the place where Africa's leading scientists and scholars from across the world and from a broad range of disciplines will come together to leverage the benefits of transdisciplinary research to address the grand challenges that face Africa and the world.<sup>57</sup>

The interconnected nature of research, and inter- and transdisciplinary research practices, are driven by two pivotal shifts in science: the realisation within the broad science (and science policy) community that the challenges facing humanity are of a global nature and cannot be solved at local scales alone; and related, given the complexity of the problems, disciplinary interconnectedness is required, drawing on a network of expertise often from outside institutional and national boundaries. Different elements that define this context, taken together, require new science leadership and new methods of doing science.

Two programmes aimed at new leaders in the sciences were already well-established by 2018: The African Science Leadership Programme (ASLP), with its fifth group of young researchers from across Africa completing their programme in 2018; and the Tuks Young Research Leader Programme (TYRLP), a capacity development programme aimed at UP's young researchers, which ran its fourth programme in 2018.

- **The Javett-UP Art Centre**, designed to be a major driver of transdisciplinary research, is a distinctive feature in the capital city's landscape.

The infrastructural development at the iconic site bridges the Hatfield and South campuses, and was nearing completion in 2018. It will house the Javett Foundation's seminal collection

of 20th century South African art, the Mapungubwe collection of which UP is the custodian, selected pieces from the University's collections, and the Centre's own curated and visiting collections. The Javett-UP Art Centre will also promote new developments in conservation and storage methods. With funding from the Andrew W Mellon Foundation, the University will be the first in the country to offer a master's degree in Tangible Heritage Conservation. This programme, launched in 2018, draws on the humanities, social sciences and the natural sciences.

Research themes such as historical studies and tourism, capital cities, the human economy, inequalities, decolonisation, and demography were already active at the time, and were identified as key focus areas, funded through the Javett Foundation and the AW Mellon Foundation.

- **Engineering 4.0**, developed as a three-way partnership between the University, the South African National Roads Agency Limited (SANRAL), and the Council for Scientific and Industrial Research (CSIR).

The Engineering 4.0 development demonstrates the impact of partnerships between government, industry and science where collective strength and institutional mandates and priorities are aligned.

The research platform is part of UP's research focus on future transportation and smart cities, linked to the impact of the fourth industrial revolution (4IR). The vision is to have a research hub where industry, academia, government and research students can develop future innovation to make South Africa and Africa a smart country and continent. The space planning and designs that were produced for this facility promised a vibrant interactive and state-of-the-art facility that would hold its own among the best in the world, while exposing both students and the industry to cutting-edge research, training and materials testing.

The Future Transportation Hub will be housed in the new Engineering 4.0 facility on the Hillcrest Campus, which is strategically situated in the Innovation Corridor between the University, the Innovation Hub and the Department of Science and Technology. The sod-turning ceremony took place on 4 December 2018, with the completion of the facility planned for December 2019.

## 6 | Service, engagement and impact

UP 2025 commits the University to proactive engagement, extending from activities tied to local communities, to societal engagement and service. As expressed in the long-term strategy:

*"In essence, community engagement is about civic responsibility and citizenship, and linking the best of the research and teaching skills of staff and students to the specific needs of diverse communities, thus giving effect to one of the 'public good' dimensions of universities. In turn, student life and the attributes developed are enriched through their service and engagement."*

The three sections that follow describe different elements of engagement, service and sustainability that were characteristic of this review period.

### Community engagement

Depending on the position taken, the purpose of community engagement has variously come to be known as building social capital, acting on social responsibility, or developing a critical citizenry. By 2018, the University had successfully run community engagement programmes for more than a decade. Students earned credits towards their degrees, while applying their knowledge in the service of communities. Volunteers supported activities in communities or initiated projects of their own. Faculties structured community engagement to fit the purposes of programmes and to expose students to the lived realities of communities whom they were likely to serve as professionals, once graduated.

The Community Engagement Office, located in the Department for Education Innovation, was mainly responsible for curriculum-related community engagement activities. In 2018, approximately 30% of all students (19 500) were involved in community engagement for credit. In addition, volunteers from approximately 120 student societies contributed to the sustainability of the many community sites of learning.

There is little doubt that UP's community engagement initiatives were significantly strengthened by the involvement in two global networks of universities, the University Social Responsibility Network (USRN), and the Talloires Network of Engaged Universities. Both are committed to strengthening the civic roles and social responsibilities of universities. In

April 2017, eighteen members of the USRN from nine member universities visited the University of Pretoria for an exchange of ideas on social responsibility.

Prof De la Rey served as Vice-Chair of the Talloires Network from 2014 to 2018.

### UP's anchor strategy

Over time, the University has maintained close links with government and industry. These relationships have shaped UP's research and teaching programmes at many levels. The University's responsiveness to contexts within its sphere of influence is also demonstrated in its engagement with community stakeholders, and more broadly, with society. Deliberate efforts are made to create space for dialogue and the exchange of ideas related to the welfare of local communities.

As Prof De la Rey noted in her inaugural address,

*"... a strong, resilient and peaceful democracy depends on a shared sense of civic responsibility, social interconnectedness and social justice. It is our firm intention to embrace a social, developmental perspective to our human capital development role so that we produce graduates who are valued not only for their academic and technical skills but also for their role in bringing about a more harmonious and equitable society."<sup>58</sup>*

<sup>57</sup> See <https://www.up.ac.za/future-africa>

<sup>58</sup> Installation of Vice-Chancellor and Principal, Prof Cheryl de la Rey, 16 April 2010.

There are numerous examples of such collaboration and dialogue at departmental, faculty and institutional levels which have become inscribed in the actions of the institution. Two anchor strategies are described below, followed by a brief sketch of the University's economic impact.

### The Hatfield precinct

In 2015, planning started towards the development of an anchor strategy rooted in the idea that universities can create social change "beyond the university gates".<sup>59</sup> A central premise was that improving neighbourhoods would help attract students and staff, as well as businesses and services, and may represent a new model for socio-economic integration beyond the 'gated' framework typical of ivory tower institutions.

In support of this anchor strategy, UP established the Office of Government Relations and Special Projects (GRaSP), with Prof Denver Hendricks as manager of this initiative in the Office of the Vice-Chancellor. The focus of GRaSP was to work closely with the Hatfield City Improvement District (HCID) to create a clean, safe, secure and attractive environment beyond the University's physical boundaries.

A baseline document was prepared for the City of Tshwane (CoT) for incorporation into its regional spatial development framework. UP secured funding for the development of an urban design framework from the Kresge Foundation (US), and a consortium of engineering firms was awarded the contract to develop plans for the future Hatfield.

The project was highly successful and received the 2018 Gauteng Premier's Service Excellence Award in the category: Creating Safer Communities. It also resulted in increased collaboration between the University and the CoT.

Linked to the Hatfield anchor strategy was the Mamelodi learning collaborative.

### The Mamelodi Collaborative

The Mamelodi Campus, home to UP's extended degree programmes, is in many ways regarded as 'an oasis' in the community. One of the initiatives, started in 2017 with the US-based Rutgers University-Newark, is the Mamelodi Community of Learning Collaborative (MCLC).

The aim of the Collaborative is to reduce the cycle of poverty that underprivileged communities typically face. In aid of this goal, the Kresge Foundation granted partnership funding to UP and RU-Newark to implement anchor institution strategies in Mamelodi and Newark, respectively. These are handled in two ways. First, multi-level interventions at the pre-university level for school-going youth via after-school programmes and mentoring; and secondly, the establishment of on-campus clinics and other community initiatives.

The pre-university programmes involve learners from Grade 8 to Grade 12 at all 20 high schools in Mamelodi. Clinics include a Business Clinic, a Legal Clinic, an Animal Health Clinic, and Siyathemba Occupational Therapy Clinic.

Underpinning the aim of 'softening the hard borders' between campus and community is the belief that UP and, indeed, universities everywhere have the ability to effect substantive change in these hard-pressed communities, if they bring to bear all their resources on the challenges facing those just beyond the walls.



Members of the Mamelodi Community of Learning Collaborative, UP and RU-Newark University

### UP's economic impact

In 2018, UP commissioned a study on the economic impact of the University of Pretoria in Tshwane, Gauteng and South Africa. The study, based on 2016 data, found that the University and its value chain contributed significantly to the local, regional and national economy, inter alia in the following ways:

Its employment constituted 0,5% of total employment in Tshwane, while the University, its suppliers and their suppliers added R7,6bn (or 7%) to Tshwane's GDP.

UP made a significant contribution to the national economy through its capital expenditure, the payment of tax, the employment of staff, the use of suppliers, as well as the consumption expenditure by students, leading to a contribution of R39bn to the South African economy.

UP supplied 4% of Gauteng's formal workers and UP graduates represent 13,7% of the highly skilled workforce in Gauteng and 7,7% of the highly skilled workforce in South Africa.

The report, using official statistics from the DHET, from 2001 to 2016, shows that UP contributed, cumulatively, 10% of all graduates in South Africa, 23,8% of Gauteng-based graduates, and 33,9% of Tshwane-based graduates.

Over the longer term, the University had contributed significantly to the knowledge base of South Africa. In respect of the period between 1930 and 2016, UP graduates accounted for 18,5% of all graduates living in Gauteng and 12,5% of all graduates nationally.

<sup>59</sup> D Hendricks and J Flaherty. 2018. Integrating the edges: University of Pretoria's neighbourhood anchor strategy, *Development Southern Africa*, 35:5, 689-700, DOI: 10.1080/0376835X.2018.1433024

**UP Expert Lecture Series**

The Expert Lecture Series, initiated by the Vice-Chancellor and Principal in 2010 at the time of the development of UP 2025, is an example of an outreach activity of the University where it opens to the public some of the excellence achieved. The purpose is to provide a platform for top scholars at UP to engage with a general audience on significant developments

in their fields of expertise that are likely to have an impact on the future.

The general audience typically includes industry representatives who serve on faculty advisory boards, members of government and the diplomatic corps, sponsors and donors, UP alumni, members of Council, and the university community.

Prof Robin Crewe delivering the first Expert Lecture, 26 August 2010



Hosted by Prof De la Rey, this prestigious series of public lectures showcased some of the best intellectual endeavour at UP and became a feature of the intellectual life of the University. Between 2010 and 2018, there were 22 expert lectures.

1	Prof Robin Crewe, 26 August 2010	Doomsday scenarios and the fate of the African honeybee population
2	Prof Christof Heyns, 27 October 2010	Universal Human Rights — asking for too much?
3	Prof Stella Nkomo, 13 April 2011	Woman in Leadership: progress and challenges
4	Prof Madeleine du Toit, 16 May 2011	Welding — the Achilles heel of the South African manufacturing industry?
5	Prof Thokozani Majozi, 25 May 2011	21st Century clouds above synthesis of batch chemical processes
6	Prof Sarah Howie, 4 August 2011	Quality education for all — South Africans quest for the 'Holy Grail'
7	Prof David Medalie, 1 November 2011	'To retrace your steps': The power of the past in post-apartheid literature
8	Prof Julian Müller, 5 September 2012	(Practical) theology: A story of doubt and imagination
9	Prof Michael Pepper, 31 October 2012	Stem cells: Current reality and future promise
10	Prof Lorenzo Fioramonti, 7 May 2013	'Gross domestic problem': The dark sides of GDP and why they matter for Africa's future
11	Prof Frans Viljoen, 12 June 2013	Human rights in a time of homophobia: an argument for equal legal protection of 'sexual minorities' in Africa
12	Prof Sunil Maharaj, 21 August 2013	The broadband divide: Where is the digital highway going?
13	Prof Mike Wingfield, 23 October 2013	Global tree health: Can we rise above the gathering storm?
14	Prof Maxi Schoeman, 5 March 2014	A crisis of leadership? Reflections on 20 years of democracy
15	Prof Nick Binedell, 20 August 2014	Grand strategy and leadership: Prospects for the next 20 years of democracy
16	Prof James Ogude, 15 October 2014	'Great expectations and the mourning after': A literary anatomy of post-independence politics in Africa
17	Prof Xiaohua Xia, 4 March 2015	Energy efficiency and demand-side management: Do they still come to the rescue?
18	Prof Robert Millar, 26 August 2015	A hitchhiker's guide to the galaxy of brain/body dialogues
19	Prof Charles van Onselen, 21 October 2015	'Sunny places for shady characters'. The making of work class cultures in Southern Africa's mining revolution, c.1886-1914
20	Prof De Wet Swanepoel, 28 March 2017	Rise of an invisible epidemic — fighting hearing loss with advances in technology and connectivity
21	Prof Martin Schwellnus, 17 August 2017	The drug everyone should take: Why, how and what?
22	Prof Mike Sathekge, 1 August 2018	Theranostic: See it, treat it!



Ad Destinatium VI | 2009-2018

## 7 | Transformation

Transformation is essentially about change — at individual and institutional levels. It is “a permanent ideal”.<sup>60</sup>

In the broadest sense, transformation at UP is anchored in the University’s core functions and therefore in the different dimensions that make up its long-term strategy, UP 2025, and subsequent one and five-year plans. Tethered to the policy development era that culminated in the first post-apartheid *White Paper* (1997), the transformation imperatives seemed clear. As stated by Minister Bhengu:

“The higher education system must be transformed to redress past inequalities, to serve a new social order, to meet pressing national needs and to respond to new realities and opportunities.”<sup>61</sup>

Informed by several policies, commissions and frameworks developed at national, continental and global levels, transformation at UP became a cross-cutting project for change, spearheaded by the University’s leadership, and driven by line managers at all levels of the institution.

UP 2025 sets out to align the University’s processes of transformation with the ‘navigational markers’ where diversity is “embraced as a necessary condition for improving the quality, relevance and impact of the University.”<sup>62</sup>

It was understood, at the time of developing UP’s long-term strategy, that the challenges, in the main, related to increased access and institutional transformation, as articulated in the 1997 *White Paper*. Equally important were the demands on higher education to ‘make a difference’. These were some of the great expectations of universities at the time. It was within this historic context that the long-term plan attempted to capture “the cornerstones of a common vision and understanding of the University’s role and identity in the context of multiple and changing demands”.<sup>63</sup>

In writing this sixth volume in the *Ad Destinatium* series, the view was often expressed<sup>64</sup> that the previous two volumes — *Ad Destinatium IV* (1993–2000) and *Ad Destinatium V* (2001–2009) — give detailed historic reference to transformation at UP during these periods. While the period 2009 to 2018 built on these eras, it also became a distinct period in the history and development of the University.

However, it has been pointed out that “what needs to be transformed and the direction of that transformation are not static: they are both contextual and dynamic”;<sup>65</sup> in other words, the nature of transformation (or social phenomena) means that institutions need continually to recalibrate their strategies and priorities. So, for example, achieving access, equity and redress would have manifested differently in 1997, as opposed to the start of the development of UP 2025; or

what curriculum change meant in 2016 would be different from the broad consensus understanding in 2010, as reflected in the UP Academic Plan. In the context and aftermath of the #FeesMustFall movement, decolonising the curriculum became an institutional imperative.

There were important historic markers in this era which necessitated a realignment of institutional strategies.

As noted in UP’s second five-year plan (2017–2021), “significant changes in the University’s external environment, especially the seismic changes in 2015 and 2016”, meant that UP’s strategic goals needed to be reconsidered. At the height of nation-wide student protests, in 2016, transformation was placed at the centre of the University’s agenda.

“Transformation is an overarching institutional imperative that requires a fundamental change of the University’s culture by embedding diversity, inclusion and equity, in every effort, aspect, and level of the University. The goal is to make transformation a norm that is practiced by everyone within UP.

Key outcomes:

- Enhanced student and staff diversity profiles.
- University of choice for talented students and staff from diverse backgrounds, and also an institutional partner of choice.
- Institutional cultures and practices that are welcoming to students and staff from diverse socio-economic and cultural backgrounds.
- Positive image as a transformed university.”<sup>66</sup>

<sup>60</sup> Former Chief Justice Pius Langa, quoted in the Report of the Independent Transformation Panel of the University of Pretoria Council, 23 November 2016, p.21.

<sup>61</sup> *White Paper 3*, 1997. Foreword.

<sup>62</sup> UP submission to the South African Human Rights Commission. Investigation into allegations of racism at tertiary institutions in South Africa. 1 August 2014.

<sup>63</sup> UP 2025, pp. 2 & 4.

<sup>64</sup> This important point was raised by members of the editorial board who were closely involved in the construction of the previous two *Ad Destinatium* volumes.

<sup>65</sup> L Lange. 2014. Rethinking Transformation and Its Knowledge(s): The Case of South African Higher Education. *Critical Studies in Teaching & Learning*, Vol2(1), p.6. DOI: 10.14426/cristal.v2i1.24.

<sup>66</sup> See also L Lange and T Luescher-Mamashela. 2016. ‘Governance’. *South African Higher Education Reviewed: Two decades of democracy*. (CHE: Pretoria).

Several initiatives were set in motion to strengthen transformation at UP across all levels of the institution.

In Chapter 1, two vignettes are presented, the first capturing a new era of leadership; and the second, a student perspective on protests, from the Editor, at the time, of the student newspaper *Perdeby*. In [Chapter 5](#), a brief history is given of developments, leading up to the establishment of the Transformation Office in early 2019, and the approval of the Anti-Discrimination Policy and Manual.

In the sections that follow below, an overview is given of the main events and initiatives during the period 2009 to 2018.<sup>67</sup>

### Core Committee for Transformation

In the latter half of 2009, a Core Committee for Transformation was established. The eight-member committee was chaired by Prof Nthabiseng (NA) Ogude (Vice-Principal: Teaching and Learning). The name of the Committee was later changed to the Committee for Transformation. The mandate was to refine the institutional objectives and priorities related to transformation; to facilitate a rigorous assessment of transformation at UP; and to develop an appropriate response to what came to be referred to as the Soudien Report.<sup>68</sup>

The Committee met for the first time on 9 September 2009.

UP faculties and departments were requested to take stock of their transformation initiatives. Transformation committees were established as sub-committees of the institutional Committee for Transformation and were overseen by the respective Deans and Directors. In addition, a portfolio for transformation was added to the Student Representative Council and other student leadership structures, including Residence House Committees.

The report of the Ministerial Committee on Transformation, Social Cohesion and the Elimination of Discrimination in Public Higher Education Institutions had widespread repercussions in the university sector. Chaired by Prof Crain Soudien, the report concluded that seemingly little had changed in post-apartheid higher education institutions, given the widespread perceptions of racism and social exclusion documented across the sector.

Although the study was criticised for its methodology and the use of anecdotal evidence, it was a wake-up call for universities who scrambled to review transformation processes, policies and institutional practices.

At the request of Higher Education South Africa (HESA), the umbrella body for public universities, UP prepared an Integrated Transformation Plan, submitted in 2011.

### Institutional culture survey

In 2010, UP's Committee for Transformation recommended that external consultants be appointed to undertake a survey of UP's institutional climate and culture. An open tender process was followed to identify suitable consultants, and an internal stakeholder reference group was established.<sup>70</sup>

The consultants, Laetoli, were appointed. The survey was made available in English, Afrikaans and Sepedi, and sought to determine the perceptions of staff and students. The consultants' report on the survey results was received in December 2011, and presented to faculties, departments and student structures in 2012. The results served as a baseline for further interventions.

It was agreed that a follow-up survey would be conducted five years later (in 2016) to monitor progress made in identified areas that required change. This did not happen at the time, as the higher education sector was mired in instability, as a result of the Fallist movement. Nevertheless, the findings and recommendations arising from the institutional culture survey informed the development of a transformation framework and plan, *UP Journey for Change*, approved by UP Council in 2012.<sup>71</sup>

### UP Journey for Change

The framework and plan for transformation was future-oriented and placed a premium on the recognition of difference, diversity and inclusion. As a dynamic and evolving roadmap, the *UP Journey for Change* and associated departmental and faculty transformation plans were revised and updated several times between 2012 and 2017, with regular reporting and ongoing oversight.

Several opportunities for dialogue were created, among which were the *Re-a-bua* dialogues.

### Re-a-bua dialogues

The *Re-a-bua* dialogues were developed and rolled out over a period of 12 months, starting in September 2013. The name *Re-a-bua* is Sesotho for 'we are talking'.

Facilitated by the Diversi-T Change Management Consultancy, and led by a member of the Executive, Patience (P) Mashungwa (Executive Director: Human Capital and Transformation), this facilitated intervention provided a platform for dialogue, enabling individuals to break down stereotypes, and positively to contribute to building social cohesion and an inclusive culture at UP. In essence, the dialogues provided a safe space for staff and students to have

conversations about the kind of transformed university they envisaged. About 2 000 staff and 300 students from various student structures participated in the dialogues.

Initiatives undertaken in *UP Journey for Change* and the *Re-a-bua Dialogue Series* were advanced by the Transformation Lekgotla Workstreams of 2016.<sup>72</sup>

### Student life dialogues

An extensive, participatory process was followed to review and update residence rules and practices. The project was finalised in 2014.

<sup>67</sup> UP Plan 2017–2021, pp. 9&13.

<sup>68</sup> This section is adapted from a text prepared by Michelle Viljoen, Executive Operations Manager, Office of the Vice-Principal: Students.

<sup>69</sup> The Report of the Ministerial Committee on Transformation and Social Cohesion and the Elimination of Discrimination in Public Higher Education Institutions, released in June 2009.

<sup>70</sup> HESA, the representative body of the public universities in South Africa, was renamed Universities South Africa (USAf) in July 2015.

<sup>71</sup> The group comprised representatives of the Institutional Core Group, the Institutional Forum, union/employee organisations, the Student Representative Council, Department of Human Resources, as well as organisational development and legal expertise.

<sup>72</sup> University of Pretoria. 2012. *UP Journey for Change*.

In 2015, a two-day Student Life Indaba was held on 31 July and 1 August with a view to developing a shared vision for student life at UP. The theme was 'Together, creating the ideal student life'. The programme for the indaba did not spend significant time in plenary. Instead, the 130 participants from student and staff stakeholder groups shared their experiences in pairs, small groups and in breakaway sessions. There was a specific emphasis on how campus life could support students academically, and how students could contribute. Considerable time was spent in 'appreciative inquiry', sharing stories of success and looking at how UP could build on what was working well across the University. The constructive conversations were facilitated by two external professionals.<sup>73</sup> Main challenges and themes were identified, along with proposed strategies to address challenges. The shared vision for student life was subsequently approved by the Senate Committee for Student Life.<sup>74</sup>

In 2015, the Minister of Higher Education and Training, Dr Blade Nzimande, called a meeting with the four former Afrikaans universities — UP, and the universities of the Free State, North-West, and Stellenbosch. The purpose of the meeting was for the Minister to be briefed on matters of transformation, specifically related to recent acts of racism at the institutions. Council Chairpersons, Vice-Chancellors and Registrars of the universities were invited to attend.

The meeting was held in Parliament Chambers, Cape Town, on 16 April 2015.

### The Fallist movement

The #FeesMustFall movement was by far one of the most extraordinary transformative developments in the history of South Africa's post-apartheid higher education. It destabilised campuses for extended periods and impacted on all institutions.

Widespread student protest action across the country saw violent disruptions, the destruction of property and campus closures. The transformation project was hijacked, leading to some unintended consequences. It had, nevertheless, a huge impact on the moral fibre of South Africa, and even a global impact, prompting a push for decolonising the curriculum and the insourcing of service staff.

The University of Pretoria did not escape these protests, and campuses had to close. Academic activities were suspended during a resurgence of violence and intimidation in September 2015 as part of the #UPrising and #AfrikaansMustFall protests that erupted on the Hatfield Campus.

On 26 and 27 October 2015, the Vice-Chancellor and Principal, Prof Cheryl de la Rey, signed an agreement on behalf of the University, with the formal and informal student organisations who had submitted a memorandum of demands under the banner of #UPrising. The University committed itself to a zero percent increase in the fees (including initial instalments, tuition, residence accommodation and meals) for all students for 2016. This agreement marked a watershed moment in the history of the University of Pretoria and would have far-reaching, long-term financial implications for the University.

There were several demands, which included that:

- The University would not institute disciplinary action against students who participated in the initial protest action or were arrested during this time for defying a Court Order prohibiting violence and the destruction of property.
- The academic programme would be reorganised to ensure that students could catch up on academic work that they missed during campus closures.
- Residence students whose accounts were in arrears, would not be refused residence re-admission in 2016. The residence food model would be re-evaluated to accommodate student needs and preferences; that UP would provide additional meal support, transport services for students and more affordable student housing options.
- The University would assist, from its own funds, all students who qualified for NSFAS in 2015 and 2016, and who were not assisted.
- The Vice-Chancellor would consult with all stakeholders on the demand for a single language of instruction.

The consultative processes on the language of instruction that followed, ultimately resulted in the change of language policy, with English becoming the only language of instruction in all but a select few programmes that require teaching in other languages (see below).

At the beginning of 2016, and sporadically throughout the year, there was a resurgence of protest action. In addition to fees, further rallying points remained Afrikaans as a language of instruction, and the outsourcing of workers.

An Insourcing Commission was established, and extensive negotiations resulted in agreements about permanent employment, salary increases, the harmonisation of conditions of service and operational measures to accommodate the large cohort of service staff who were to be placed on the UP permanent staff establishment.<sup>75</sup>

There were many individuals and groups who supported the University of Pretoria through these tumultuous times, and who made themselves available to assist. The University also solicited the assistance of the South African Council of Churches (SACC), the University's team of chaplains, and the Higher Education Parents Dialogue (HEParD) who played a crucial role in mediating between various groups of students and UP management.

In response to a question posed by the Independent Transformation Panel of Council relating to an allegation that UP management refused to recognise protesting students as having any stake in the University, Prof De la Rey commented as follows:

"The protesters act in support of a worthy social justice cause and the University community is deeply concerned about the plight of poor, academically meritorious students, but intimidation, violence and threats cannot be tolerated. South Africa's democracy has been hard-won and all citizens including students should utilise our democratic institutions to resolve issues."<sup>76</sup>

### Lekgotlas and workstreams

In the context of student protest and disruption at the University, two facilitated Transformation Lekgotlas were held on 5 March and 28 May 2016, respectively. The full-day proceedings took place off-campus and were facilitated by a team appointed by #AccessThuto, led by retired Constitutional Court Judge Yvonne (Y) Mokgoro. The chief facilitators were Jabu (J) Mashinini and Prof Julian (J) Sonn. The services were delivered *pro bono*.

An important outcome of the first lekgotla was that three internal workstreams were constituted — on institutional and residence culture, curriculum transformation and language:

Prof Anton (A) Kok was the coordinator of the internal workstreams on transformation — curriculum; institutional culture and residence culture.

- Prof Derick (D) de Jongh was the chairperson of the workstream on institutional and residence culture, which was split into two groups with Edwin (ET) Smith the facilitator of the residence culture workstream.
- Prof Norman (D) Duncan was the chairperson of the curriculum workstream. He also led the earlier 2015 Senate-appointed task team on UP's language policy.
- Prof Eric (E) Buch was the chairperson of the language workstream.

The workstreams reported on progress at the 28 May 2016 lekgotla, and over the months that followed, developed concrete, actionable proposals and recommendations that would feed into the relevant UP structures, including the Institutional Transformation Committee. All documentation produced was also made available to staff and students on the UP Intranet.

### Curriculum workstream

In 2016 alone, eight meetings of this workstream were held between 8 April and 26 October, with the work undertaken placing renewed emphasis on teaching and classroom practices. The curriculum transformation framework developed went through several iterations. Titled, '*Reimagining curricula* for a just university in a vibrant democracy', it was approved by Senate in 2017.

In addition, a public lecture series, 'Curriculum transformation matters: The decolonial turn', was initiated in 2016 by Prof Duncan. The lecture series sought to stimulate interest and facilitate participation in the formal curriculum transformation process. All faculties developed curriculum transformation plans and, at departmental and faculty levels, a series of lectures and workshops were initiated on curriculum transformation.

<sup>73</sup> As reported by Prof Tinyiko Maluleke at the Council Workshop of 14 September 2017. [R29/17]

<sup>74</sup> Anthony Wilson-Prangle and Leon Mdiya.

<sup>75</sup> By the end of the period under review, these harmonisation processes still were not concluded.

<sup>76</sup> Report of the Independent Transformation Panel of the UP Council. 23 November 2016, p.34.



Also, as documented in Section 4 above, and in Chapters 4 and 5, there were several initiatives that strengthened curriculum transformation and UP's commitment to student success and well-being.

### Institutional culture workstream

Given the complexity and vast scope of the work of the institutional culture workstream, a decision was taken at the second lekgotla held in May 2016, to disaggregate residence life from institutional culture.

The institutional culture workstream held ten meetings in 2016, and developed a planning framework that included guiding values, themes and concrete proposals. Detailed documentation was collected over the period as a future resource. Recommendations included the promotion of robust dialogue on transformation between staff and students, using key structures and representative bodies; the establishment of a communication campaign to inform,

advocate and engender co-ownership of the UP brand; and the design of physical social learning spaces on campus to promote dialogue about institutional culture transformation.

### Residence workstream

In the transformation focus on residence life, facilitators were trained who were previously residents and leaders in the residence community to facilitate conversations which started with heads of residences. A total of 19 residences conducted these discussions.

Following on the discussions held in 2016, and in line with the goal of transforming student residence life, a series of workshops were held in 2017, covering the topics of inclusivity, diversity and transformation. These workshops, facilitated by Inclusivity South Africa (InSA), focused on cultural inclusiveness in the residences. In the same year, the Residence Placement Policy was revised, with a deliberate focus on supporting integration and diversity in residences.

### Language workstream

On the basis of the work undertaken by the language work stream, Senate and Council approved a new language policy in 2017, for implementation in 2019 (see also below).

This was a major historic marker of change at the University of Pretoria. For the first time since the early years of the University's establishment in 1908, UP adopted English as the medium of instruction. Afrikaans would be maintained as a language of scholarship, while support and resources would be allocated to develop Sepedi to a level of scientific discourse.

The amended language policy, it was argued, was in response to the changing student demographics, aimed at promoting social cohesion, facilitating student success and preparing students for a globalising world. Even though the policy was carefully considered, there were divergent views.

Legal action instituted against the University to declare the new language policy unconstitutional did not succeed. The application by AfriForum against the decision of the University's Council to phase out Afrikaans as medium of

instruction was heard in the High Court on 1 December 2016. On 15 December 2017, the High Court rejected the application, with costs.

### Independent Transformation Panel

In addition to the work of the transformation lekgotlas and workstreams, the UP Council, at its extraordinary meeting on 27 February 2016, agreed to appoint an Independent Transformation Panel to advise Council on issues of transformation. The Panel, it was agreed, would comprise a small number of independent, high-profile persons.

Chaired by retired Judge Johann (JV) van der Westhuizen, the members were Khanyisile (K) Kweyama, Dr Danie (D) Langner, Prof Sheila Onkaetse (SO) Mmusi, Judge Jeremiah (JBZ) Shongwe, and Prof Adam (A) Small.

The Panel functioned independently from the Executive and the internal transformation workstreams. Two reports were prepared, the first, on language policy, was submitted to Council on 17 June 2016; the second, on institutional culture, was submitted on 23 November 2016.

Prof De la Rey and members of the Executive meeting with students, October 2015



Judge Johann van der Westhuizen, was the founding Director of the UP Centre for Human Rights and a previous member of the UP Council. After retiring as a judge of the Constitutional Court, he took up an appointment as an extraordinary professor at the Centre for Human Rights.

Khanyisile Kweyama, was the CEO of Business Unity South Africa (BUSA), Chair of the Board of Trustees of Brand South Africa, and member of the National Planning Commission.

Dr Danie Langner, was the MD of the *Federasie van Afrikaanse Kultuurvereniginge (FAK)*, MD of the NP van Wyk Louw Centre for Community Studies, and leader of the Voortrekker movement.

Prof Sheila Onkaetse Mmusi, was the Chairperson of the Setswana Language Commission of the Academy for African Languages (ACALAN) of the African Union, member of the Board of Director at Plus94Research, and Head of the Department of Media Communication and Information Studies at the University of Limpopo.

Justice Jeremiah Shongwe, served as judge in the Court of Appeal and was former Deputy Chief Justice of the North Gauteng High Court.

Prof Adam Small, was a philosopher, poet and playwright. Sadly he passed away on 25 June 2016, before the second report of the panel was completed.

# TRANSFORMATION CHARTER of the University of Pretoria

## Language policy

On 25 May 2016 an open invitation from the Panel was sent to internal and external stakeholders, inviting written submissions, and indicating the broad areas of interest. Seventy-eight submissions were received, which reflected a divergent range of viewpoints. There was broad consensus, however, that UP's language policy should be "based on principles of fairness and equality and that it should aim to uphold the dignity of students and their rights".<sup>77</sup>

The Independent Panel referenced, in its report, the entire proposal of the Senate-appointed Language Task Team. It noted that this proposal was presented at the internal

workstream lekgotla held on 28 May 2016; and that it would be placed before Senex and Senate meetings on 2 and 20 June 2016,<sup>78</sup> and Council on 22 June 2016.

The Panel's own recommendations concurred with the draft policy developed by the internal language workstream; in essence, that the existing UP language policy of 2010 be replaced by a new or amended policy; and that English was recommended as the primary language of teaching and learning. There were twelve recommendations linked to these main points which, in varying degree, illuminated the complexities involved in bringing about a contextually appropriate and fair language policy for the University of Pretoria.

## Institutional culture

As with the language policy, internal and external stakeholders of the University were invited to make submissions to the Panel. The invitation for submissions was widely distributed to national institutions and political parties, and internally, to Deans, individual academics and registered student societies.

Forty-seven submissions were received. In addition, the Vice-Chancellor and her management team were asked to respond to specific questions posed, based on the issues raised in the submissions received. Prof De la Rey's detailed response was received on 21 November 2016.

The Panel's final report was submitted to Council at its meeting on 28 November 2016. Recommendations, similar to those of the workstreams, focused on both short- and long-term proposals for action.

Long-term recommendations included the review of policies on student admission and financial support mechanisms to ensure equity; the evaluation of graduation rates; and the possible impact of funding to develop better support programmes. Short-term recommendations included a range of issues, from the need to formalise human rights awareness training, to cultivating a culture of social responsibility for staff and students.

## Transformation Implementation Plan

In 2012, the Minister of Higher Education and Training, Dr Blade Nzimande, established a seven-member Ministerial Oversight Committee on Transformation. Prof Malegapuru (MW) Makgoba, the Vice-Chancellor and Principal of the University of KwaZulu-Natal at the time, was appointed as chairperson. The purpose of this Committee was to monitor progress on transformation in South Africa's public universities, to serve as an expert advisory body, and to provide independent and external advice to the Minister and the DHET on matters related to transformation.

In July 2017, the Minister appointed new members to the Oversight Committee for a three-year term, and membership was extended from seven to ten members. Prof André (A) Keet, Director of the Institute for Reconciliation and Social Justice at the University of the Free State, succeeded Prof Makgoba as the new chairperson.

<sup>77</sup> The application by AfriForum against the decision of the University's Council to phase out Afrikaans as medium of instruction was heard in the High Court on 1 December 2016. On 15 December 2017, the High Court rejected the application, with costs.

<sup>78</sup> Report of the Independent Transformation Panel of UP Council, 17 June 2016 [R26/16]; Report on Transformation and the UP Institutional Culture. [R46/16]

<sup>79</sup> UP Transformation Implementation Plan, August 2017, p.8. [Rt 478/17]

<sup>80</sup> T Maluleke, September 2017. 'Towards a Framework for the Transformation of Institutional Culture at UP'.

Towards the end of the review period, in August 2017, a Transformation Implementation Plan was finalised and approved by Council. The overarching goal was "to foster and sustain a transformed, inclusive, and equitable University community"; described at the time, "as the very thread that connects the fabric of the tapestry that we wish to create".<sup>79</sup>

Performance indicators were aligned to the University's core indicators.

While institutional transformation cannot be reduced to numbers, it was clear that the leadership of the University had, over three decades, made a concerted effort to develop clear goals, deliberate actions, and concrete targets to achieve the transformation goals it had set itself.

## Anti-discrimination policy

Significant changes were made to many of the University's policies to give substance to the promotion of an inclusive culture and an environment in which students and staff could thrive. Central to these policies was the approval of the Anti-discrimination Policy and Manual in early 2019, the culmination of the many efforts undertaken by the University which created a regulatory framework for transformation, going forward.<sup>80</sup>

# Academic identity



- 1. Economics and Management Sciences
- 2. Education
- 3. Engineering, Built Environment and Information Technology
- 4. Health Sciences
- 5. Humanities
- 6. UP Law
- 7. Natural and Agricultural Sciences
- 8. Theology and Religion
- 9. Veterinary Science
- 10. Gordon Institute for Business Science
- 11. Mamelodi Campus

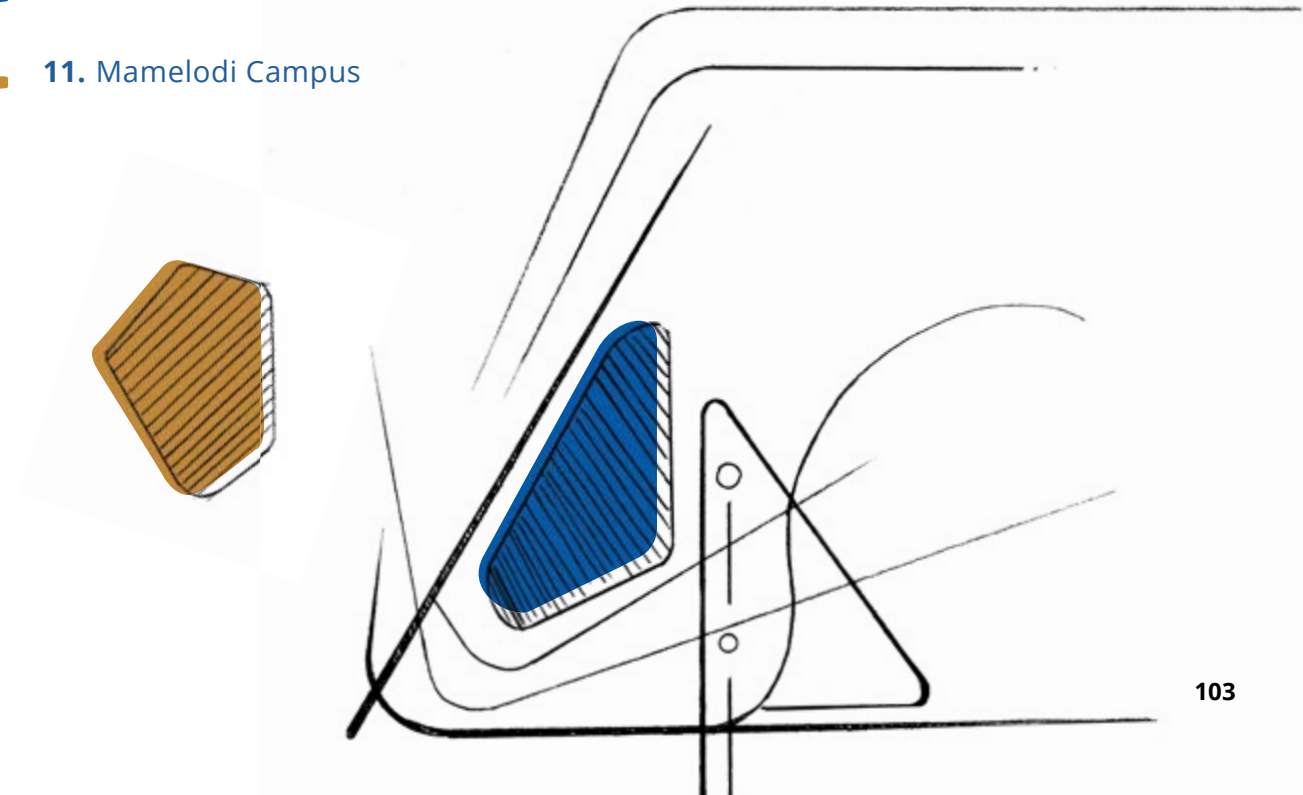



# 1 | Economic and Management Sciences

## DEAN'S OVERVIEW

The strategic direction, achievements, progress and growth on numerous levels during the period 2009 to 2018 demonstrate that the Faculty of Economic and Management Sciences (EMS) had made its mark in the national and international arena.

### *Leadership and strategy*

Prof Carolina (C) Koornhof, appointed in 2003 as Dean of the EMS Faculty, remained in this leadership position until her appointment as UP's Executive Director: Finance in 2011. Prof Jan (JH) van Heerden first served as Acting Dean (March 2011 to December 2011), followed by Prof Niek (NJ) Schoeman (January 2012 to July 2012). The new Dean of the EMS Faculty, Prof Elsabé (E) Loots, was appointed on 1 August 2012.

During the period under review, the Faculty aligned its management and organisational structures with the University's new management model and long-term strategy, UP 2025. The management team was strengthened with the appointment of Deputy Deans. In 2013, Prof Stella (SM) Nkomo was appointed as the first Deputy Dean: Research and Postgraduate Studies, and Prof Schoeman as the first Deputy Dean: Teaching and Learning. Prof Nkomo stepped down at the end of 2016 and was succeeded by Prof Jenny (JM) Hoobler who served as Deputy Dean: Research and Postgraduate Studies in 2017, followed by Prof Van Heerden in 2018. Prof Johan (JGI) Oberholster was appointed as Deputy Dean: Teaching and Learning on 1 October 2014 after Prof Schoeman retired earlier in the same year.

The Faculty's alignment with the University's strategy also resulted in some significant changes in its organisational structure. At the beginning of the period under review, the Faculty comprised four schools and ten departments: the School of Financial Sciences (the departments of Accounting, Auditing, Financial Management, and Taxation); the School of Economic Sciences (the Department of Economics); the School of Management Sciences (the departments of Business Management, Human Resource Management, Marketing and Communication Management, and Tourism Management); and the School of Public Management and Administration (SPMA), a department which functioned as an independent school.

Prof Carolina Koornhof | Dean, 2003–2011



Prof Elsabé Loots, Dean | 2012–2018 and beyond



the end of 2018, the Faculty contributed 18,4% of the total number of graduates produced by the University of Pretoria. At the beginning of the reporting period, EMS offered 22 undergraduate degrees but, in 2015, the Faculty started with a concerted effort to reduce the number of undergraduate degrees. By the end of 2018, the Faculty offered 18 undergraduate degrees.

The focus was on offering relevant programmes in an innovative teaching and learning environment, and on producing employable, innovative, and sought-after graduates. The EMS Faculty's teaching and learning model changed substantially during this period, and several forms of hybrid learning were introduced. A concerted effort was made to introduce more technology in teaching and learning and, in so doing, the Faculty succeeded in actively engaging students in the learning process, facilitated peer learning, and an enhanced learning experience. Introducing more technology also contributed to the goal to develop students who can adapt in the technology-rich world of work. The Faculty adopted, for example, e-tutoring and a flipped classroom approach where the traditional lecture and homework elements of a course were reversed by using YouTube videos to deliver course content. This model allowed for more interaction between students and lecturers and was successful. The Faculty also focused on promoting the professional conduct and ethical behaviour of students. To facilitate the latter, a set of conduct rules and a compulsory module on Business Ethics were developed. During this period, the EMS Faculty also initiated a comprehensive curriculum transformation project.

Improving throughput remained a priority. In this regard, a 'First Six Weeks Programme' — the name was later changed to *Phafoga* (wake up and be alert) — was introduced in 2013 where first-year students were monitored and supported during their first six weeks on campus. Further initiatives to strengthen throughput included the appointment of Faculty Student Advisors, and a generic first semester to enable easier articulation between degrees at the first-year level. In 2017, the Faculty introduced, for the first time, two test weeks for first-year students which further enhanced the positive impact of the generic first semester. EMS also supported and promoted the institutional initiative, Fly@UP.

The focus was on promoting diversity by changing the student and staff profile, ensuring accessibility and equal opportunities for all, and addressing the country's skills needs. In this regard, a particular highlight for the Faculty was the graduation of the first group of Thuthuka students (37) on 15 April 2010. The Thuthuka programme was implemented in

2007 with the purpose to increase the number of African and coloured chartered accountants and thereby contribute to the transformation of the profession.

In 2012, the EMS Faculty had its first intake of students in the foundation year programme presented on the Mamelodi Campus. This programme provided students who do not meet the minimum admission requirements for the standard undergraduate programmes — and those from disadvantaged backgrounds — the opportunity to gain access to tertiary education.

### Research and postgraduate education

During the review period the EMS Faculty continued to build on its reputation as a leading and preferred centre for postgraduate master's and doctoral studies, and its strong research and international profile. The Faculty successfully increased research capacity and the quality and quantity of outputs. In 2015, the Faculty recorded the highest number of accredited journal publications in its history with 139.64 journal outputs. During the same year, the Faculty also recorded the highest number of NRF B-rated researchers in the fields of economics, management, and financial sciences in the country. The number of NRF-rated staff grew from 11 in 2009 to 31 (including one A-rated and eight B-rated scientists) in 2018. Significant progress was also made in the improvement of staff qualifications. At the end of the reporting period, 46,4% of academics in the Faculty had completed their PhDs, and the remaining 43,6% held master's degrees as their highest qualification.

During the period under review, the Faculty identified and established a number of flagship research areas, viz: financial decision making and behavioural finance; accounting education; corporate transparency and consequences of reporting quality; consumer privacy, social media, relationship marketing and consumer decision making; entrepreneurship; cross-cultural studies and psychometrics; gender and diversity in organisations and work-life balance; strategic management and business rescue; tourism, travel and ecotourism; macroeconomics and microeconomics; development economics; environmental, resource, and energy economics; tax policy and governance; and communication and reputation management.

In support of the Faculty's goal to increase its research impact, these research focus areas were aligned with the QS Subject Rankings as well as with the global UN Sustainable Development Goals (SDGs).

The Faculty hosted several leading institutes, centres and research chairs, which included in the review period the following:

- African Tax Institute (ATI) — Prof Riël (RCD) Franzsen (2007)
- Albert Luthuli Centre for Responsible Leadership (ALCRL) — Prof Derick (D) de Jongh (2009)
- South African SDG Hub — Prof Willem (W) Fourie (2017)
- Unit for Forensic and Investigative Accounting — Danie (D) du Plessis/ Adv Hannes (H) Bezuidenhout (1999/2013)
- SARChI Research Chair in Tax Policy and Governance — Prof Riël Franzsen (2013)
- The South African Reserve Bank (SARB) Chair — Prof Nicola (N) Viegi (2010).

The EMS Faculty hosted and published the following journals:

- *South African Journal of Economic and Management Sciences* (SAJEMS), accredited by ISI
- *School of Public Management and Administration* (SPMA), accredited by IBSS
- *African Journal of Public Affairs* (AJPA), published under the auspices of the African Consortium of Public Administration (ACPA)
- *The Meditari* Accounting Journal
- *South African Journal for Entrepreneurship and Small Business Development*, an e-publication.

International research partnerships were actively pursued and EMS established several formal international agreements with leading institutions during the review period. These agreements resulted in valuable collaborative research and exchange opportunities for staff and students. By the end of 2018, the Faculty had active agreements with the following institutions:

- Louisiana State University, US
- Nanjing Audit University, China
- Fordham University, New York, US
- Tilburg University, the Netherlands
- Erasmus University, the Netherlands
- Georgia State University, US
- University of Oulu, Finland

While the EMS Faculty abolished the school system in 2009, it retained the existing structure of departments until 2014, when the departmental structure was again reviewed. The Department of Marketing and Communication Management was split into the Department of Marketing Management and the Division for Communication Management, now part of the Department of Business Management. The Department of Tourism Management was incorporated as a division into the Department of Marketing Management.

Departments and affiliated research entities are listed alphabetically in the text descriptions that follow below.

### Teaching and learning

The EMS Faculty continued to distinguish itself as a major role player in undergraduate and postgraduate education and made significant contributions to the social and economic advancement of the country. During the 2009 to 2018 period, EMS maintained undergraduate and postgraduate student numbers of approximately 8 500 students per annum. At

- Management Center Innsbruck and the Entrepreneurial School, Austria
- Vienna University of Economics and Business, Austria
- Eberswalde University for Sustainable Development, Germany
- Bournemouth University, UK
- Vorarlberg University of Applied Sciences, Austria
- University of Auvergne, France
- Göttingen University, Germany.

Especially towards the end of the reporting period, the EMS Faculty prioritised the quality of postgraduate studies. The focus was on shortening the completion times of master's and doctoral students, increasing the number of black and international postgraduate students, and on improving postgraduate administration processes.

### Curriculum transformation and accreditation

In 2010, the EMS Faculty took the strategic decision to keep undergraduate student numbers stable and gradually to increase postgraduate numbers. In 2013, and given that honours programmes were considered a valuable pipeline for master's and doctoral degree programmes, the Faculty took a further decision to equip honours students with foundational research skills. The Faculty also initiated postgraduate development programmes for staff and students, including the unique year-long learning programme established in 2017, designed to equip doctoral students with the resources to become scholars.

A number of new postgraduate degrees were initiated aimed specifically at addressing the needs of professionals and practitioners:

- 2009** PhD Industrial and Organisational Psychology
- 2010** MPhil Business Management Responsible Leadership  
PhD Taxation
- 2011** MPhil Strategic Management  
MPhil Business Management Supply Chain Management

- 2012** PhD Tax Policy  
PG Dip Integrated Reporting  
PG Dip Entrepreneurship
- 2013** BCom Financial Sciences  
BCom Hons Investment Management  
PhD Fraud Risk Management
- 2015** PhD Leadership  
MPhil Tourism Management
- 2017** PG Dip Accounting Sciences  
PG Dip Communication Management  
MPhil Development Practice  
PG Dip Tourism Management
- 2018** MPhil Public Policy

Other milestones during the period under review included the launch of the Mamelodi Business Clinic in 2010 with the purpose to facilitate entrepreneurship and small business development in the Mamelodi community. The clinic also created opportunities for service learning for students, and together with the University Business Incubator (UPBI), it became the community service flagship project of the EMS Faculty.

The focus was also on the quality of student life and building relationships with Faculty Student Houses. Forums such as 'EMS Engage' were implemented to facilitate interaction with students. The student house, House Commercii, provided opportunities for academic and leadership development and also facilitated outreach activities thereby creating social interaction to enrich students' campus experience.

The EMS Faculty continued to be recognised for producing outstanding graduates. During the period under review, the Faculty occupied either first or second place in the South African Institute for Chartered Accountants (SAICA) Initial Test of Competence (ITC) exams. Several students participated and achieved excellent results in national and international competitions. The Faculty was also recognised as one of just nine centres for internal audit excellence globally by the Institute of Internal Auditors.

A further tribute was that the Faculty maintained the accreditation of several of its qualifications by national and international bodies. These included:

Degree	Accreditation Body
BCom (Accounting Sciences) BCom (Financial Sciences) BCom (Investment Management)	Association of Chartered Certified Accountants
BCom (Accounting Sciences) PG Dip (Accounting Sciences)	South African Institute of Chartered Accountants
BCom (Investment Management)	CFA Institute University Affiliation Programme
BCom (Financial Sciences) BCom Honours (Financial Sciences)	Chartered Institute of Management Accountants
BCom Honours (Taxation)	South African Institute of Tax Professionals
BCom (Supply Chain Management)	European Logistics Association
BCom (HR Management) BCom Honours (HR Management and Labour Relations) MCom (HR Management) MPhil (HR Management) MPhil (Labour Relations Management)	South African Board of People Practitioners
MCom (Industrial and Organisational Psychology)	Health Professions Council for South Africa

### Notable events and recognition

There were several notable achievements during the review period. In 2017, the EMS Faculty became a member of the Association to Advance Collegiate Schools of Business (AACSB) International; and in 2018, received eligibility status from the AACSB, an important milestone on the accreditation path.

The Faculty increased its global competitiveness and recognition, as demonstrated in the Quacquarelli Symonds (QS) Subject Rankings. At the end of the period under review, Economics was ranked in the 251–300 band (2nd in South Africa), with Accounting and Finance in the 151–200 band (ranked first in South Africa).

The Faculty celebrated its 90th and 95th years of existence in the review period. The Department of Marketing Management celebrated its 40th anniversary in 2010, and the Department of Taxation and the African Tax Institute (ATI) respectively celebrated their tenth anniversaries in 2017.

Notable events for the EMS Faculty included:

- The launch of the Anton Rupert Memorial Lecture series (2008).
- The launch of the book, *Courageous Conversations*<sup>1</sup> (2010).
- The first global Conference on Responsible Leadership (2014), and the continuation of this theme in two further conferences (2017 and 2018).
- A workshop on risk management presented by the internationally renowned Dr Andries (A) Terblanche (2010), and a keynote address by Judge Bernard (BM) Ngoepe from the Office of the Tax Ombud (2015).

Several well-known South Africans were recognised through honorary doctorates. These included: Prof Stephan (SG) Hall, DCom (April 2010), Prof Peter (PH) Pauly, DCom (September 2010), Dr Christopher (CF) Patten, DCom (March 2011), Prof Solomon (SJ) Terreblanche, DCom (April 2012).

During the period under review, several EMS staff and students received prestigious national and international recognition and awards. The detail is presented under the respective departments.

### Performance in overview

There were areas of exceptional achievement during the period 2009 to 2018, as highlighted in this overview, and in department and research entity texts. The [performance at a glance](#), presented below (see pages 111 and 112) provides further detail.

Notable performance achievements included:

- The growth in postgraduate enrolment and diversity with numbers peaking between 2011 and 2013 and slightly decreasing by 2018. In the same period, there was an increase in the percentage of black postgraduate students who enrolled in EMS programmes — from 45,8% in 2009 to 60,2% in 2018; and in the percentage of master's and doctoral students enrolled — from 52,4% in 2009 to 64,1% in 2018.
- The changing profile in black undergraduate enrolment showed a positive trend in line with the EMS strategy — from 47,2% in 2009 to 58,2% in 2018; and in the percentage of black undergraduate students who graduated, from 43,4% in 2009 to 52,0% in 2018.
- The overall success rate of all undergraduate students is also reflected in the module pass rate that improved from 72,6% in 2010 to 80,0% in 2018. Measured as a percentage

<sup>1</sup> D Gleason, S Nkomo and D de Jongh. 2011. *Courageous Conversations*, First Edition, Van Schaik Publishers.

of successful FTE students to total FTE enrolments, the increase was from 80,2% in 2012 to 83,4% by 2018.

- EMS established the University as national leader in the training of chartered accountants with an average pass rate of 94% during the reporting period.
- Strengthened staff and supervisory capacity is reflected in the number of staff who achieved NRF ratings — from 11 in 2009 to 36 in 2018, and in the percentage of staff with PhDs which increased from 30,2% to 46,7% over the same period.
- Industry involvement was expanded in the departments of Marketing Management, Business Management, Auditing and Taxation, which strengthened student's experience. Industry bodies recognised the exceptional performance of especially the departments of Human Resource Management and Financial Management.
- Since 2016, subject areas were listed on a number of world-ranking tables which was evidence of the improvement in the quality and quantity research, the quality and employability of EMS students and international recognition.
- A noteworthy achievement was the increase in the weighted M and D graduate output per academic FTE staff increased, from 0,35 to 1,41 over the same period, and journal unit outputs from 79,7 in 2009 to 131,6 in 2018.



Prof Stella Nkomo and Prof Elsabé Loots

As noted at the outset, the strategic direction and consistent achievements on a number of levels show that the EMS Faculty had strengthened its academic identity and impact during the review period. As in the past, this decade was influenced not only by the particular challenges and events in the national and international environments, but also by modifications and revisions in the EMS degree offerings and programme structures. For the Faculty to remain aligned with the latest trends and expectations of all stakeholders demanded the commitment and agility of all staff. The important roles fulfilled by current and former heads of department, academic and professional staff during this particular reporting period, are acknowledged.

**Prof Elsabé Loots** | Dean, 2012-2018 and beyond

## EMS: PERFORMANCE AT A GLANCE

### Enrolment and success

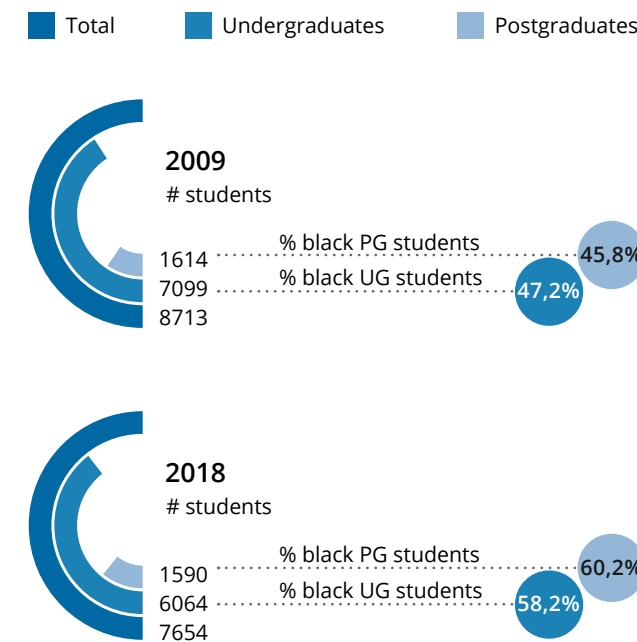

### Undergraduate module pass %

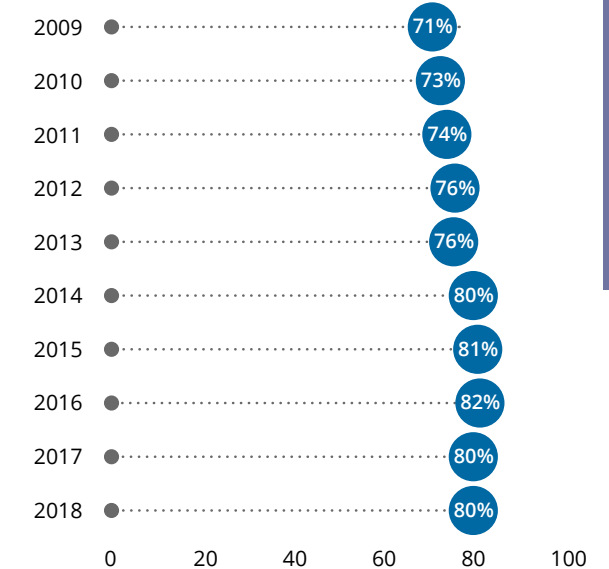

### Research pipeline

#### M and D enrolment

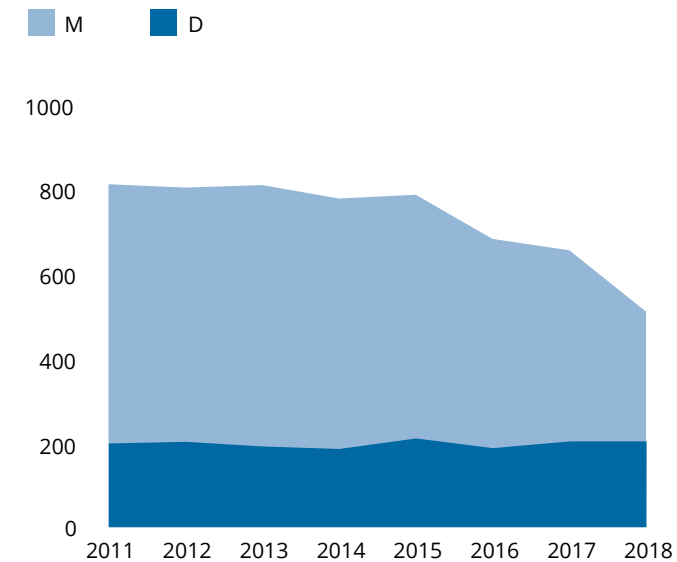

#### M and D graduates

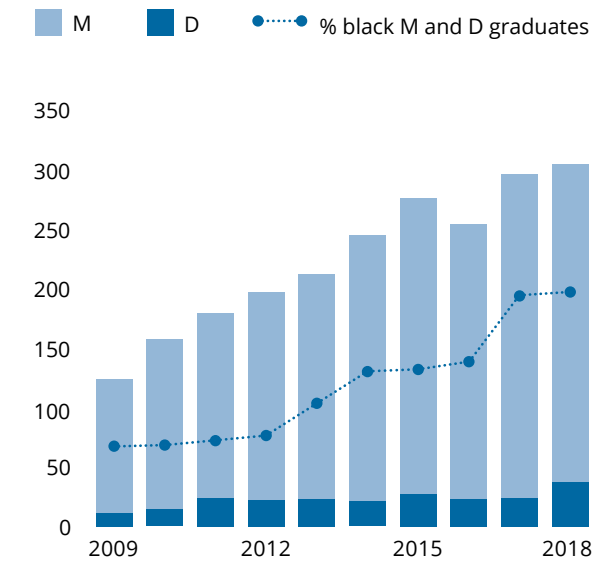

### UG graduates

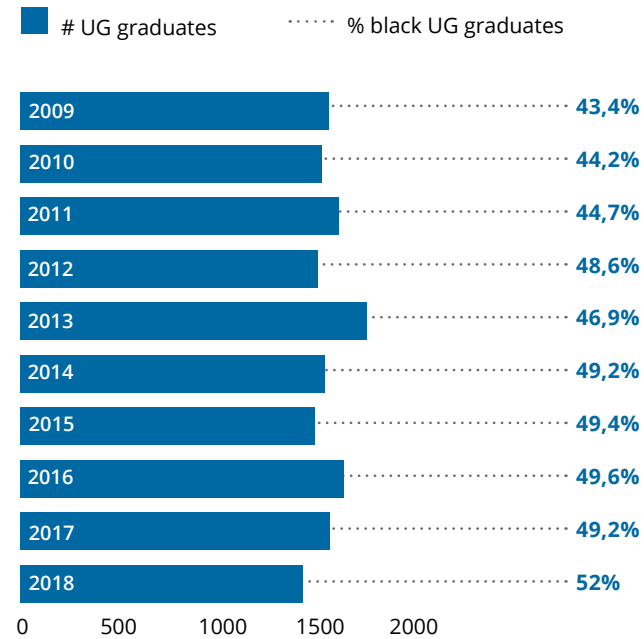

### Student : staff ratio

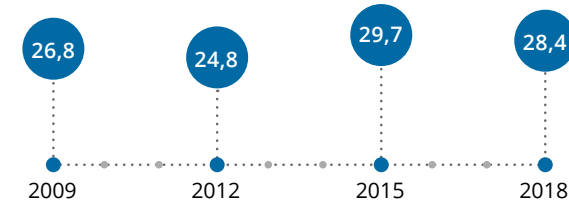

### Weighted M and D output

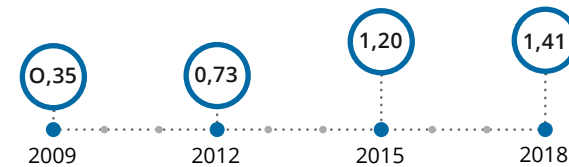

### Capacity and productivity

#### % Academic staff with PhDs

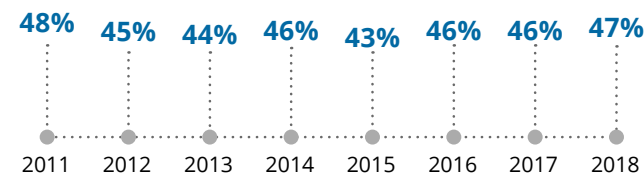

#### NRF-rated researchers, 2018



#### Research output

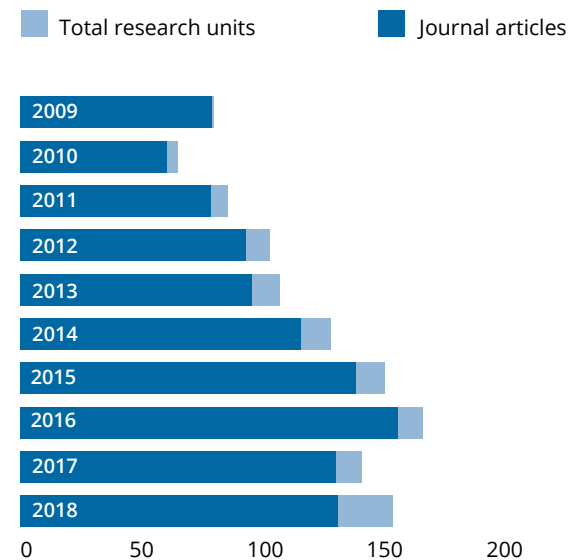

## DEPARTMENTS

### 1. Accounting

Prof Quintus (Q) Vorster served as Head of the Department of Accounting for two periods, from 1993 to 2001, and again from 2007 until his appointment, in 2009, as UP's Director of Finance. He was succeeded by Prof Johan (JGI) Oberholster in June 2009 who served in this leadership position until February 2013. When Prof Oberholster was appointed as the first Chartered Accountant (CA) Programme Coordinator in March 2013, Prof Jean (JE) Myburgh served in an acting capacity as Head of Department until December 2015. Prof Madeleine (M) Stiglingh was appointed as the new Head of the Department, from January 2016, and remained in this leadership position beyond the review period.

The Department of Accounting was responsible for the BCom (Accounting Sciences), BComHons (Accounting Sciences), and the PhD (Accounting Sciences) degrees, and for the qualifications offered by the Unit for Forensic and Investigative Accounting. An MCom programme in Accounting Sciences, developed with the input of eminent visiting international scholars, was introduced in 2009. In 2016, this two-year programme was restructured into a one-year MCom programme. In 2012, the Unit for Forensic and Investigative Accounting was transferred to the Department of Auditing. In 2017, in compliance with the Higher Education Qualifications Framework (HEQF) requirements, the BComHons (Accounting Sciences) degree was changed to a postgraduate diploma, namely PGDip (Accounting Sciences).

#### Highlights of achievement

In April 2010, the first 37 UP Thuthuka students graduated with a BCom (Accounting Sciences) degree, and a year later, in April 2011, the first cohort of 21 students received their BComHons (Accounting Sciences) qualification. A further accolade was that the top UP Thuthuka student of 2016, Azile Nkabinde, was also the first ever Thuthuka student in the country to secure a position in the South African Institute of Chartered Accountants' (SAICA) Initial Test of Competence (ITC) Top Ten candidates, where she was placed fourth out of 2 561 students. She was one of only six students who passed the 2017 national exam with distinction.

During the review period, the Department taught, on average, 5 500 students per annum (3 800 students in service modules and 1 800 students in the CA programme). The number of undergraduate students who graduated were around 350 students annually, with a spike to above 450 students in 2016 and 2017 respectively. The number of UP students eligible to write the ITC was 131 in 2009, and gradually increased to 210 in 2018. The excellent reputation of the CA programme was further confirmed by the fact the UP had an average January ITC pass rate of 94% during the period under review. When the results of the January and June ICTs are combined, UP held the number one position in the ITC exams in the country in 2017 and 2018.

Two teams received the highest level of teaching excellence recognition at UP's annual Academic Achievers' Awards, in 2016 and 2017 respectively — the Laureate Award for Teaching and Learning Excellence:

- In 2016, the recipients were Prof Stephen (SA) Coetzee and Astrid (A) Schmulian, in recognition of their introduction of framework-based teaching in Accounting and their pioneering work in 'flipped classroom' teaching at UP. In the same year they also received the highest recognition for teaching and learning excellence in South Africa, namely the Council on Higher Education (CHE) and the Higher Education Learning and Teaching Association of Southern Africa (HELTASA) award for Excellence in Teaching and Learning. International recognition for their outstanding innovations was also received in their selection as a finalist for the international Quacquarelli Symonds (QS) Re-Imagine Education awards in 2016 and 2017.
- The recipients of the UP Laureate Award for Teaching and Learning Excellence in 2017 were Corlia (C) Joynt and Madelyn (M) Cloete. The project for which they received the award can best be described as a milestone in their journey towards the evolution of an Accounting educational experience through the development and implementation of a hybrid model for first-year accounting students. The development of their multi-lingual glossary reached a high point with the finalisation of a mobile app to make the information readily available to students.





## Research

The increased research focus of the Department reaped benefits in 2014, when an extraordinary professor in the Department, Prof Charl (CJ) de Villiers, received an NRF C1 rating. This was followed in 2016 by Prof Elmar (ER) Venter who received an Y1 rating, and in 2018, by Prof Stephen Coetzee who received a C1 rating.

Since 2017, Accounting and Finance had been ranked in the 151–200 group on the QS World Subject Rankings. In the same year, UP was ranked third out of 252 institutions on the Brigham Young University Accounting Education Research rankings.

It is also worth highlighting that, since the late 2000s, *Meditari*, the journal established in 1993 in the Department of Accounting, had been published by Emerald Group. It is included in international journal indexes and in different world rankings, namely the Australian Business Deans Council (ABDC) and the Scopus CiteScore ranking, and the SCIMago journal rank indicators for Accounting journals.

## 2. Auditing

### Leadership and strategy

Prof Herman (H) de Jager was the Head of the Department of Auditing at the beginning of the period under review until his retirement in June 2012. He was succeeded by Prof Karin (K) Barac in July 2012 who was reappointed for a second term in 2016.

During the period under review, the programmes offered by the Department of Auditing focused on three areas: external auditing, internal auditing, and forensic and investigative accounting. The undergraduate and postgraduate programmes in internal auditing were accredited by the Institute of Internal Auditors (IIA) Global as a Centre for Internal Auditing Excellence, the IIA's highest level of educational expertise. UP's internal auditing programme was one of only eight such programmes recognised at this level in the world. The programme enjoyed many ties with both the IIA Global and IIA South Africa in that the programme's lecturers represented the University on local, national and international committees, and played an active role in promoting all aspects of internal auditing education.

## Highlights of achievement and impact

In May 2017, Rudrik (R) du Bruyn, a senior lecturer in the Department, was appointed as the chairperson of the IIA Global Academic Relations Committee. He was the first South African to hold this office. The Committee provides guidance at a global level on academic programmes and internal audit education. Dr Kato (K) Plant, another senior lecturer in the Department, was recognised by the Institute of Internal Auditors South Africa (IIA SA) as the Educator of the Year at a national award function in August 2016. She was acknowledged for her continuous involvement in educating internal audit professionals and, particularly, for the valuable contribution made by her PhD study, titled 'A workplace learning framework for developing entry-level internal audit professionals,' which had already informed the profession's training practices.

The Department's internal audit offerings were overseen by an Advisory Board that drew its membership from the ranks of senior representatives of the IIA SA, public practice, commerce and industry, and government. The Advisory Board, among others, ensured that the programme addressed the best interests of the internal audit profession, and that the interests of the students were continuously served. This was achieved by involving practising internal auditors in the education process of students, and by ensuring that students gained practical exposure in the form of internships. In addition, the Advisory Board advised on any amendments to the curriculum of programmes and modules, and monitored the Department's overall ethos. The Department's centre of excellence status not only ensured that UP's Internal Auditing programme was held in high esteem, but also that its graduates were in high demand in commerce, industry, academia and government. In addition, a memorandum of co-operation between UP and the Nanjing Audit University in China, both accredited by the IIA Global as Internal Auditing Education Partnership (IAEP) schools, continued during the review period and more than 60 students and eight staff members participated in exchange activities during this time.

The Department's external auditing modules at both undergraduate and postgraduate levels prepare students for the external audit profession. Staff involved in the chartered accountancy (CA) programme, accredited by the South African Institute of Chartered Accountants (SAICA), had received a number of teaching awards from the EMS Faculty for innovative teaching and learning practices and active student engagement.



## Research

A research team drawn from the Department's external auditing staff complement, with Prof Barac as the principal investigator, investigated the future parameters of the SAICA and the Independent Regulatory Board for Auditors in South Africa (IRBA) competency frameworks. This research was not only critical for the development of future chartered accountants and auditors, but would impact on their education and training models, and shape the industry's future reporting and assurance guidelines. These would

directly and indirectly influence the direction of South Africa's economic and social development. A further area of research was the development of the professional and ethics competence of auditors for the future world of work and workplace learning practices. During the review period, this involved the Department's staff and postgraduate students enrolled for the MPhil in Internal Auditing, and the MCom and PhD degrees in Auditing.

The Unit for Forensic and Investigative Accounting (established in 1999), originally in the Department of Accounting, moved to the Department of Auditing in May 2012. The reason for the Unit's placement in the Department of Auditing was to streamline postgraduate supervision and to further enhance interdisciplinary research between the Department and the Unit. The Unit was managed by Danie (D) du Plessis until his retirement in July 2013. He was succeeded by Adv Hannes (H) Bezuidenhout in August 2013.

In addition to its well-deserved reputation as the provider of an excellent academic programme, offering a postgraduate diploma in forensic and investigate accounting and a MPhil in fraud risk management, this Unit was also involved in activities focused on enhancing the education and training of both full-time students and those already in public and private practice. During the review period some of these activities included short courses in the fields of fraud, risk management and forensic accounting. These short courses contributed directly to the development of the skills needed to combat fraud and corruption in a country where this scourge had reached endemic proportions.

### 3. Business Management

#### Leadership and change

Prof Giel (GH) Nieman was the Head of the Department of Business Management at the start of the review period and remained in this position until 2012. Prof Anské (AF) Grobler was appointed as the new Head of Department in 2013, the first woman to be appointed in this leadership position since 1927. Prof Grobler aligned the Department rapidly to adapt to the research intensive focus of the University of Pretoria. Prof Alex (AJ) Antonites took over the leadership role in April 2017. His focus was on building a strategic cohort approach and a departmental structure in alignment with the Faculty and UP's strategic intent, namely a strategy that consolidates areas of strength under thematic fields of relevance.

#### Highlights of innovation

An innovation driven approach advanced the Department of Business Management on many levels. The following were some of the highlights:

In 2014, Prof Alex Antonites, Dawie (D) Bornman, Reba (RG) Letsholo and Wesley (W) Rosslyn-Smith received the UP Excellence in Teaching Award for a unique 'flipped classroom' method, which was a significant recognition for innovation in practice.

Business Management streamlined its undergraduate offering in 2017 by introducing a contemporary approach in the global managerial sciences by integrating entrepreneurship, business management and responsible leadership in one BCom programme. This new programme with a strong emphasis on ethical leadership principles started in 2018 and provided students the opportunity to become employable and self-employed. Named the BCom (Business Management) degree, the programme also included new modules that prepared students for a 4IR mindset (e.g., design thinking and innovation, business creation, business analytics, and responsible management and leadership).

The Department's thematic focus on supply chain management was a significant contribution to developing work-ready students for a changing work environment. The growth in this field also involved the first memorandum of understanding with the Chartered Institute of Purchasing and Supply in 2012. A specialised MPhil Supply Chain Management followed in 2014. The BCom (Supply Chain Management) programme received the prestigious European Logistics Accreditation (ELA) in 2017, which positioned the qualification on the global map. The BComHons (Supply Chain Management) commenced in 2018, thereby completing a comprehensive suite of qualifications in this field.

Under the umbrella of entrepreneurship, the Department introduced a new postgraduate diploma, the PGDip (Entrepreneurship) in 2018, with the main focus on enabling students to either start a new or manage an existing business while they study.

The Department's strategic management focus commenced in 2016 with the introduction of an MPhil degree with specialisation in strategy and leadership, with the planned restructuring of this degree to follow in 2019 by focusing on business strategy and international management.

The Division Communication Management merged with the Department in 2018 and communication management became the fourth focus area in the Department of Business Management.

#### Research

The Department of Business Management grew its scientific research output from 2.63 units in 2009 to 23.4 units in 2018. The transformation of the research component in master's programmes into research papers elevated research outcomes, coupled with the increased enrolment of master's and doctoral students. Between 2012 and 2018 alone, 47 doctoral and 279 master's students graduated.

Four staff members received NRF ratings during the review period: Prof Jurie (JJ) van Vuuren (C2), Prof Marius (M) Pretorius (C2), Prof Sonali (S) Das (C3), and Prof Willem (W) Fourie (Y2). By 2018, over 50% of staff held PhD qualifications.

International collaboration formed a key strategic driver in the Department's thematic foci. To illustrate, the following were some of the formal relationships established during the review period:

- In 2017, a cooperation agreement with KU Leuven University, Belgium was signed for the development of a joint doctoral programme in entrepreneurship with a focus on social entrepreneurship.
- Also in 2017, a memorandum of cooperation with Georgia State University (US) was signed on student and staff exchanges.
- In 2018, collaboration with the Leadership Excellence Institute Zeppelin (LEIZ) at Zeppelin University (Germany) was formalised and would involve a number of projects.

Finally, at the level of action research and engagement, the Mamelodi Business Clinic was established by the Department in 2011 and became a key role-player in the implementation of community development initiatives.



### Albert Luthuli Centre for Responsible Leadership

The Centre for Responsible Leadership was established in 2009 in the EMS Faculty, and linked to the Department of Business Management, with Prof Derick (D) de Jongh appointed as the founding director. In 2011 the name changed to the Albert Luthuli Centre for Responsible Leadership (ALCRL). Prof De Jongh remained in this leadership position during the review period.

Its vision — ‘Leaders for good’ — seeks to develop the next generation of responsible leaders in support of social and environmental justice. Its broad mandate has included inter- and trans-disciplinary research, spanning boundaries between academic disciplines and faculty borders. Research, teaching and engagement uses novel and emerging approaches to leadership to address pressing social, environmental and economic challenges.

The ALCRL’s legitimacy lies in its ability to respond to key issues in the field of corporate responsibility and responsible leadership. Its relevance is determined by the extent to which stakeholders — internal (UP academics and students) and external (private sector, public sector and civil society), put a premium on the ALCRL’s ability to advance responsible leadership through relevant teaching and research interventions.

During the review period, the ALCRL introduced four new qualifications, the first three in 2013 and 2014, and the fourth in 2018:

A Postgraduate Diploma in Integrated Reporting (PGDIR). The PGDIR programme adopted a multidisciplinary approach in preparing students for the multi-faceted challenges that integrated reporting aims to address. It also encourages students to think broadly when contemplating these challenges.

An MPhil in Responsible Leadership. The MPhil (Responsible Leadership) constitutes a multidisciplinary programme with a focus on creating leaders that strive for a sustainable future.

A PhD in Leadership. This programme aims to pursue scholarship that reimagines leadership towards social, environmental and economic justice.

An MPhil in Development Practice. The MDP is a multidisciplinary postgraduate qualification that focuses on leadership in the implementation of the UN Sustainable Development Goals (SDGs). The one-year master’s programme uses a hybrid learning approach, and focuses on the social sciences, health sciences, management sciences and natural sciences. The MDP is presented in collaboration with the Global MDP Secretariat, based at Columbia University in New York (US).

In addition, in 2018 the ALCRL engaged all first-year EMS students on the role and impact of the SDGs. The ALCRL developed two pioneering modules that were included in the mainstream BCom (Business Management) degree, namely responsible management and responsible leadership.

Between 2012 and 2018 the ALCRL hosted five international conferences on leadership bringing scholars from across the globe to present their latest research in the field of leadership studies.

### South African SDG Hub

The South African SDG Hub, under the leadership of Prof Willem (W) Fourie, was established in 2017. The SDG Hub has worked with universities in South Africa and on the continent to source research publications that can inform policies in support of development. It is run by a small group of young researchers who have contributed to the development of a website that has made the accessibility of science and translational research a reality. Prof Fourie and colleagues have also assisted the South African government in preparing its SDG reports for submission to the United Nations.



## 4. Economics

### Leadership and strategy

Prof Steven (SF) Koch, previously a professor in the Department of Economics, was appointed as the new Head of Department in November 2009, after Prof Jan (JH) van Heerden stepped down earlier in that year. In 2013, Prof Koch was reappointed for a second term, and in 2017 for a third term.

During the review period, and under the leadership of Prof Koch, the Department of Economics revised its undergraduate and postgraduate programmes with a focus on the underlying skills needed by competent economics students. The Department also set out to simplify its offerings and to strengthen its staff complement in core economic fields in order to strengthen its programmes and research.

In 2010, Prof Nicola (N) Viegi was appointed as the new South African Reserve Bank Chair in Monetary Economics. Prof Viegi, along with a number of internationally trained African macroeconomists, established the Department's international position as a leader in Macroeconomics, especially micro-founded Macroeconomics. That position was further strengthened by the Department's renewed focus on Microeconomics. During the period under review, the Department hired a number of international and South African microeconomic staff who had completed their training at top international institutions.

### Curriculum change

During the time under review, as well as many decades before, the Department of Economics continued to deepen its roots in Mathematics and Statistics, and in the Social Sciences (Psychology and Political Science, to name the most prominent). Thus, the undergraduate programmes in both Economics and Econometrics more clearly required mathematics and statistics skills, with the econometrics programmes requiring more depth in Mathematical Statistics.

For the postgraduate programmes, effort was put into developing the strength of the Department's core offering, the PhD. The degree was realigned to match international norms. The Department reconfigured its MPhil programme to become a pre-PhD degree, which led to additional changes in the remaining MCom programmes. In addition to those changes, it was deemed necessary to put the DCom degree, which was not generally available internationally,

on hold while also removing doctoral programmes in Econometrics. Internationally, Econometrics is viewed as a field of Economics. Furthermore, at the PhD level, it is largely theoretical. Although the Department had always offered and continued to offer econometrics modules at the postgraduate level, such modules focused on previously developed theory and application, rather than on the development of new theoretical insights and models. The Department's decision was to focus its attention more clearly on Economics.

### Highlights and achievements

There were several highlights during the period under review, some of which are listed here to illustrate achievements of individuals and of the Department.

The following were noteworthy conferences and symposiums:

- UP hosted 300 leading international economists who explored a raft of public policy and development issues at the 65th congress of the International Institute of Public Finance (IIPF). The congress took place at the Cape Town Convention Centre from 13 to 16 August 2009.
- In 2011, the African Tax Institute (ATI), situated in the Department of Economics, and the Lincoln Institute of Land Policy, based in Cambridge, Massachusetts in the United States, co-hosted a workshop on Property Taxation in Africa.
- In the same year, the Department of Economics, the South African Reserve Bank and Economic Research Southern Africa (ERSA) jointly hosted a workshop on monetary economics and macroeconomic modelling from 10 to 11 March 2011.
- In June 2016, the Department of Economics hosted the 2016 Africa Meeting of the Econometric Society at the Kruger Park Lodge. The conference, fully organised by the Department, included academic participants from nearly 60 countries. Keynote speakers included Eddie Dekel (Northwestern University and Tel Aviv University), the President of the Econometric Society, Sir Richard Blundell (University College London), and Stephen Turnovsky (Washington University).

Individual recognition and awards included:

- In 2009, Prof Rangan (R) Gupta, was listed as one of the top 100 young economists on the RepoSitory of Economics; and in 2013, he was ranked 16th on the list of the top 200 young economists of Research Papers in Economics (RePEc).

- Prof Gupta was one of the founder members of the South African Young Academy of Science (SAYAS). SAYAS was launched in September 2011 after an incubation process that was supported by the Department of Science and Technology (DST) and the Academy of Science for South Africa (ASSAf).
- In 2013, Prof Koch was appointed as the managing editor of the *South African Journal of Economics*.
- Prof Roula (R) Inglesi-Lotz, an associate professor in the Department of Economics, received the Exceptional Young Academic Achiever Award at the annual UP Academic Achievers' Awards ceremony, held on 14 May 2013.
- Prof Inglesi-Lotz was among nine new SAYAS members inaugurated at the annual ASSAf awards ceremony on 11 October 2017. Also in 2017, Prof Inglesi-Lotz was named the Distinguished Young Woman Researcher in the Humanities and Social Sciences category at the annual Department of Science and Technology (DST) Women in Science Awards. The awards recognise the achievements of prominent women scientists and provide motivation

for the increased participation of women scientists in research.

- In 2017, Prof Alexander (A) Zimper received the UP Exceptional Academic Achiever Award.

At the start of the review period, an article in the *South African Journal of Economics* showed that the Department of Economics at the University of Pretoria had improved its ranking from the fourth to the second position in South Africa. In addition, the Department was considered by far the most efficient in the country in terms of student: staff ratios and research articles published.<sup>2</sup> This relative academic standing was further endorsed in a Thompson Reuters InCites comparison in 2016 which ranked UP the top African institution in the research area of Economics and Business, based on citations and the number of Web of Science (WoS) documents in the period 2012–2014. In the same InCites analysis, Prof Gupta was ranked the top African researcher. The QS Subject Rankings, released in 2018, placed Economics and Econometrics in the 301–350 band, thus within the top 2% worldwide.

<sup>2</sup> John M Luiz. 2009. Evaluating the performance of South African Economics Departments. *South African Journal of Economics*, November 2009. <https://doi.org/10.1111/j.1813-6982.2009.01228.x>



### The African Tax Institute

The African Tax Institute (ATI) was established in 2007 with Prof Riël (R) Franzsen as the founding director. Since 2013, he was also the incumbent of the SARChI Chair in Tax Policy and Governance.

Focusing on the public sector in Africa, the ATI remained devoted to education and research in the areas of tax policy and tax administration. The main goal of the ATI was to develop capacity in ministries of finance and revenue authorities. Towards this goal, the ATI commenced with an interdisciplinary master's programme in 2009. Between 2009 and 2018, more than 80 master's students and 13 doctoral students graduated, including four SARChI students. From 2018, the MCom (Taxation) and LLM Tax Law students were also accepted as SARChI students.

The research areas of ATI staff and students included tax policy, international taxation, natural resource taxation, value-added tax, fiscal decentralisation and property taxation.

The ATI maintained an extensive research collaboration network. First and foremost was its multi-year engagement with the Lincoln Institute of Land Policy (based in Cambridge, Massachusetts, United States). In 2017, the scholarly book, *Property Tax in Africa – Status, Challenges, and Prospects*, was published by the Lincoln Institute. Edited by Riël Franzsen and William McCluskey, the book provided the first comprehensive overview of property tax systems in Africa, including an overview of the policy and administrative issues regarding recurrent property taxes. As a result of this book, the ATI also became involved in a further scholarly book in 2018, *Property Tax in Asia – Policy and Practice*, which was anticipated to be published in 2022.

The ATI collaborated with the International Centre for Tax and Development (ICTD) at Sussex University (United Kingdom) on its Africa Property Tax Initiative. An outcome of this collaboration was a working paper published by the ICTD:

McCluskey W, Franzsen R, Kabinga M & Kasese, C. 2018. 'The role of Information Communication Technology to Enhance Property Tax Revenue in Africa: A Tale of Four Cities in Three Countries.'

The collaboration with the Vienna University of Economics and Business (WU) in Austria on good tax governance in Africa resulted in the book published by Pretoria University Law Press:

Owens J, McDonell R, Franzsen R, Amos J (eds.) .2017. *Inter-agency Cooperation and Good Tax Governance in Africa*.

The ATI also collaborated with Georgia State University (US), Masaryk University (Czech Republic) and Norad (Norway). Its collaboration with Norad, in particular, resulted in a research paper published:

Ngwenya L. April 2018. International tax agreements and domestic resource mobilisation: Norway's treaty network with low-income countries in Africa. NORAD research paper. ISBN: 978-82-8369-057-6.

In 2018, the ATI Working Paper Series was launched with eight working papers published in that year.

### South African Reserve Bank Chair in Monetary Policy

The South African Reserve Bank (SARB) Chair in Monetary Economics was instituted in 2007 to promote advanced teaching and research in monetary economics. Prof Eric (E) Schaling was appointed as the first incumbent of the Chair, and after his resignation in 2010, he was succeeded by Prof Nicola (N) Viegi. Under Prof Viegi's leadership, the agreement between the University of Pretoria and the South African Reserve Bank (SARB) was renewed three times with a total value of R6,5 million within the reporting period.

The focus also shifted slightly with greater emphasis given to research promotion, research collaboration, and the supervision of student research at honours, master's, and PhD levels. The Chair was working closely with the research department at the SARB to identify research themes relevant to national policymaking, to organise annual national workshops on monetary economics and macroeconomic modelling, and to supervise student research.

The SARB Chair in Monetary Economics made a positive and essential contribution to the country's macroeconomic research and the research foundations of policymaking in South Africa.

Between 2009 and 2018, 25 master's and ten doctoral students graduated. A further accolade was Prof Viegi and his PhD student Haakon (HN) Kavli receiving the award for the Best Paper in Macroeconomics at the Economic Society of South Africa (ESSA) conference held in September 2015. The paper entitled 'Portfolio flows in a two-country DSGE model with financial intermediaries' presented a model to illustrate the effect of global capital flows on a small emerging economy and to help identify the policy options available to an emerging market policymaker.

## 5. Financial Management

### Leadership

At the start of the review period, Prof Ebo (E) Oost was the Head of the Department of Financial Management. He stepped down in 2010 after nine years in this position and, in September 2010, was succeeded by Prof Henco (CH) van Schalkwyk who was re-appointed for a second term in September 2014. Prof John (JH) Hall was appointed to this leadership position in September 2018 as the new Head of Financial Management.

During the period under review, five staff members completed their doctoral qualifications: Prof Van Schalkwyk (2012), Dr Braam (GA) Lowies (2013), Prof Elda (E) du Toit (2013), Dr Michelle (M) Reyers (2014) and Dr Elbie (E) Louw (2016). By the end of 2018, all academic staff in the Department held, at minimum, a master's qualification. Between 2015 to 2018, ten PhD students graduated at an average completion time of 3.8 years. Measures were put in place to reduce the completion time even further.

Two of the Department's senior researchers were the first in Financial Sciences at UP to be NRF-rated, with both receiving C3 ratings — Prof Daan (DG) Gouws (2012), and Prof Hall (2015).

### Qualification and programme changes

There were a number of qualification and programme changes during the review period:

- In 2011/2012, the BCom (Financial Management Sciences) qualification was renamed BCom (Financial Sciences) and the programme reconfigured to incorporate aspects of the previous BCom (Internal Auditing) and BCom (Taxation) degrees. The new programme was offered from 2013.
- A research report was introduced in the BComHons (Financial Management Sciences) and the BComHons (Investment Management) programmes, and both were restructured to comprise four core year modules. The new programmes were offered from 2013.
- The MPhil (Financial Management Sciences) programme was reactivated and offered as a full research master's programme from 2016.

In 2017, the CFA Institute Partner Program (US) changed to the CFA University Affiliation Program and the Department successfully transitioned its BCom (Investment Management) degree to this new programme. To qualify, a degree programme must cover at least 70 percent of the body of knowledge of the Level 1 CFA Program and meet the CFA Institute's ethical and professional standards, in addition to other requirements.

## Highlights of achievement and events

Students of the Department of Financial Management performed well at national and international levels. To illustrate, final year students competed in the international Chief Financial Officer (CFO) Case Study Competition from 2016 to 2018, organised by CharterQuest. In the 2018 competition, the UP team was placed second in the international finals. Since its inception in 2009, students had also competed in the Chartered Financial Analyst (CFA) Institute Research Challenge, hosted by CFA South Africa. In 2011, the UP team won the national leg of the challenge. The team went on to represent South Africa in the Europe, Middle-East and Africa (EMEA) regional competition in London where they competed against 24 other teams.

In 2016, the Department hosted Nicky Newton-King, CEO of the Johannesburg Stock Exchange (JSE) as part of the Faculty's EMS Talk Series. Ms Newton-King engaged students and staff on topics ranging from the rationale behind insider trading regulations to trends in listings on both the JSE Main Board as well as AltX.

Several CFA charter holder staff members were, and remained, actively involved as volunteers for the CFA Institute as graders, standard setters, curriculum developers, and question writers. Dr Elbie (E) Louw, a senior lecturer in the Department, served on the board of CFA South Africa from 2007 to 2011, and as president for the 2010/2011 term.

The Department also contributed to the important Corporate Finance, Strategy and Management Accounting components to the South African Institute of Chartered Accountants (SAICA) exams. Over the review period, UP delivered consistent results with pass rates well above 90% in the Initial Test of Competence (ITC) (formerly the Qualifying Exam 1).

## Research

A paper presented by Prof Van Schalkwyk at the 23rd annual Southern African Finance Association (SAFA) conference held in January 2013 won the Alexander Forbes prize for the best research relating to investment management or behavioural research on retirement fund members' decision-making. The paper presented by Dr Reyers, at the same conference, received a special mention for promising research in the aforementioned area. Dr Reyers was also recognised for her publication in a highly ranked international journal in her field, and was the co-winner of the award in the category Best Junior Researcher of the Year in the Financial Sciences in 2015.

The Department received the EMS Faculty Award for the Most Improved Research Outputs by a Department in 2015 with respect to both the quantity and the quality of research outputs. Prof John (JH) Hall received the EMS award for the Best Senior Researcher of the Year in the Financial Sciences category in 2016 and 2017, and was the runner-up in 2018.

## 6. Human Resource Management

### Leadership and strategy

Prof Karel (KJ) Stanz was the Head of the Department of Human Resource Management at the start of the review period and remained in this position until 2016. He was succeeded by Prof Alewyn (JA) Nel who was appointed in April 2017 after serving in an acting capacity for a brief period.

During the period under review, the Department aligned its activities in support of its goal to be a leading and reputable academic department, providing contemporary scholarship and professional relevance in the fields of Industrial and Organisational Psychology (IPS), Human Resource Management (HRM) and Labour Relations (LR).

By the end of 2018, 90% of academic staff members had a PhD. Seven staff members were NRF-rated: Profs Stella (SM) Nkomo (A2), Jenny (JM) Hoobler (B3), Arien (C) Strasheim (C2), Deon (D) Meiring (C3), Pieter (P) Schaap (C3), Alewyn Nel and Eileen (FE) Koekemoer (both Y2-rated). This profile contributed to strengthening research capacity and increased output, especially in high impact journals.

### Highlights of achievement

In addition to staff with PhDs and NRF ratings, a number of staff held high-level positions:

- Prof Karel Stanz was the editor-in-chief of the *South African Journal of Human Resource Management* (SAJHRM) since 2014, and from 2016, served on the editorial board of the *Human Resource Management Review*. In 2011, he was elected as president-elect for the Society for Industrial and Organisational Psychology in South Africa (SIOPSA) and in 2012 became president of this society.
- A number of academic staff served as section editors for the SAJHRM, namely Profs Stella Nkomo and Chantal (C) Olckers, and Drs Herbert (H) Kanengoni and Sumari (SM) O'Neil.

- Profs Stanz and Nkomo were part of the founding executive of the African Academy of Management (AFAM), and Prof Nkomo became the inaugural president in 2013.
- Prof Hoobler was on the editorial team of the *Academy of Management Journal* (AIM) since 2016. In the same year, she joined the *Journal of Applied Psychology* as an editorial board member. Prof Hoobler was a member of the Catalyst Braintrust on Root Causes of Gender Inequality in the Workplace since 2014. She was also an executive committee member of the Academy of Management Diversity and Inclusion Theme Committee since 2013.
- Prof Nel was an associate editor of the *South African Journal of Economics and Management Sciences*. He was also a section editor of the *South African Journal of Industrial Psychology* with colleagues in the Department, namely Profs Nkomo, Nasima (N) Carrim, Koekemoer, Chantal (C) Olckers and Schaap.
- Between 2015 and 2018, the Department received the EMS Faculty Award for the Best Senior Researcher in Management Sciences (Profs Nkomo, Olckers, Meiring and Nel were recipients); and in 2016, Prof Carrim was the recipient of the Junior Researcher Award.

Apart from UP awards, staff also received national and international recognition for their research:

- In 2011, Prof Nkomo was the joint recipient of the Distinguished Woman Scholar in Social Sciences or Humanities Award of the Department of Science and Technology (DST). In 2014, she received the NRF Champion of Research Capacity Development Award; and in 2017, the International Leadership Association Lifetime Achievement Award.
- In 2017, Prof Hoobler was among a number of leading scientists who were inducted as new members of the Academy of Science of South Africa (ASSAf).
- In 2018, Prof Hoobler and Prof Stella Nkomo's article, 'The business case for women leaders: Meta-analysis, research critique, and path forward' was listed as one of the ten most read articles in the *Journal of Management*.
- Prof Carrim received the 2013 Emerald African Management Research Fund Award for her research project, 'Pathway to management: South African Indian male managers' identity struggle'.
- Prof Meiring was recognised for his contributions to assessment centres in South Africa at the 38th Annual South African Assessment Centre Study Group (ACSG) conference held in Sandton in 2018.

## Programmes, accreditation and links with industry

With respect to the undergraduate and postgraduate programmes, the Department offered the following qualifications: BCom (HRM), BCom Honours (HRM), and two coursework master's degrees, MCom (HRM) and MCom (IPS).

External quality assurance of programmes took the form of an international peer evaluation in 2009 where programmes were assessed to be on par with international curricula. This was followed, respectively in 2016 and 2017, by the re-accredited of programmes by the Health Professions Council of South Africa (HPCSA) and the South African Board for Peoples Practices (SABPP). The value of this re-accreditation was that professional boards monitor the content of the programmes in five-year cycles for relevance and quality. With the HPCSA, the MCom (IPS) and the internships programme were re-accredited; and with the SABPP, the undergraduate to postgraduate human resource management and labour relations programmes.

Apart from these important accreditations, the Department also had its own initiatives to keep industry involved with students and the ongoing transformation of the curriculum. One such initiative was the annual Career Fair which, since 2017, had been organised by HR Tuks, the Department's Student Council. To strengthen the role of industry, Prof Nel established an advisory board in 2018, which include industry members and alumni. The role of the Advisory Board was to assist the Department in connecting students with industry, and to ensure that the Department's programmes remained aligned with the needs of industry.

During 2017 and 2018 the Department embarked on a process of reviewing the curriculum of undergraduate and postgraduate programmes. The focus in the undergraduate programme was on ensuring better alignment with the demands of a changing workplace. The honours programme was split into two distinct degrees, namely the BComHon (IPS) and the BComHon (HRM) and (LR). Both programmes introduced new content to ensure greater specialisation and that students were ready for mid-level management roles. Both programmes also included community engagement projects as part of students' social responsibility development.

A further innovation was the doctoral learning programme which was introduced in 2015 by Prof Hoobler. The programme was designed to expose doctoral students in their first year of study to several aspects related to their base discipline, followed by advanced methodologies (quantitative

and qualitative) that could be used in students' doctoral studies and research output.

## 7. Marketing Management

### Leadership and restructuring

Prof Gustav (G) Puth was the Head of Department of Marketing and Communication Management at the start of the review period. He was the first Head of Department when it was first established in 1994, and in October 2008 returned to this position after 10 years in the private sector.

During the period 2013 to 2014, and due to structural changes in the EMS Faculty, the Department of Marketing and Communication Management was split into the Department of Marketing Management and the Communication Management Division, the latter to become part of the Department of Business Management. Prof Yolanda (Y) Jordaan was appointed as the Head of the newly formed Department of Marketing Management, and served in this position until beyond the period under review. Prof Ronel (RS) Rensburg was appointed as the Head of the Communication Management Division, and Prof Berendien (BA) Lubbe as the Programme Coordinator of the Tourism Management Division. As of 1 January 2018, the Tourism Management Division was incorporated into the Department of Marketing Management.

### Highlights of achievement

Several members of staff were recognised for outstanding teaching and learning and research performance during the period under review. In 2011, Mignon (M) Reyneke was selected as the Outstanding Reviewer at the Emerald Literati Network Awards. In the same year, Prof Lubbe in the then Department of Tourism Management received the UP Teaching and Learning Laureate Award. In 2013, Drs Melanie (M) Wiese and Gene (G) van Heerden received the Laureate Award for the Honours Programme based on 'the apprentice style' learning approach. Prof Ernie (E) Heath received the 2010/2011 Best Teacher Award at the University of Applied Sciences, Bremen (Germany), where he was a visiting professor. Dr Tania (T) Maree in the Department of Marketing Management was awarded the EMS Faculty Best Junior Researcher Award (2016), and Dr Wiese the Best Senior Researcher Award (2017) for Management Sciences.

Students of the Department performed well at national and international levels. In 2016, Mahlodi (M) Kgatle, a Marketing Management student, participated in the Young African Leaders Initiative (YALI) launched by President Barack Obama in 2010. In 2018, the recipient of the Allan Gray top student award was an honours student, Ahmed (A) Elbeiti. In the same year, Kerry (K) van Zyl was selected as one of the GradStar Top 100 students from a pool of 4000 students.

The Department and individual staff members also continued to make significant contributions outside the immediate university environment; to illustrate:

- In 2010, the Department of Tourism Management was actively involved in the FIFA Soccer World Cup.
- In 2011, Prof Rensburg was elected as president of the Public Relations Institute of Southern Africa (PRISA), while Prof Jordaan co-founded the South African Customer Satisfaction Index (SAcsi). In the same year, Dr Van Heerden was nominated to serve on the Digital Media and Marketing Association, a South African-based entity.
- During 2013 to 2015, the Division Tourism Management developed and presented Visitor Information Centre Management training courses on behalf of the Department of Transport.

At the end of 2018 the Department of Marketing Management had three NRF-rated researchers, namely Prof Yolanda Jordaan (C3), Prof Pierre Mostert (C3), and Prof Mike Ewing (B1). Also, it had produced quality research outputs in fields such as media, branding, relationship marketing, services marketing and consumer decision-making.

### Partnerships with industry

During the period 2016 to 2018, the Department of Marketing Management, in conjunction with Enterprises University of Pretoria (E@UP) and Toyota South Africa, launched the Ses'fikile programmes geared towards upskilling the taxi industry. The programme was valued at over R20 million.

Both the Department of Marketing Management and the Division of Tourism Management continued to build strong relationships with industry. In 2012, a three-year sponsorship agreement was signed with GfK (Nuremberg Society for Consumer Research, *Gesellschaft für Konsum, markt- und absatzforschung E.V.*) to establish a marketing research programme. During the same period the Division of Tourism Management signed a memorandum of understanding with the Department of Tourism for collaboration in tourism research and skills development.

The continued involvement of industry partners with the Department's student projects gave graduates a competitive edge when entering the job market, compared to students without this exposure. Industry partners in the review period included Bridgestone SA, Coca-Cola (Appletiser), Bosch SA, Discovery, Hatfield City Improvement District, Momentum, Gautrain Management Agency, Potatoes SA, Unlimited Titans. So too did the Tourism Management Division ensure the involvement of several agencies and industry partners in student projects; for example, MSC Cruises, uShaka Marine World, South African Tourism, United Nations World Tourism Organisation, Mauritius Tourism Board, Tshwane Tourism Authority and Western Cape Tourism.

At the level of the curriculum, and in alignment with the needs of the industry, the Department of Marketing and Communication Management introduced, in 2009, an MCom and MPhil in Marketing Management, and an MPhil in Communication Management. In 2014 the Department launched the MPhil Marketing Research programme in collaboration with GfK Verein (Germany), a think tank organisation dedicated to global market research. The Tourism Management curriculum was adapted while new modules, such as eTourism, were added and a one-year MCom coursework programme in Marketing Management was implemented in 2015.

## 8. Public Management and Administration

Prof Jerry (JO) Kuye was the Director of the School for Public Management and Administration (SPMA) for the period 2000 to August 2014. Prof Margaret (M) Chitiga-Mabugu was appointed as the new Director on 1 September 2014 and served in this leadership position until beyond 2018.

In addition to the leadership changes, there were important structural changes and innovation, in particular related to curriculum transformation. In 2017, the SPMA established an advisory board, consisting of academics and practitioners from South Africa and abroad. Board members act as ambassadors and were responsible for guiding the SPMA.

In 2018, in celebration of its 25th anniversary, the SPMA collaborated with Prof Machiel (MS) de Vries on a book project. The publication, *Public Administration: reflection, relevance and readiness*,<sup>3</sup> showcased the research interests of SPMA staff.

<sup>3</sup> MS de Vries, G van Dijk and M Chitiga-Mabugu. 2018. *Public Administration: Reflection, Relevance and Readiness*. Pretoria, South Africa: NISPAcee.

### Programme changes

There were a number of programme changes at undergraduate and postgraduate levels. The BAdmin (Public Management) and BAdmin (Public Administration) programmes, aimed mainly at students who were in full-time employment, was phased out in 2018 to focus on a new offering, the Postgraduate Diploma in Public Administration. The phasing out of the BAdmin degree was also to consolidate programme offerings at the undergraduate level.

Since 2017 a more rigorous quantitative methodology module was included in the second year of the undergraduate curriculum. This assisted in setting the SPMA graduates apart in the field of Public Administration and Management from graduates with a similar qualification. It also allowed more flexibility at postgraduate levels with respect to possible research approaches that could be pursued.

In recognition of the somewhat fragmented nature of the core full-time undergraduate degree, the SPMA embarked on a process to consolidate the BAdmin (International Relations) and BAdmin (Public Management) degrees into one offering. This was done by combining the programmes in such a way that students could choose either to focus on International Relations or on Public Administration and Management. The name of the degree was changed to the BAdmin (Public Management and International Relations) to reflect changes in the content of the curriculum.

In 2015, the UP Senate approved the revised honours degree which was restructured to phase out electives and introduce five core modules, and to combine the two honours degrees into one degree, namely the BAdminHon (Public Management and Administration). A new requirement introduced was that students needed to write an extended project as one aspect of their final assessment.

At the master's level, substantive restructuring and consolidation took place in 2017. The three MAdmin degrees were consolidated into one degree, namely MAdmin (Public Management and Policy).

Further, the Master of Public Administration (MPA) also underwent restructuring and consolidation. The degree changed from a four-year degree to a two-year degree, and the offerings were recrafted to suit best practice in the field, in line with requirements for managers in the public sector.

Major restructuring also occurred at the PhD level. During the review period, the first step was to consolidate all the PhD offerings into one PhD degree in Public Administration and Management.

### Highlights of achievement

During the review period, members of the academic staff were recognised in several ways:

- Dr Mapula (M) Nkwana was awarded the EMS Faculty Teaching Excellence Award in 2016 and Dr Michel (MM) Tshiyoyo received the Junior Researcher of the Year Award in the same year.
- Prof Chitiga-Mabugu received her C1 NRF rating in 2017.
- In 2017 Prof David (DJ) Fourie received the EMS Faculty Senior Researcher of the Year Award, and Prof Natasja (N) Holtzhausen the Teaching and Learning Award for the community engagement module she taught.
- In 2018 Prof Chitiga-Mabugu was one of eight staff members from UP who were inaugurated as part of the cohort of 20 new Academy of Science of South Africa (ASSAf) members. In the same year, she was also appointed to serve as a member of the Science Advisory Council of the Stockholm Environment Institute (SEI).

A further area of achievement and visibility for the SPMA in the period under review was its hosting of conferences which attracted national and international academics and practitioners. For example, the 7th Annual SPMA International Conference on Public Administration, hosted in 2014, drew participants from several countries. The well-respected public intellectual, Prof Thuli Madonsela, gave the keynote address.

### Collaboration

The SPMA continued to have strong collaborations with Kehl University of Applied Sciences (Germany) and signed a renewed memorandum of agreement in 2009. This agreement included annual visits by the University of Kehl, as well as student and staff exchanges.

In 2015, the SPMA was commissioned by the Japanese International Corporation Agency (JICA) to conduct research on the public finance system and urban development

mechanism in Japan. Also in 2015, the SPMA was approached by the University of South Africa (UNISA) to facilitate the public management track for the Young African Leadership Initiative (YALI) funded by USAID. The programme was judged as a resounding success by the funders and the participants.

The SPMA also remained active with respect to short-term consultancies and presenting short courses through E@UP. For instance, a proposal submitted in response to an open competitive tender from the National School of Government for an 'Emerging and Advanced Development Programme' was awarded to the SPMA in August 2017 for a three-year period. This programme was aimed at offering short courses to junior and senior managers in the South African government.

In 2018, the SPMA participated in a collaborative project with National Treasury on three sub-themes: integrated human settlements (housing), inclusive economic development, and sustainable finances.

## 9. Taxation

### Leadership

Prof Madeleine (M) Stiglingh was the Head of the Department of Taxation for two terms, from 2003 to 2015. Prof Theuns (TL) Steyn was appointed for a brief two-month period in an acting capacity, from January to February 2016, before his appointment as the new Head of Department in March 2016. Prof Stiglingh presented her inaugural lecture on 6 November 2014, titled 'Transparency on the "Circle of Taxation"', and Prof Steyn his on 11 September 2018, titled 'Sleeping beauty and the tax burden'.

The Department's staff compliment remained stable during the review period with 16 academic staff and three administrative assistants. During this period, three extraordinary professors were appointed to assist with PhD supervision and to mentor academic staff with their research endeavours: Prof Ruanda (R) Oberholzer (January 2010 to December 2012) and Prof Kevin (K) Holland (January 2013 to December 2015), both from the University of Southampton (UK); Prof Chris (C) Evans from the University of New South Wales (Australia) was appointed from January 2013 and served in this capacity beyond the review period.

### Events and achievement

In 2011, the Department of Taxation celebrated its ten-year anniversary. In celebration of this milestone, the Department hosted a function on 12 May 2011 where the well-known South African economist, Mr Mike Schüssler, was the guest speaker. His presentation was titled 'Tax to the future'.

Six academic staff in the Department completed their doctoral qualifications: Prof Steyn (2012), Dr Sharon (SA) Smulders and Dr Gerhard (G) Nienaber (both in 2013), Prof Elmar (ER) Venter (2014), Prof Hanneke (H) du Preez (2016), and Dr Teresa (T) Pidduck (2018). By the end of 2018, all academic staff held, at minimum, a master's qualification.

Between 2009 and 2018, staff in the Department contributed 44 research output units in accredited journals and successfully supervised 346 master's and four doctoral students.

Further research achievements included:

- An NRF grant awarded to Dr Sharon Smulders in 2012 for her research titled, 'Impact of the South African tax system on the tax compliance costs and benefits for small businesses'. This study was part of an international research project (spanning six countries) that evaluated and compared tax compliance costs affecting the small business sector.
- Prof Steyn won the award for the best PhD thesis in the doctoral category of the Norton Rose South Africa Tax Thesis competition in 2012. Dr Smulders continued the Department's winning tradition in 2013, also as the winner in the doctoral category of this competition.
- In 2015, Prof Steyn was awarded the Australasian CCH/ ATTA Doctoral Series Award for his thesis titled, 'A conceptual framework for evaluating the tax burden of individual taxpayers in South Africa'.

The Department hosted the launch of the South African Tax Educators' Association (SATEA) at the University of Pretoria in June 2012.

In 2016, the Department, in partnership with the University of New South Wales and the South African Institute of Chartered Accountants (SAICA), presented a tax symposium titled, 'Value-added Tax (VAT): An Africa perspective'. The aim of the symposium was to build international networks for African tax scholars. The symposium subsequently became an annual event. In 2017, the symposium was titled, 'Tax and corruption: An Africa perspective'; and in 2018, 'Tax simplification: An Africa perspective'.

Students in the Department of Taxation were exceptionally successful in the annual EY Young Tax Professional of the Year Competition:

- In 2013, Mr Johan (J) Small won the competition nationally and was placed third internationally. In 2014, Mr Benjamin (B) Mbana was placed first in the competition both nationally and internationally. This achievement was repeated in 2016 by Mr Karl (K) Frenzel who also won the competition nationally and internationally.

### Programme changes

During the review period programme and qualification changes included:

- The introduction, in 2011, of a PhD in Taxation.
- The introduction, in 2013, of an innovative new-generation master's degree in taxation. The objective was to produce skilled and inquisitive scholars who could become thought leaders in the next generation of tax professionals. This new programme adopted an innovative approach to knowledge transfer by exposing students to active learning in real-world contexts.
- The introduction in 2009 of a BCom (Taxation) degree was the first at a university in South Africa. The degree was offered until 2012. In 2013, it was replaced with a generic BCom (Financial Sciences) degree.





## 2 | Education

### DEAN'S OVERVIEW

The Faculty of Education is one of the largest and most diverse faculties at universities in South Africa responsible for the initial and advanced training of education professionals. Located at the University's Groenkloof Campus, the Faculty is home to five departments.

#### *Leadership and change*

During the period 2009 to 2018, there was a transition in leadership: Prof Irma (I) Eloff served as Dean for two terms, from 2008 to 2016, and was succeeded in 2016 by Prof Chika (CT) Sehoole, who was previously the Head of Department of Education Management and Policy Studies.

In 2009, the Faculty's two schools and seven academic departments were restructured into five departments: The departments, and the first heads of department at the time of restructuring, were: Early Childhood Education — Prof Cyclic (CG) Hartell; Education Management and Policy Studies — Prof Johan (JL) Beckman; Humanities Education — Prof Adelia (A) Carstens; Educational Psychology — Prof Ronel (R) Ferreira; and Science, Mathematics and Technology Education — Prof Max (MWH) Braun.

In February 2009, a new managerial position was created and Prof Ana (A) Naidoo was appointed as the Deputy Dean: Teaching and Learning. She was succeeded by Prof Braun in 2013, following her appointment as Deputy Director in the Department of Education Innovation. Prof Braun held the position of Deputy Director: Teaching and Learning until his retirement in 2017 and was succeeded by Prof Salome (S) Human-Vogel who was appointed in August 2017.

During the review period, the Faculty of Education benefited from a new phase of infrastructure development which saw the addition of a number of state-of-the-art lecture halls and laboratories, the introduction of high-technology facilities, and disability access to buildings. In this period, a multi-faculty teacher education model was implemented to prioritise subject-specific knowledge and pedagogical skills. The model opened pathways for prospective teachers to pursue postgraduate studies in disciplinary fields other than Education.

#### *Programme and qualification change*

There were several programme and qualification changes between 2009 and 2018.

The first changes were to the BEd programme in 2011, which were the result of areas of weakness identified; for example, the uneven credit spread which overloaded some students, and inadequate methodology modules and teaching practice training. In addressing these problems, electives were moved to the partner departments on the Hatfield Campus, while education-specific modules were updated. This exercise produced excellent results — and a more relevant and transformed curriculum, which rid itself of traditional and outdated approaches to education.

The second set of changes, again related to the BEd programme, was in 2016 and was the result of the introduction of the new Minimum Requirements for Teacher Education Qualifications (MRTEQ) policy. The biggest change was the requirement that school placement for Work Integrated Learning (WIL) be introduced from the second year onwards and not be confined only to fourth-year students. This had major implications for teaching and learning and the workload of academics. Combined with the increase in enrolment, the increased workload implied the collapse in the distinction between what was then known as teaching departments as opposed to research departments. All departments needed to become involved in WIL and, at the same time, increase research output and postgraduate supervision — in line with the University's long-term strategy. The requirement that all departments be involved in visiting students at schools meant less time available for research and postgraduate students. However, the Faculty's agility in navigating these constraints is demonstrated in the increase in research and postgraduate outputs during this period.

## Performance at a glance

Prof Sehoole's leadership was characterised by a phase of transformation. In 2017, to ensure inclusive and equitable access to quality education, he initiated a country-wide recruitment drive targeting, in particular, rural African and coloured youth as prospective teachers. In collaboration with the Department of Basic Education's Funza Lushaka Educators' Merit Bursary Scheme and the National Student Financial Aid Scheme (NSFAS), deserving candidates were admitted into the BEd programme to study toward becoming Mathematics and Physical Science teachers. They hailed from rural districts and townships in six provinces, namely the Eastern and Western Cape, Gauteng, Limpopo, North West and Mpumalanga.

The Education Faculty experienced a steady increase in undergraduate students, moving from 2 801 headcount enrolments in 2009 to 3 826 by 2018. The percentage of black undergraduate enrolments increased from 46,0% to 60,0% in the same period. The student to staff ratio stood at 27,8 in 2018. The focus on international students is shown in the enrolment figures with 137 students from outside South African borders enrolled in undergraduate programmes, and 116 for postgraduate studies.

By the end of the review period, 92 academics were appointed and 69,6% had doctoral degrees. The number of black academics increased from 35,2% in 2009 to 40,2% in 2018. The number of NRF-rated researchers rose from 10 in 2009, to 22 by 2018.

At an international level, the Faculty had been ranked, since 2013, in the top 200-300 band globally in the Education subject field of the Quacquarelli Symonds (QS) World Subject Rankings.

## Accolades and achievements

The Faculty is regarded as a leader in teacher education and research in South Africa and Africa as evidenced by, among others, individual and faculty achievements (see also the respective department texts). Some of the awards included:

- Prof Saloshna (S) Vandeyar was the recipient of a mid-career award given by the American Education Research Association (AERA) (2011).
- Prof Eloff was awarded the International AIDS Society (IAS) and the Coalition for Children Affected by AIDS Prize of Excellence for HIV research related to children (2014).



Prof Chika Sehoole, Dean | 2016-2018 and beyond

- Die Suid-Afrikaanse Akademie vir Wetenskap en Kuns (SAAWK) awarded Prof Kobus (JG) Maree the Stals prize for his exceptional research and contribution to Psychology (2009) and Education (2014).
- Prof Liesl (L) Ebersöhn and Prof Linda (LT) Theron were awarded the GCRF Resilience Foundation Award (2016).
- Dr Celeste (C) Combrink was the winner of the Tim Dunne Award Visiting Scholar, University of Melbourne Australia (2016/17).
- Prof Ebersöhn was also the recipient of the Education Association of South Africa (EASA) Researcher Medal (2018).

<sup>1</sup> DHET. 2013. *White Paper for Post-school Education and Training. Building an expanded, effective and integrated post-school system.*



Prof Irma Eloff | Dean, 2008-2016

## Teaching and learning

The Faculty continually revised its programmes to align with changes in the national school curriculum while ensuring local relevance and promoting excellence in the design and delivery of teacher education programmes.

The Postgraduate Certificate in Education (PGCE) is an advanced certificate-level qualification that provides teaching registration for graduates of non-education bachelor degrees. This qualification was expanded during the review period to an Advanced Diploma to include the Technical and Vocational Education and Training (TVET) college sector; a sector identified by the South African government as critical in an expanded post-school education and training system. As captured in the 2013 *White Paper*, over time, this sector needs to accommodate up to two-thirds of all school-leavers.<sup>1</sup>

With respect to technology-supported education in its postgraduate programmes, the Education Faculty continued to play a leading role at UP. Between 2015 and 2017, the BEd honours programme was re-curriculated while a pilot project was initiated to develop an online master's module intended to accelerate the completion of students' research proposals at this level.

A new initiative, introduced in the second semester of 2017, was to present — in a hybrid form — the Education modules at first, second and third-year levels. The Computer Integrated Education group in the Department of Science, Mathematics and Technology Education — and staff who had gained experience in the honours and master's projects — provided extensive leadership in this undergraduate project.

## Research and postgraduate education

During the review period, a research culture was actively promoted and staff had access to sufficient resources to undertake meaningful research. Consistent growth in the volume and quality of research outputs, and the international recognition of the Faculty and its members through awards and citations, were testimony to a vibrant research community. Accredited journal publications per academic increased to 53,87 units while the total number of research outputs improved from 30,50 in 2009 to 71,06 by the end of 2018.

The Faculty also had 21 NRF-rated researchers with Prof Kobus (JG) Maree holding a B1 rating. He has been credited for his work in introducing career construction and life design counselling in severely disadvantaged Southern African contexts.

Further, the Education Faculty hosted three research centres and one unit during the review period, with each operating in collaboration with academic departments:

- The Centre for Evaluation and Assessment (CEA)
- The Centre for the Study of Resilience (CSR)
- The Centre for Visual Impairment Studies (CVIS)
- The Living Lab for Innovative Teaching Research (LLITUP) Unit.

These entities provided research leadership for academic staff, contributed to postgraduate research capacity, attracted external funding, and helped increase the Faculty's research outputs. Details are provided in each departmental section.

Research projects typically addressed societal problems and challenges, with examples including:

- The impact of HIV/AIDS on learning
- Resilience in education and research
- The levels of literacy and numeracy of pupils in the South African schooling system



- The value of all people and the strength obtained from diverse cultural and language backgrounds, physical and cognitive ranges of ability
- Technology-based or supported learning, mobile technologies and questions arising from their use.

Capacity development initiatives supported emerging academics at lecturer and senior lecturer levels, to develop and strengthen their research, supervision and academic writing skills. This involved workshops, often in partnership with the Department of Research and Innovation (DRI) and UP Libraries. The Faculty also offered an intensive support and development programme for master's and doctoral students that led to a substantial increase in the number of successful graduates.

During the period under review, 258 candidates graduated with doctoral degrees while 520 students completed their MEd degree. The highlight of the Faculty's performance was in 2018 when it produced 47 PhDs and 86 master's graduates, demonstrating its research growth and capacity to contribute

to the University's strategic goals and societal development. The number of master's and doctoral degrees awarded to black candidates improved from 47,1% in 2009 to 51,1% by 2018. The number of international students (mostly from the African continent) had steadily increased from just over 50 students to 116 by the end of the review period.

A notable research project funded by the National Research Foundation (NRF) was undertaken between 2015 to 2017, under the leadership of Prof Billy (WJ) Fraser — 'The Fourth-Year Initiative for Research in Education' (FIRE) project. It entailed a participatory methodology involving more than 2 300 final-year student teachers who were engaged in their work-integrated learning at schools. The project involved cycles of reflection, planning and action taking place within a community of practice, to strengthen the participants' professional teacher identities. The aim was for the student teachers to have agency for their own professional development by sharing experiences and ideas, planning ways to address the challenges they faced, and collaborating with others who shared a similar interest.

## Internationalisation and partnerships

The Education Faculty established several strategic partnerships that addressed initiatives of the Faculty and UP with an emphasis on relevance, social responsiveness, and international collaboration. Some relationships were formalised by signing a memorandum of understanding which, for the period under review, included:

- **Concordia University** (Canada, 2009). Dr Rinelle (R) Evans spent four months in Montréal working with Prof Ailie (A) Cleghorn on an NRF-funded postdoctoral project linked to bilingualism.
- **University of Nebraska-Lincoln** (US, 2009). Prof Vandeyar was instrumental in forging a formal partnership with this institution through the work of Prof Ted (E) Hamann. The agreement included bi-directional study visits to promote international understanding of especially transnational and immigrant learners.
- **The Northeast Normal University** (NENU, China, 2012). This agreement strengthened research collaboration and served as a training ground for research capacity building and article writing. A collaborative research project involving five staff members from the Department of Education Management and Policy Studies and their counterparts at NENU, with a focus on school leadership in both countries was initiated in 2013, following exchange visits between the two institutions. This project had multiple benefits in that it gave exposure to early career academics to international travel, and to inter-institutional collaboration with immersion in research through project planning, execution, and writing of reports and articles for publication. The major benefit of this transnational project was that five of the UP participants delivered research outputs that contributed to career mobility. One researcher, Dr Eric (E) Eberlein, completed his PhD studies; another, Dr Teresa (T) Ogina, was promoted to a senior lecturer level; and three staff members — Dr Christian (C) Amsterdam, Dr Vimbi (V) Mahlangu and Dr Sharon (S) Mampane — accepted associate professor appointments at universities both locally and abroad.
- **Fordham University** (US, 2014–2018). The institutional partnership yielded positive results, including a six-week postgraduate exchange programme in June/July each year between 2014 and 2018. On average, two MEd students in

Educational Psychology formed part of the UP-Fordham postgraduate student exchange programme per year, participating in the Fordham University Summer School programme. Exchange visits also took place between the Deans of the Faculties of Education. The key collaboration centred around an NRF-funded research project — 'Supporting children's holistic well-being through a health-promoting intervention' — led by Prof Ronél (R) Ferreira in the Department of Educational Psychology. Intervention research was undertaken with Grade 1, 2 and 3 learners in three schools in Pretoria and two schools in the Bronx, New York City.

- **The University of Alberta** (Canada, 2015). Dr Keshni (K) Bipath and Prof Ina (JC) Joubert visited Prof Larry (L) Prochner and Prof Anna (A) Kirova at the University of Alberta. Collaboration between the two faculties included mathematics education, literacy, early childhood education, indigenous knowledge, and educational leadership.
- **Naruto University** (Japan, 2017). Funded by the Japanese International Cooperation Agency (JICA), Dr Roy (T) Venketsamy spent a month working on a Lesson Study approach with counterparts from Naruto University.
- **University of Ontario Institute of Technology** (Canada, 2018). Dr Melanie (M) Moen spent three months in Oshawa as a visiting scholar working on family murder cases from a South African perspective.
- **African Network for Internationalisation of Education** (ANIE) (2012, 2018). ANIE is a non-profit organisation whose secretariat is at Moi University in Kenya. It aims to advance the international dimension of higher education in Africa. Prof Sehoole served as Chairperson of the Board (2013–2017), and also on its research committee. During his tenure as Chairperson, ANIE conducted research on the international dimensions of higher education with a particular focus on the millennium development goals, which involved young scholars as part of its capacity development programme. In 2012 the University of Pretoria hosted the 4th ANIE Annual Conference which contributed to UP's pursuit of its African agenda.

**Prof Chika (CT) Sehoole** | Dean, 2016–2018 and beyond

## EDUCATION: PERFORMANCE AT A GLANCE

### Enrolment and success

■ Total ■ Undergraduates ■ Postgraduates

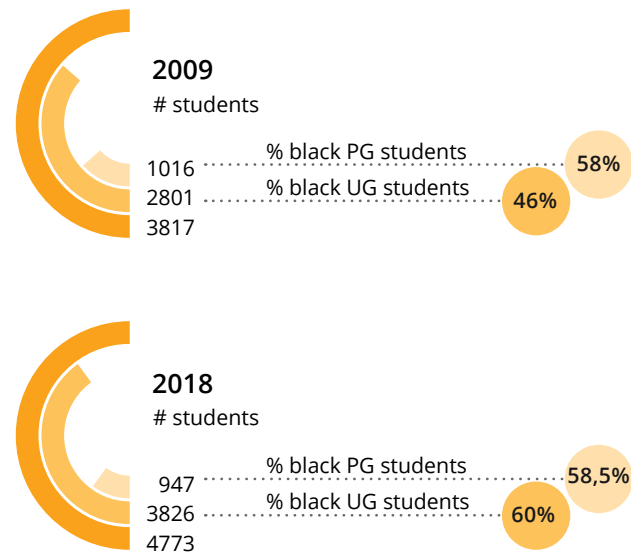

### Undergraduate module pass %

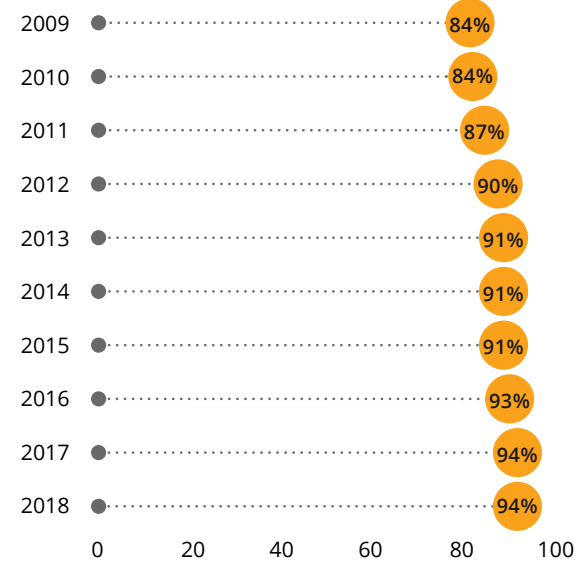

### UG graduates

■ # UG graduates ..... % black UG graduates

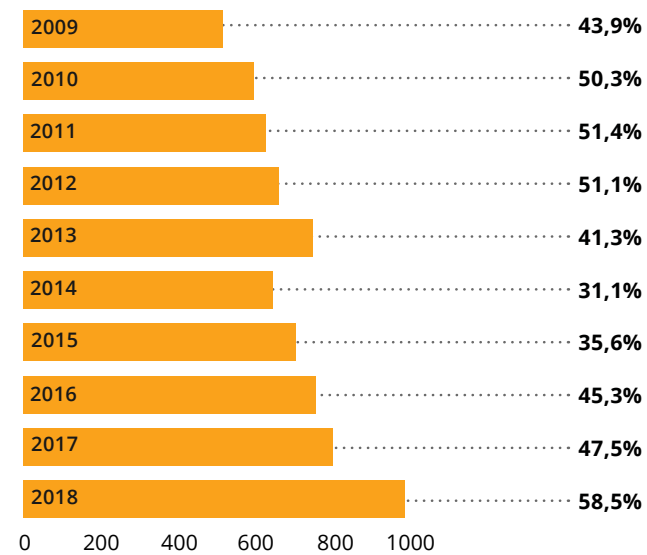

### Student : staff ratio

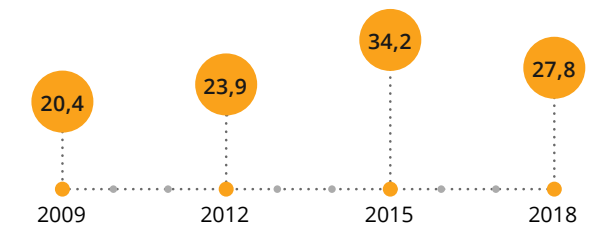

### Weighted M and D output

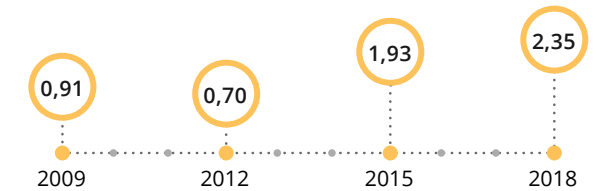

### Research pipeline

#### M and D enrolment

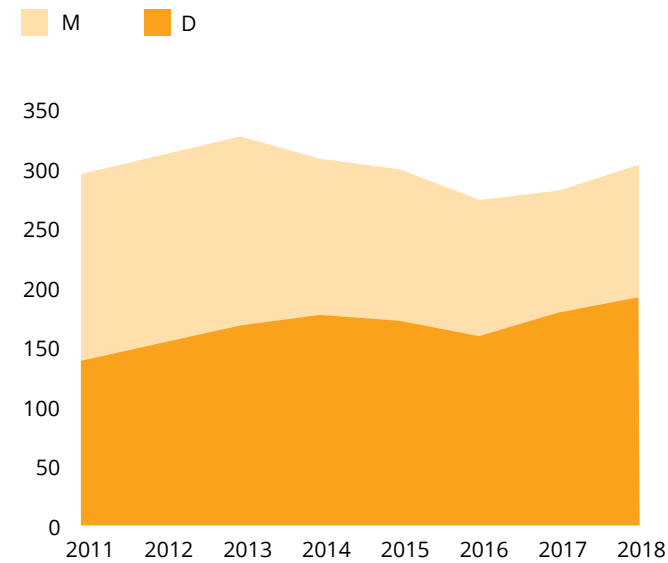

#### M and D graduates

■ M ■ D ..... % black M and D graduates

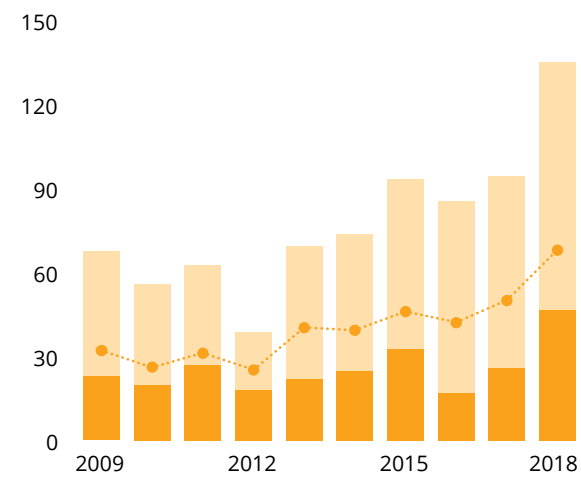

### Capacity and productivity

#### % Academic staff with PhDs

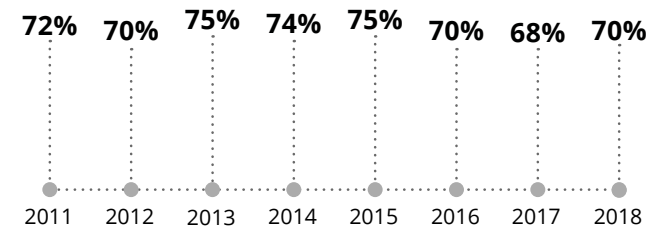

#### NRF-rated researchers, 2018



#### Research output

■ Total research units ■ Journal articles

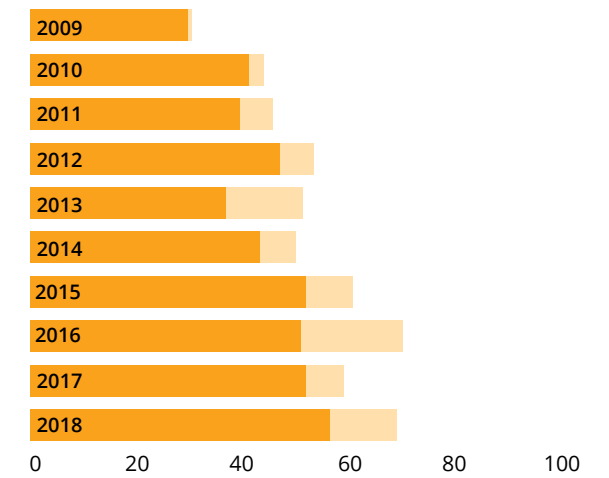

## DEPARTMENTS

### 1. Early Childhood Education

The Department of Early Childhood Education (ECE) was established in 2002 with Nkidi (NC) Phatudi as the first Head of the Department. She was succeeded by Prof Cencil (CG) Hartell who served as Head of Department for four years, from 2013 to 2016. When Prof Hartell was seconded to the Centre for Japanese Studies in the Faculty of Humanities in May 2016, Prof Ina (JC) Joubert first served in an acting capacity until her formal appointment as Head of Department in 2017. She remained in this position until her early retirement at the end of August 2018, when Prof Hartell returned to deputise beyond the review period.

The Department had two external audits since its inception with recommendations strengthening its work, and a third audit in 2014, organised by the Department for Education Innovation at UP. Key findings pertained to the confirmation of limited research capacity and output with only one PhD graduate during the review period. Furthermore, most academics in the Department did not have doctoral qualifications. This was ascribed to the Department being almost entirely teaching-focused, which was very much the legacy of its earlier teacher training college tradition that had no knowledge generation imperative. The restructuring of the Faculty in 2009 assisted in addressing the lacunae and, by 2018, the Department was successfully developing a strong research identity with an increasing number of master's and doctoral students enrolling for studies in the field of early childhood education. The diversity profile of the BEd and BEEd Honours students also was better balanced with regard to gender and race.

#### Research highlights

Two staff members received associate professorships during this period: Prof Ina Joubert and Prof Miemsie (MG) Steyn. Prof Joubert was also the first member of the ECE Department to receive an NRF C3 rating. Staff members who were promoted to senior lecturers were Dr Melanie Moen and Dr Judy (JC) van Heerden.

In collaboration with the University of KwaZulu-Natal (UKZN), the Tshwane University of Technology (TUT) and the Central University of Technology (CUT), the Department led a three-year project, from 2013 to 2015, funded by the European Union (EU) and the Department of Basic Education (DBE).

The aim of the project was the research and development of learning and teaching support materials and videos for use by universities for the effective teaching of Foundation Phase subjects. In 2016, the Department used the findings to develop a new BEd degree in Early Childhood Care and Education (ECCE). This programme provided both master's and doctoral students with financial support to research this neglected ECCE field. Through this project, 48 articles were published.

The members of the Department embraced research and supervision in several ways to strengthen skills and capacity and to increase research outputs. The Department showed an increase in published articles, scholarly books and chapter contributions, and in postgraduate supervision, with some students obtaining their qualifications with distinctions. Academic books written and edited by staff members have been prescribed by South African institutions — *Akademie Reformatoriese Opleiding en Studies* (AROS), North-West University (NWU), University of the Free State (UFS), UP and Stellenbosch University (SU) — for Foundation Phase students.

During the period under review, the Department attracted many postgraduate students from the rest of the African continent and hosted several scholarly seminars. The latter included the South African Research Association for Early Childhood Education (SARAECE), Birth-to-Four BEd Programme, LEGO Literacy and Maths, and Curriculum Transformation.

The ECE Department also collaborated with international scholars at universities such as Fordham University and New York City University (US), and with Prof Teresa (T) Harris, a Fulbright scholar from James Harrison University (US). In turn, academics from the Department participated in overseas scholarly visits through grants (see p.140 below).

Staff started to engage more strongly in scholarly pursuits through NRF rating applications, the publishing of scholarly work, and as external examiners of master's and doctoral students at other universities in South Africa, as well as serving on national boards.



### Programme and qualification changes

The Department revised the BEd Foundation Phase programme several times to ensure alignment with changes in the national school curricula. Assisted by the Faculty's Unit for Distance Education, the revision of the online BEd Honours degree in Learning Support was made possible.

The ECE Department was the only department of its kind in South Africa to receive approval at first submission from the DHET for the BEd (Early Childhood Care and Education) programme as part of the Faculty's programme and qualification mix.

## 2. Education Management and Policy Studies

### Leadership

Prof Johan (JL) Beckmann served as Head of Department of Education Management and Policy Studies at the start of the review period. He was succeeded by Prof Chika (CT) Sehoole in 2011 who remained in this leadership position until his appointment as Dean of the Faculty of Education in June 2016. Prof Sehoole was succeeded by Prof Everard (KE) Weber as the new Head of Department towards the end of 2016.

### Programme and qualification changes

The Department aimed to make a significant contribution to the transformation of the education system as a whole regarding education management and leadership, education policy studies, education financing and education law. This was achieved through formal contact programmes as well as distance education programmes and short professional programmes.

During the review period, a substantial number of undergraduate modules were allocated to the Department and new programmes were introduced. These included:

- An Advanced Diploma in Educational Leadership and Management which replaced the Advanced Certificate in Education
- A restructured BEd honours programme for distance education

- A professional MEd degree in Education Leadership to be offered online (in development)
- A professional DEd programme.

These programmes were designed to create a pathway leading to a professional DEd degree which was developed under the leadership of Dr Andre (A) du Plessis in collaboration with Prof Beckman and experts from Finland and the United States — Prof Jukka (J) Alava, and Prof Brian (BK) Perkins.

One of the distinguishing features of the Department during this review period was the offering of distance education programmes at certificate and honours levels that helped to upgrade the qualifications of many teachers in the country. Through the offering of the Advanced Certificate in Education (ACE) Leadership programme, and the honours programme in Education Management Law and Policy (EMLP), the Department had enrolled close to 20 000 students by 2010 who benefited from the expertise the Department was able to offer.

Both these programmes were gradually phased out. The Advanced Certificate in Education was replaced with the Advanced Diploma in Educational Leadership and Management and the restructured BEd Honours programme for distance education respectively.

During this period the Department also developed new professional development programmes, offered in collaboration with Enterprises UP:

- A teaching effectiveness and performance (TEPA) workshop for principals of private schools in Nigeria, sponsored by UNESCO from 2012 until 2014.
- The Education and Training Development Practices Sector Education and Training Authority (ETDP SETA) project: Mentoring and coaching school management teams in Limpopo and Mpumalanga provinces (2015).
- An executive course in process improvement methodologies, presented to delegates from the Nigerian Army (2017).

### International linkages

During the period under review, the Department developed extensive international collaboration with universities and organisations in China, Finland, Australia, the United States, the United Kingdom and other countries in Africa.



The Department was also home to the inter-university Centre for Educational Law and Policy (CELP) which was dedicated to research and training in education law. Under the leadership of Prof Rika (HJ) Joubert as Director and Dr Jean (JW) van Rooyen as the Executive Manager, the Centre produced six publications on aspects of education law and policy. These included the following ground-breaking publications:

- *An educator's guide to labour law* by Prof Joan (JM) Squelch.

- *Foundations of law and education law* by Prof Elmene (W) Bray.
- *Safe schools* edited by Prof Izak (IJ) Oosthuizen, Dr Elda (E) de Waal and Dr Annamagriet (A) de Wet.
- A CELP publication (2015), *Balancing freedom, autonomy and accountability in education*, was edited by Prof Joubert, Dr Lars (LG) Björk and Dr Tricia (T) Browne-Ferrigno from the University of Kentucky (US).

These publications were used as prescribed readings by students at Unisa, and the universities of Fort Hare and Johannesburg.

Selected papers read at two international conferences hosted by CELP in Johannesburg (2013) and in Stellenbosch (2014) were published in special editions of *Southern African Public Law* (SAPL), a DHET accredited, peer-reviewed journal in the fields of constitutional law and education law.

### Research highlights

In addition to strengthening research capacity, the Department accepted research on a contract basis for the national Department of Basic Education (DBE) and some provincial departments of education. Projects included:

- An analysis of the South African Schools Act No. 84 of 1996 (SASA) to explore possible amendments
- The development of a possible model for the training of school principals and guidelines for school governing bodies
- An assessment of the baseline data collected for the Circuit Improvement Project for circuit managers in Limpopo
- The reorganisation of Colleges for Vocational Education prepared in conjunction with KPMG.

The Department also undertook collaborative research with international agencies, with examples including the design of a legislative framework for human resource management in the education and training sector, Montreal and Johannesburg: Canada South Africa Education Management Project (CSAEMP); and a report drafted for Enterprises UP and Irish Aid.

The three research areas that were prominent in the review period were higher education, education law with particular reference to learner safety and the legal position of school principals, and aspects of school governance and school financial management.

Finally, the Department trained postdoctoral fellows who were later appointed as permanent staff as part of the strategy to build the next generation of professors. Two postdoctoral fellowships, one in Early Childhood Education offered to Dr Samuel (S) Adeyemo who received a two-year Vice Chancellor's postdoctoral fellowship from 2012 to 2013; and the second to Dr Maitumeleng (AM) Nthontho who received the same fellowship in Humanities Education. Both

were subsequently offered academic posts in the Department of Education Management and Policy Studies and were soon promoted to associate professors.

## 3. Educational Psychology

The Department of Educational Psychology is one of the research-active departments in the Faculty of Education offering five postgraduate qualifications: BEd Hon (Educational Psychology), MEd (Educational Psychology), MEd (Learning Support, Guidance and Counselling), PhD (Educational Psychology), and PhD (Learning Support, Guidance and Counselling). The Department also offers undergraduate and distance education modules.

Two programmes are accredited by the Health Professions Council of South Africa (HPCSA): the honours and master's qualifications in Educational Psychology, with the MEd (Educational Psychology) leading to registration with the HPCSA. Furthermore, the Department runs an onsite psychological clinic where MEd (Educational Psychology) students complete their work placement.

All staff in the Department have had a training background in Psychology and most are registered with the HPCSA as Educational Psychologists.

Transformation is at the core of the profession in South Africa. Central to this is providing equitable access to psychological services for all learners in schools, especially vulnerable learners who need such services, given the lack of resources and the shortage of educational psychologists in schools.

### Leadership changes

The Department had two leadership changes in the period 2009 to 2018. Prof Ronel (R) Ferreira was Head of the Department from 2008 to 2017. Prof Ruth (R) Mampame was appointed as her successor in August 2018 and became the first black Head of the Department of Educational Psychology at UP.

### Programme and qualification changes

Several changes were implemented during the review period:

- The re-curriculum of the BEd undergraduate programmes, specifically the reconceptualising of the Education modules.

- The Advanced Certificate in Education (Special Needs Education) was discontinued in 2015.
- The BEd Honours in Educational Psychology (Counsellor/ Psychometry), registered with the HPCSA, was deactivated in 2017 to introduce a new BEd Honours Educational Psychology (Academic). The professional honours deliberately kept enrolments low to accommodate the practical clinical module which required intensive

training, whereas the academic honours did not have this constraint.

### Research highlights

Two research centres were attached to Educational Psychology during this period, and provided the opportunity for academics and postgraduates to align their interests with many established and well-funded research projects.

### The Centre for the Study of Resilience

The Centre for the Study of Resilience (CSR) was established in 2014 as part of the Department of Educational Psychology but only opened its physical offices on the Groenkloof Campus in January 2017. Under the leadership of Prof Liesl Ebersöhn, the Centre became home to academic and administrative staff as well as postgraduates and visiting academics connected to resilience research. Several other entities including the World Education Research Association Secretariat, the South African Journal of Education, and the Faculty of Education Ethics Office function under its auspices.

The Centre's focus is on systematic evidence of resilience-enabling innovations responsive to the extreme challenges often encountered in the global South. Put in different terms, the focus is on generating socially useful knowledge that would impact on the well-being of people, the planet, animals, and the built environment. In seeking sustainable solutions, CSR research embraces a diversity of transdisciplinary knowledge, leverages natural and cultural resources, and contributes to strengthening the research capacity of doctoral and early career scholars in Africa.

Productivity is demonstrated through a robust track record of peer-reviewed books, chapters, articles, conference papers, and postgraduate students.

The Centre has forged partnerships with scholars globally and with development and government agencies. During the review period the CSR attracted large-scale funding — including from the Canadian Institutes of Health Research, the British Academy, and the Synergos Institute — as well as small to medium research grants that included funding from the Nelson Mandela Children's Fund and the NRF.

In addition to collaboration and publications, the visibility of CSR is demonstrated in awards received, and through staff who have served on editorial boards, including the *Review of Educational Research*, the *Brazilian Journal of Special Education*, the *Global Journal of Psychology Research*, the *South African Journal of Education*, and the *Journal of Psychology in Africa*.

Awards have included:

Prof Ebersöhn was first runner-up of the Department of Science and Technology (DST) Women in Science Award in 2012; she was also the recipient of the Education Association of South Africa (EASA) Researcher Medal in 2018.

In 2016, Prof Ebersöhn and Prof Linda Theron received the GCRF Resilience Foundation Award.

Eight researchers affiliated with the CSR were NRF-rated during the review period: Dr Ruth (R) Aluko (C3), Prof Liesl Ebersöhn (C1), Prof Ronel Ferreira (C3), Prof Marien (M) Graham (Y1), Prof Funke (F) Omidire (C2), Prof Theron (B3), Prof Surette (S) van Staden (Y2).

### Centre for Visual Impairment Studies

The focus areas of the Centre include national and international collaboration and research in the field of visual impairment studies, the development and offering of short learning programmes, and service delivery to the community and students with visual impairment.

In 2016, the Department of Educational Psychology obtained funding from the Department of Higher Education and Training (DHET), in collaboration with the European Union, to establish a Centre for Visual Impairment Studies. Under the leadership of Prof Ferreira, the Head of the Department of Educational Psychology at the time, the development of a postgraduate teaching qualification (Diploma in Visual Impairment Studies) was also initiated, specifically aimed at education for learners with visual impairments or who are blind. This was to be the first qualification of this nature in Africa and to be offered in distance and contact mode by 2022.

Between 2016 and 2018, a large-scale project to train South African Social Security Agency (SASSA) officials from all nine provinces was overseen by the Department of Educational Psychology in conjunction with Dr Pieter (P) Smal from the Development Institute for the Deaf and Blind. The training programme, offered by Enterprises UP, involved 350 SASSA officials. The purpose was to equip SASSA officials with Sign Language skills to be able to communicate with and understand people who are deaf and who seek assistance with, for example, applying for social grants.

## 4. Humanities Education

The Department of Humanities Education remained for the most part structurally unchanged during the review period, although there were several leadership changes with four consecutive heads of department: Prof Adelia (A) Carstens (July 2009–June 2012), Prof Saloshna (S) Vandeyar (July 2012–July 2014), Prof Jan (FJ) Nieuwenhuisen (Aug 2014–June 2017); and Prof Johan (J) Wassermann (July 2017—).

The Department had for a long time been labelled a ‘teaching department’ since the majority of staff transferred from the Normaal Kollege Pretoria (NKP) after its incorporation with UP in 2002. This imposed identity had some merit since more than 170 modules were taught by 27 academics who held permanent positions supported by a pool of contract staff.

Despite this heavy teaching load — and conducting Work Integrated Learning (WIL) — staff worked hard to consolidate the departmental research and postgraduate focus by strengthening the honours programme, establishing focused niche projects, and drawing master’s and doctoral students into their research projects. These strategies enabled all staff to supervise postgraduate students in their designated projects, enabling more focused research outputs and a recognisable academic identity. Introduced in the latter half of 2017, initiatives included weekly seminars and the adoption of a cohort system of supervision to strengthen capacity and supervision.

### Programme and qualification changes

Teaching remained the cornerstone of the Department and excellent work was done. It would be hard and possibly unfair to distinguish staff who excelled in this endeavour. Carrying immense workloads, and teaching large classes was the work of every single member of Humanities Education.

There were several programme and qualification changes between 2009 and 2018:

The first set of changes was to the BEd programme in 2011. The pre-2011 BEd programme was seen as well-functioning with a clear focus on the core business of teacher education. However, the 2011 programme was lacking in many ways — the credit spread was unequal and overloaded students, and the methodology and teaching practice training were viewed as inadequate.

The two main drivers for changes to the 2011 programme were, firstly, to move the electives to the partner departments on the Hatfield Campus; and secondly, to change and update the Education modules. This was an excellent exercise and produced a more relevant and transformed curriculum, which rid itself of traditional and outdated approaches to education. This was followed by a review of the BEd programme in 2016. The programme proved to be good and conformed to all the requirements of the Minimum Requirements for Teacher Education Qualifications (MRTEQ) policy. However,



some challenges still existed with too many credits in some packages as well as too many electives from which to choose.

The 2016 programme was realigned following a year of implementation, especially regarding the credit spread in the third and fourth year. The methodologies course in the third year was reduced from a year to a semester module, and the credits from 12 to 6. In the second year, two periods per week also dropped to one, and the credits were reduced from 12 to 6. Because the electives were offered by the partner departments on the Hatfield Campus, the Faculty of Education did not have a choice in the number of credits allocated, while the credits for the Education modules were fixed by the MRTEQ policy.

Further programme and qualification changes included:

- The Postgraduate Certificate in Education (PGCE) was also aligned to the MRTEQ.
- The Teacher Education and Professional Development (TEPD) honours programme was adjusted to be a qualification serving Humanities Education only. This was a giant step forward in the postgraduate work of the

Department and was underpinned by creating modules in History, Gender, Geography, African Languages, Diversity, Critical Arts Education and Human Movement Studies.

- In 2018, the Higher Certificate in Sport Sciences programme was moved from the Faculty of Health Sciences to the Department of Humanities Education. This programme enables high-performance athletes who are actively engaged in competitive sport to gain an academic qualification after successfully completing Grade 12. Students who display academic talent in this programme are offered an articulation pathway into a BEd should they comply with the requirements. This programme is led by Leepile (L) Motlhaolwa and Louis Jacobus (LJ) van Zyl. Van Zyl is a three-time African Champion in the hurdles event and competed for South Africa at the 2008, 2012 and 2016 Summer Olympics.

### Research highlights

The teaching in the Department was underscored by research in fields ranging from diversity in education, to language and history in education.



Between 2009 and 2018, Dr Pieter (PH) du Toit, Dr Rinelle Evans and Prof Saloshna Vandeyar were acknowledged as established researchers by receiving NRF C ratings. In 2011, Prof Vandeyar was also the recipient of a mid-career award given by the American Education Research Association (AERA). Dr Du Toit and Dr Evans were promoted to the level of associate professor and full professor status by January 2018.

## 5. Science, Mathematics and Technology Education

Following the Faculty restructuring process in 2009, Prof Gilbert (G) Onwu was appointed as the first Head of Department of Science, Mathematics and Technology Education (SMTE) until his retirement later that year. Prof Max (MWH) Braun was appointed next and led the department until his promotion to Deputy Dean in 2013. Prof William (WJ) Fraser took over in an acting capacity until he retired in February 2014 whereafter Prof Rian (JJR) de Villiers was deputised for four months, followed by Dr Sonja (LS) van Putten, who served as acting head from mid-2014 to 2016. Prof Gerrit (G) Stols was appointed as Head of Department from 2016 to 2018 until his appointment as Director of the Department for Education Innovation at UP. Prof Estelle (E) Gaigher served as acting head for the remainder of 2018.

### Programme and qualification changes

SMTE is involved in the teaching of BEd students in the Intermediate, Senior and Further Education and Training phases, as well as in BEd Honours, MEd and PhD in the departmental speciality fields including Computer Integrated Education (CIE), and Assessment and Quality Assurance (AQA).

Between 2009 to 2018, the BEd and BEd Honours programmes went through several adjustments, including a substantive change in 2016 to ensure that the qualifications

adhered to the requirements of the DHET's MRTEQ policy. This policy had an impact on the Department in several ways. The majority of content modules in the BEd programme were moved to partner departments in other faculties, while specific specialisation modules, as well as all the education-focused modules, remained within the Department. There was substantial pressure on the workload of academics in the Department as most specialisation and education modules needed re-curriculum and re-development.

In addition, the Department's teaching and research foci in key areas were refined during this period, viz. science education (Physics, Chemistry), life sciences education, mathematics education, technology education (engineering graphics and design, and design and technology), computer integrated education, and assessment and quality assurance.

Each of these knowledge areas were linked to BEd Honours, MEd and PhD specialisation qualifications.

The Department was also responsible for faculty-wide modules, which included Education 212, a third of the Education 312 module, the fourth-year Research Methodology module and several of the new honours modules, both in contact and distance modes (e.g., curriculum design, educational research methodology, assessment in practice).

### Research highlights

The research output from the Department improved over the review years, as academics obtained their PhDs and initiated focused research projects.

Two research entities are situated within the Department, the Centre for Evaluation and Assessment (CEA), established in 2002; and the Living Lab for Innovative Teaching at the University of Pretoria (LLITUP) research unit, established in 2014.

### The Living Lab for Innovative Teaching Research Unit

The Living Lab for Innovative Teaching Research (LLITUP) Unit was established in 2014, under the leadership of Prof Ronel (P) Callaghan and serves as a collaborative and interdisciplinary technology research and teacher-development workspace. Here academics explore the potential offered by different technologies (both hardware and software) for teaching and learning, aligned with hybrid learning principles. The LLITUP Collaboratorium (the physical research space) was established in 2016 and was managed by Jody (J) Joubert.

The Living Lab research paradigm focuses on research seeking solutions to challenges in the educational community, in partnership with other stakeholders, which have included provincial departments of education (Western Cape, Limpopo, Mpumalanga); the Centre for Scientific and Industrial Research (CSIR); local universities (Nelson Mandela (NMU), North-West (NWU), Stellenbosch (SU) and Johannesburg (UJ)).

Research projects are aligned with computer integrated education as a knowledge field; or are derived from projects, communities of practice, or the interest of colleagues. Two doctoral and nine master's students completed their studies based on such projects, and three journal articles were published in the period under review.

### Centre for Evaluation and Assessment

Established in 2002, under the leadership of Prof Sarah (SJ) Howie, the Centre for Evaluation and Assessment (CEA) has undertaken over 70 research projects and brought in more than R150 million in contracts, commissions and grants. When Prof Howie relocated to the Western Cape in June 2017, Celeste-Marié (C-M) Combrink took over the responsibilities until January 2018 when the position was filled by Dr Surette (S) van Staden. In 2011, the Centre had its largest staff complement of 17 colleagues.

The work of the CEA has consistently added visibility and prestige to the University and the Faculty. The CEA has focused on evaluation and assessment with the purpose of monitoring and enhancing the quality of education and training in South Africa and beyond. The Centre is the national coordinating centre for international studies undertaken by the International Association for the Evaluation of Educational Achievement (IEA), which have included the Second International Technology in Education Study (SITES 2006), and the Progress in International Reading Literacy Study (PIRLS 2006, PIRLS 2011 and PIRLS 2016).

The PIRLS studies, one of the Centre's main projects since 2005, assess the levels of literacy in Grades 4 and 5 levels globally and in South Africa.

The International Performance Indicators in Primary School (iPIPS) project was hosted by CEA where more than 3 000 learners were assessed in the Western Cape alongside other learners in Australia, Brazil, England, Russia, and Scotland. This was done in collaboration with the University of Durham, UK and funded by the Nuffield Foundation.

The CEA has received grants from the Nuffield Foundation, the National Research Foundation, the Zenex Foundation, the Royal Netherlands Embassy — South Africa-Netherlands Research Programme on Alternatives in Development (SANPAD), and the Department of Basic Education. It has also undertaken contracts and commissioned work for UNESCO, The World Bank, the Australian Council for Education Research, the Michael and Susan Dell Foundation, the Japanese International Cooperation Agency, provincial Departments of Education (Gauteng, North West, Mpumalanga, Limpopo) and has repeated large-scale projects for the Western Cape Department of Education and the national Department of Education.

The Human Sciences Research Council (HSRC) has assisted with the development of teacher assessment items that can be used for formative classroom practice. Smaller projects included test development for Curro Holdings and the School Monitoring Survey in collaboration with the Tshwane University of Technology (2018).

Significant achievements included a number of PhD graduates who had worked on CEA projects, supervised or co-supervised by Prof Howie. Dr Combrink was the winner of the Tim Dunne Award Visiting Scholar, University of Melbourne Australia (2016/2017) as well as the recipient of the WERA/IEA International Scholar Visit, University of Hamburg (2019).



## 3 | Engineering, Built Environment and Information Technology

### DEAN'S OVERVIEW

#### Leadership and structure

Prof Roelf (RF) Sandenbergh was Dean of the Faculty of Engineering, Built Environment and Information Technology (EBIT) from 2009 to 2014. He was succeeded by Prof Sunil (BTJ) Maharaj who served in this leadership position from 2014 to beyond 2018.

The EBIT Faculty is organised into four Schools: Engineering, Built Environment, Information Technology and the Graduate School of Technology Management (GSTM). During the period 2009 to 2018, the Chairs of the four Schools were: Prof Josua (JP) Meyer — School of Engineering (2009–2018); Prof Tinus (MJ) Maritz — School for the Built Environment (2008–2018), followed by Prof Chrisna (C) du Plessis (2018 and beyond); Prof Theo (TJD) Bothma — School of Information Technology (2008–2016) and Prof Archie (AJ) Dick (2017–2019); and Prof Tinus (MW) Pretorius (2007–2016), followed by Prof Elma (EL) van der Lingen (2016 and beyond) — Graduate School of Technology Management.

In August 2016, the Faculty appointed, for the first time, two Deputy Deans — Prof Jan (JHP) Eloff: Research and Postgraduate Studies, and Prof Alta (AJ) van der Merwe: Teaching and Learning.

EBIT offers both undergraduate and postgraduate degree programmes, which are locally relevant and internationally competitive. The Faculty has exceptional researchers, follows a hybrid teaching model and has superb laboratory facilities. It is supported by highly motivated administrative and support staff, who included the following in this period:

- Liz (E) Jones, Head of EBIT Student Administration (2009–2018), Dorothy (D) Tau (2018 and beyond).
- Suzaan (S) Pretorius (2009–2014), Management Administration Coordinator and Faculty secretariat; Denise (D) Smit (2014–2016); and Managa (M) Devar (2017 and beyond).

Prof Roelf Sandenbergh | Dean, 2009–2014



Prof Sunil Maharaj | Dean, 2014–2018 and beyond

- Johan (J) Coetzee, Head of Human Resources (2009 and beyond).
- Mariëtte (M) Engelbrecht, Faculty Accountant (2009–2017); Matsimele (M) Mphahlele (2017 and beyond).
- Linda (L) du Preez (2009–2015), Marketing; Estie (E) Powell (2016 and beyond).
- Georgia (G) Yiallitsis, Faculty Function Coordinator (2009–2014).
- The messenger and copying facility services were provided by Jacob (J) Bahula (2009–2014), Michael (M) Matjila (2009 and beyond), Rebecca (R) Shipalana (2009–2014), Sam (S) Sebothoma (2014 and beyond), and Thozama (T) Qoko (2014 and beyond).

EBIT is highly ranked globally and programmes are accredited by statutory and professional bodies at national and international levels.

All departments prepare students for professional careers, and students in all fields are also encouraged to pursue specialised postgraduate studies. There are 30 research chairs and entities, which attract both high-quality staff and students. Close ties with industry partners enhance the relevancy of academic programmes. The continual search for opportunities to collaborate nationally, regionally and internationally extends EBIT's research network and enables students to acquire scarce and specialised skills. As a result, there is a high demand for EBIT graduates.

### 60 years of engineering

In 2016, under the leadership of the Dean, Prof Maharaj, there were significant milestones, including the 60th anniversary celebration of the School of Engineering. From humble beginnings in 1956 when 64 students enrolled in what was the then Faculty of Engineering, there had been remarkable growth and development. The celebratory event on 12 March 2016, hosted by the Vice-Chancellor, Prof Cheryl de la Rey, and Prof Maharaj, showcased pioneers and current stakeholders in acknowledgement of a legacy of hope, innovation and change. The keynote speaker was Norman (N) Mbazima, the CEO of Kumba Iron Ore. He shared the stage with Prof Gerrit (GT) van Rooyen, who served as the first Head of the Department of Metallurgical Engineering in 1959, and Prof Jan (J) Malherbe, who was the Dean of the Faculty of Engineering from 1989 to 1998.



In the same year, the Faculty hosted its first EBIT Week, which took place from 29 March to 1 April 2016. It served as an excellent marketing tool for the Faculty to attract top school-leavers in Mathematics and Physical Science from across South Africa and neighbouring countries. Linked, and as part of the Faculty's 60 Years of Engineering, companies such as SENTECH, POWERTECH and Air Traffic and Navigation Services (ATNS), sponsored female students from disadvantaged backgrounds who were in their final year of schooling to attend the Engineering Week. To qualify for selection, prospective students needed to have achieved an average of 70% in Mathematics and Physical Science.

The EBIT Week was repeated in the following years with great success.

In August 2017, the Faculty presented its first bursary event for women, to honour the top 100 Grade 12 women who applied to study engineering at UP and were admitted to one of the EBIT programmes for 2018.

### Highlights of achievement

There were several outstanding individual achievements by staff and students during this period, which are described in the department texts that follow. Some of the most prestigious were:

- Prof Thoko (T) Majozi, Department of Chemical Engineering, was the recipient of the National Research Foundation (NRF) President's Award in 2009 for his role in transformation of the science cohort in South Africa. In 2010 he received the South African Institution of Chemical Engineers (SAChE) Bill Neal-May Gold Medal Award for outstanding achievement and international recognition. Also in 2010, Prof Majozi was elected as Vice-President of the Engineering Council of South Africa (ECSA), while Prof Madeleine (M) du Toit, Department of Materials Science and Metallurgical Engineering, was appointed as President of the Southern African Institute of Welding (SAIW).

Table 4.1. Comparison of student numbers in EBIT between 2009 and 2018\*

Faculty of Engineering, Built Environment and Information Technology							
	Race	2009			2018		
		Male	Female	Total	Male	Female	Total
Undergraduate	African	417	296	713 (16%)	2168	1061	3229 (41%)
	Coloured	18	6	24 (1%)	124	43	167 (2%)
	Indian	143	85	228 (5%)	469	157	626 (8%)
	White	2502	991	3493 (78%)	2983	856	3839 (49%)
	Undisclosed	—	—	—	19	4	23 (0.2%)
<b>Total</b>		<b>3080 (69%)</b>	<b>1378 (31%)</b>	<b>4458 (100%)</b>	<b>5763 (73%)</b>	<b>2121 (27%)</b>	<b>7884 (100%)</b>
Postgraduate	African	362	101	463 (25%)	1078	723	1801 (55%)
	Coloured	25	4	29 (2%)	45	26	71 (2%)
	Indian	59	15	74 (4%)	137	57	194 (6%)
	White	1023	267	1290 (69%)	912	315	1227 (37%)
	Undisclosed	—	—	—	4	5	9 (0.2%)
<b>Total</b>		<b>1469 (79%)</b>	<b>387 (21%)</b>	<b>1856 (100%)</b>	<b>2176 (66%)</b>	<b>1126 (34%)</b>	<b>3302 (100%)</b>

\* includes occasional students

- In 2012, Prof Willie (W) Nicol, Department of Chemical Engineering, received the SAChE Innovation Award for achievements in the field of reactor technology. In the same year, Prof Derrick (D) Kourie, received the South African Institute for Computer Scientists and Information Technologists (SAICSIT) Award for the pioneering role he had played in promoting computer science as an academic discipline in South Africa.
- Prof Maharaj was the recipient of the Technology and Human Resources for Industry Programme (THRIP) Technology Award for research in 2013, in recognition of his research group's work on broadband wireless multimedia communications. He was also the recipient of the South African Institute of Electrical Engineers (SAIEE) Excellence Award for outstanding contribution in 2015.
- Three scientists in the School of Engineering presented public lectures as part of the Vice-Chancellor's Expert Lecture Series: Prof Majazi (May 2011), Prof Du Toit (May 2012), and Prof Maharaj (August 2013).
- Dr Hein (H) Badenhorst, Department of Chemical Engineering, was the winner of best paper at the 2015 South African Solar Energy Conference and was invited as a plenary speaker at the 2016 World Conference on Carbon, organised by the American Chemical Society. In 2016 he was also recipient of the Royal Society of South Africa Meiring Naudé Medal, awarded to outstanding early career scientists.
- Prof Gerhard (GP) Hancke, Department of Electrical, Electronic and Computer Engineering, was elevated to the status of an Institute of Electrical and Electronics Engineers (IEEE) Fellow, with effect from 1 January 2016, for his contributions to the field of wireless sensor networks.
- Three academics — Johann (J) Hager, Department of Mining Engineering; Prof Sarma (VSS) Yadavalli, Department of Industrial and Systems Engineering; and Prof Ronny (R) Webber-Youngman, Department of Mining Engineering — received a silver medal from the Southern African Institute of Mining and Metallurgy (SAIMM) for their paper titled, 'Stochastic simulation for budget prediction for large surface mines in the South African mining industry' (2015/2016).
- In 2016, Dr Jacomine (J) Grobler, Department of Industrial and Systems Engineering, received the JD Roberts Award for Emerging Researchers.
- Prof Kevin (K) Wall, Department of Construction Economics, received the South African Institute of Civil

Engineering (SAICE) Gold Medal Award for his outstanding individual contribution to the industry and profession in 2017, which constitutes the Institute's highest honour. In 2018, he received the National Science and Technology Forum (NSTF)-South32 Lifetime Award in recognition of his contribution to science and society.

- In 2017, Prof Tania (T) Hanekom, Department of Electrical, Electronic and Computer Engineering, received the Chancellor's Award for Teaching and Learning at the University's annual Academic Achievers' Awards function.
- In 2018, Prof Maharaj was elected as Junior Vice-President of the South African Institute of Electrical Engineers (SAIEE); and in the same year, Dr Hendrik (H) Prinsloo was elected as President of the Associated Schools of Construction of Southern Africa (ASOCSA).
- In 2018, Prof Meyer, was recognised as an A-rated researcher by the National Research Foundation (NRF). This increased the number of A-rated scientists in the Faculty to four — the others being Prof Xiaohua (X) Xia, Prof Andries (AP) Engelbrecht and Prof Brian (B) Rand. The number of NRF-rated researchers in the Faculty increased from 42 in 2009 to 77 in 2018 with a total of 32% of staff being NRF-rated by the end of this review period.

### Performance in overview

Between 2009 and 2018, the overall student numbers in the Faculty increased by almost a third (see [Table 4.1](#) on p. 151). The increase was mainly evident in the School of Engineering and in the number of black students, while the gender balance gradually improved, especially at the level of postgraduate students.

The infographic on pages 154 and 155 provides a composite view of performance across the four Schools that constitute EBIT:

- Enrolment growth was most marked with respect to black undergraduate and postgraduate students (as shown in [Table 4.1](#)).
- Undergraduate student success, measured as the modules passed, remained relatively constant, varying between 79% and 82%.
- The total number of students who completed their undergraduate qualifications from 2009 to 2018 were 10 925, of whom 3 653 (or 33,4%) were black.

- The number of students who completed postgraduate qualifications were 893 in 2009 which increased to 1 117 in 2018; in total, there were 10 954 graduates over this period, which includes honours, master's and doctoral qualifications combined.
- Master's and doctoral graduates were 3 363 and 363 respectively, of whom 57,8% were black.
- While the student to staff ratio doubled from 12,6 in 2009 to 26,8 in 2018, research output increased over the same period, from 184,31 publication units to 365,54. At the same time, the Faculty's weighted research output improved from 0,61 in 2009 to 1,64 in 2018.
- Also positive was the increase in the percentage of academic staff with PhDs — from 56% in 2011 to 68,8% in 2018 — and the increase in the number of NRF-rated researchers, from 42 in 2009 to 77 in 2018, four of whom were A-rated.

In 2018, the Faculty was listed in five knowledge fields in the Quacquarelli Symonds (QS) World University Subject Rankings:

- Engineering and Technology (375)
- Electrical and Electronic Engineering (301–350)
- Mechanical and Aeronautical Engineering (251–300)
- Chemical Engineering (251–300)
- Computer Science and Information Systems (401–450)
- Architecture was ranked in the top 200 architecture schools in the world (from 2016).

Finally, in terms of the International Science Index (ISI) Essential Science Indicators, EBIT's School of Engineering is ranked in the top 1% of engineering schools worldwide and is the highest-ranked School of Engineering in Africa.

**Prof Sunil Maharaj** | Dean, 2014–2018 and beyond



## EBIT: PERFORMANCE AT A GLANCE

### Enrolment and success

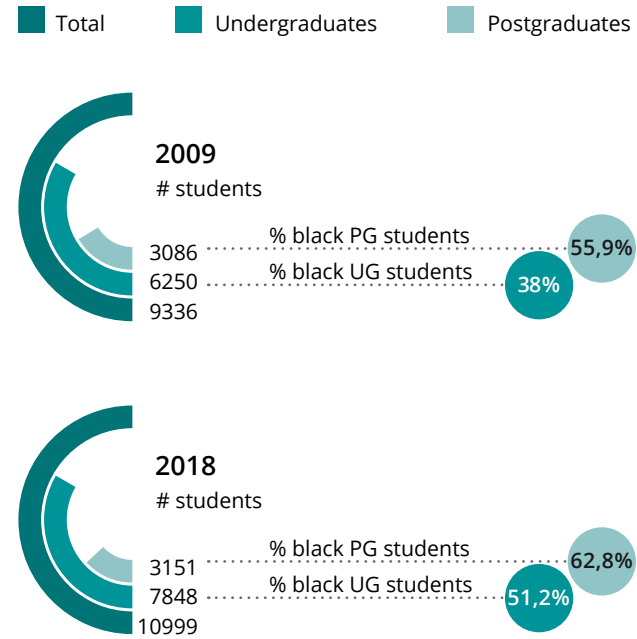

### Undergraduate module pass %

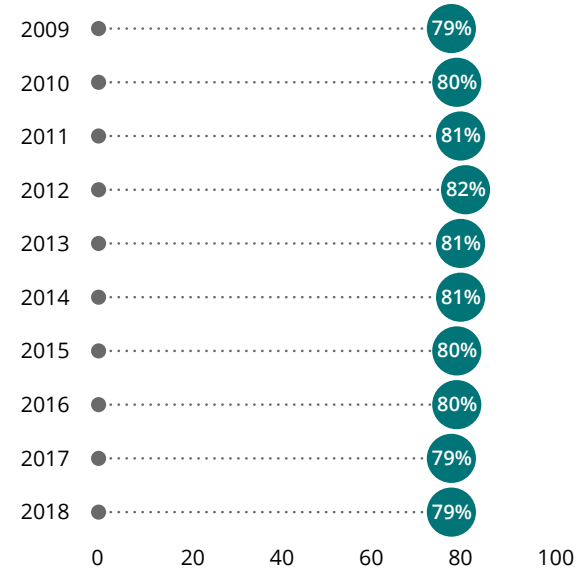

### UG graduates

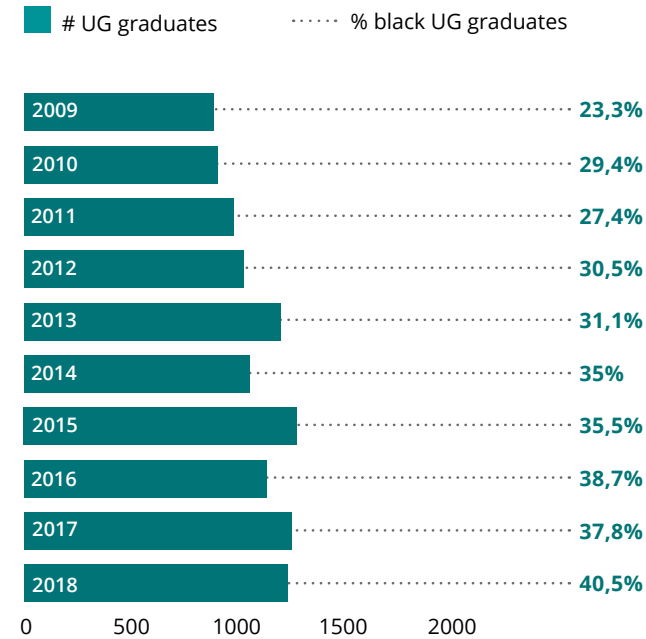

### Student : staff ratio

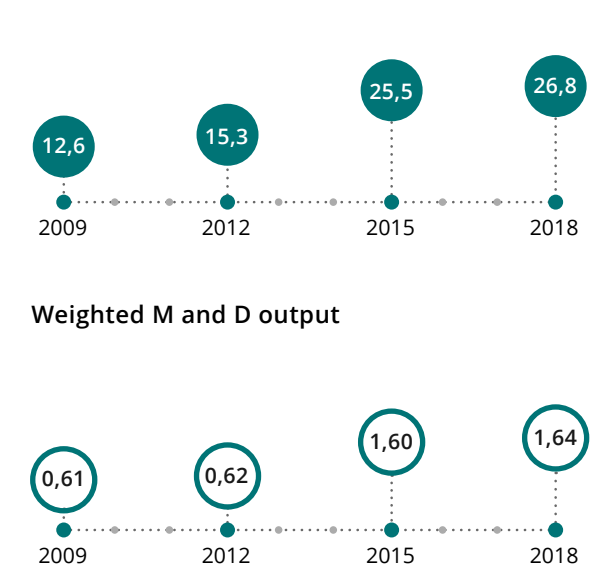

### Research pipeline

#### M and D enrolment

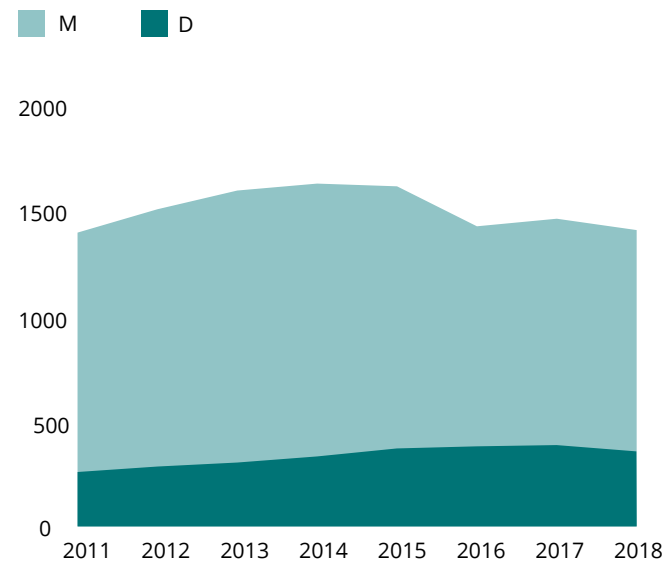

#### M and D graduates

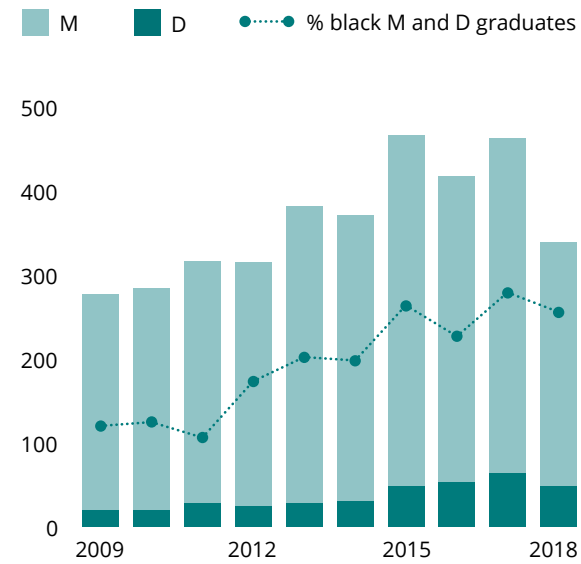

### Capacity and productivity

#### % Academic staff with PhDs

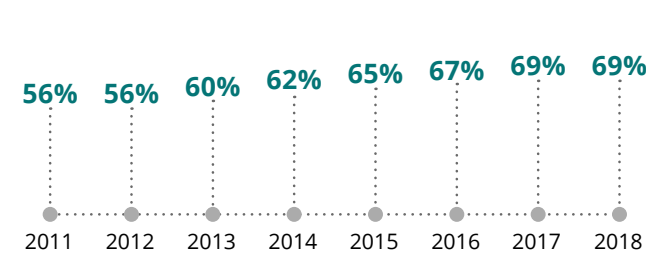

#### NRF-rated researchers, 2018



#### Research output

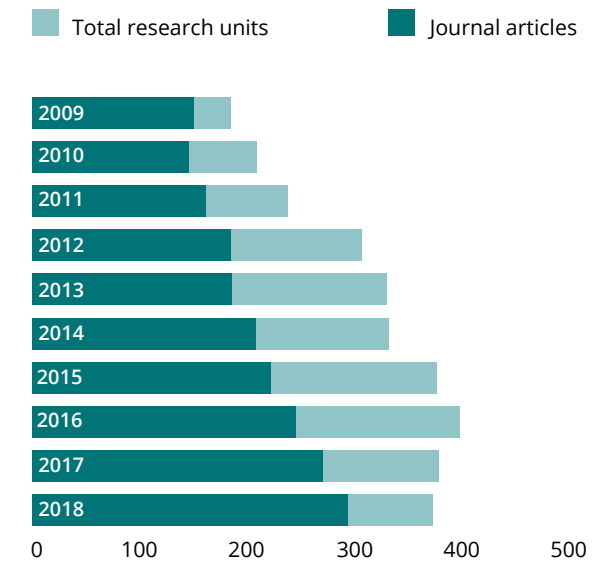



## SCHOOL OF ENGINEERING

Prof Josua (JP) Meyer was the Chair of the School for Engineering from 2009 to 2018. The School offered undergraduate and postgraduate programmes in Chemical Engineering; Civil Engineering; Electrical, Electronic and Computer Engineering; Industrial and Systems Engineering; Materials Science and Metallurgical Engineering; Mechanical and Aeronautical Engineering; and Mining Engineering. All the programmes in the School were successful in being fully accredited by the Engineering Council of South Africa (ECSA) in 2012, and again in 2017, which meant that all qualifications are internationally recognised for professional registration by all the signatories of the Washington Accord.

The School emphasised planned growth in student numbers in supporting industrial and economic development. It also endeavoured to strengthen its associations with industry and government to achieve alignment with these partners and to grow in research activities. The number of students enrolled in the undergraduate Engineering programmes grew from 4 014 in 2009 to 5 431 in 2018. This growth was made possible by the completion of the new Engineering 3 Building in 2011.

The Engineering 3 Building can accommodate more than 2 000 undergraduate students and more than 100 staff members and postgraduate students. This growth in student numbers was further supported with the inauguration of the Mining Industry Study Centre in 2013. The design made use of previously unused space beneath the Engineering 1 Building. It has 200 computers for individual work, 60 individual study cubicles and 30 discussion rooms that can each accommodate seven students for groupwork.

During the same period, the number of graduates increased from 1 049 to 1 429. Greater emphasis was placed on attracting students into the PhD programmes, which resulted in an increase in doctoral graduates from 11 in 2009 to 31 in 2018. This increased research capacity contributed significantly to the growth in scholarly publications, from approximately 100 articles in 2009 to 200 in 2018, which also shows the increase in research productivity as the number of staff stayed relatively constant.

The programmes in Engineering were aligned with international trends to create greater communality and reduce the overloading that developed in the programmes over time. The new curricula were phased in from 2008 over four years, from 2009 to 2012. Since 2012, smaller changes were made to almost all the programmes to ensure better alignment with the needs of industry and ECSA.

### 1. Chemical Engineering

Chemical engineering has been a key factor in enabling the conversion of crude oil, coal and gas into useful products like fuels and chemicals. In addition, many chemical engineers have remained actively involved in the minerals processing industry, where extraction of sought-after metals and other products in an economically feasible manner is the focus. Increasingly, chemical engineers use biotechnology to ensure a sustainable processing environment, which optimises the use of scarce resources like water and energy for future generations. To this end, many chemical engineers become specialist environmental engineers.

The Department of Chemical Engineering was officially established in 1960, with Prof Dawie (D) Schoeman as the first Head of the Department. The first graduates completed their studies in 1962. When Prof Schoeman became Dean of the Faculty in 1980, Prof Uys (U) Grimsehl took over as Head of Department. Prof Philip (P) de Vaal succeeded him in 2004.

During the period 2009 to 2018, a strong focus was placed on internationalisation, in addition to ensuring that the Department was well-positioned towards world-class research and research outputs in the following areas: Advanced Materials (including carbon, fluorine, polymers and clays); Bio-reaction and Biochemical Engineering; Environmental and Water Utilisation Engineering; Energy Systems; Modelling; Optimisation and Control; and Tribology — all with a strong emphasis on sustainability. This research was supported by a variety of highly sophisticated state-of-the-art analytical equipment, the replacement value of which would be more than R50 million.

The Department's laboratory facilities were refurbished and expanded considerably during a comprehensive upgrading project at a cost of more than R80 million, which was completed in July 2015. This enabled the Department to continue to play a leading role locally, in Africa and globally.

Annual bachelor graduates increased from seven in 1962 to just below 100 in 2018. At the end of 2018, a total of 1 743 chemical engineers had graduated from this Department. Also, some 1 000 honours, 270 master's and 50 doctoral degrees had been awarded since the inception of the Department.

In this period, formal agreements with universities included staff and student exchanges with the following universities:

- Eduardo Mondlane University, Maputo, Mozambique
- Institut Charles Gerhardt, Montpellier, France
- Leibniz Institute of Polymer Research, Germany
- Mälardalen University, Västerås, Sweden
- Martin Luther University Halle-Wittenberg, Germany.

Several staff members achieved notable research achievements in this period:

- Prof Thoko (T) Majozi, a former staff member, received the South African Institution of Chemical Engineers (SAIChE) Bill Neal-May Gold Medal Award for outstanding achievement and international recognition in 2010.
- Prof Willie (W) Nicol received the SAIChE Innovation Award for achievements in the field of reactor technology in 2012.
- Dr Hein (H) Badenhorst, senior lecturer in the Department at this time, was selected as third place winner in the 2015 GAP Green Innovation competition hosted by The Innovation Hub Management Company. He was also the winner of best paper at the 2015 South African Solar

Energy Conference and was invited as a plenary speaker at the 2016 World Conference on Carbon, organised by the American Chemical Society.

- Prof Brian (B) Rand, former incumbent of the SARChI Chair in Carbon Technology and Materials, received an A-rating from the NRF.

Prominent alumni from the Department over the review period included:

- Honey (H) Mamabolo, Chief Executive of Thebe Unico, a chemical manufacturer for the automotive sector and subsidiary of Thebe Investment Corporation, and one of the first three black female chemical engineering graduates of UP (Class of 2016).
- Zanele (Z) Mahlangu, a final-year student in the Department (Class of 2018) was the recipient of the prestigious Schwarzman Foundation scholarship for studies in 2020 abroad.
- Koketso (K) Mbewe, while still an undergraduate student, was one of only three young people selected to represent South Africa in Tanzania at the 2016 Mandela Institute for Development Studies (MINDS) Annual Youth Dialogue. She is now a fellow at the Institute, and a co-founder of the Youth Leadership Investment Network empowering young people between Grade 5 and university level with entrepreneurial skills, tackling three major pillars: leadership, health education and moral regeneration.

### Institute of Applied Materials

The Institute of Applied Materials (IAM) is an interdisciplinary materials research group at the University of Pretoria with participation from the departments of Chemical Engineering, Chemistry, Materials Science and Metallurgical Engineering, and Physics. Prof Walter (WW) Focke is the Director of the IAM. Highlights over the past 10 years focused on malaria vector control and the development of green pyrotechnics. Another area of research has included the use of nano-clays as a carrier of catalysts finding application in fast pyrolysis and the conversion of cellulose materials into synthetic oil — an approach conforming to many of the requirements for sustainable production.

IAM is a major partner in the UP Institute for Sustainable Malaria Control to combat malaria. A significant proportion of malaria infections in Africa may be due to exposure to vector mosquitoes during the early hours of the evening when people are still active outdoors. It has also been determined that over 90% of outdoor infective mosquito bites occur on

the ankles and feet. For this reason, people need to protect their ankles and feet while they are outdoors in a malaria-endemic area.

The IAM group also discovered a synergistic mixture of approved mosquito repellents that could provide a faster route to the public use of replacement repellents with fewer negative consumer perceptions such as high cost, odour, a high absorption rate, and oily feel or skin irritation. This discovery opened the way for the development of better mosquito repellent formulations based on azeotropic blends, which are sorely needed to fight mosquito-borne diseases such as malaria.

Green Chemistry is an initiative adopted globally by chemists and chemical engineers striving towards the sustainable manufacture of chemical products. It is underpinned by a philosophy that encourages the design, development and implementation of chemical products and processes that reduce or eliminate the use and generation of substances that are hazardous to the environment and human health.

The main focus of this research, which was done in collaboration with a leading industrial developer of commercial explosives for the mining and construction markets, was to find greener alternatives to lead and other heavy metal-based compounds currently in use in shock tube detonators. This includes lead-based primary explosives, as well as lead-based delay compositions.

### Chair in Carbon Technology and Materials

In 2006, the Department of Science and Technology (DST) awarded the University of Pretoria a Chair in Carbon Technology and Materials. The Chair provides postgraduate training and research services in carbon materials relevant to local carbon industries. Prof Ncholu (N) Manyala in the Department of Physics was the Chair during this review period.

### Chair in Fluoromaterials Science and Process Integration

The Department hosted the SARChI Chair for Fluoromaterials Science and Process Integration during the period September 2007 to August 2018, with industrial sponsorship from the South African Nuclear Energy Corporation SOC Ltd (Necsa) and its subsidiary Pelchem SOC Ltd. Prof Philip (PL) Crouse, a former research fellow at the University of Manchester, was the incumbent of this Chair in this period.

Apart from a considerable contribution to graduates at honours, master's and PhD-level, active contributions were made towards the Department's research outputs, predominantly in the disciplines of fluorine and nuclear chemistry and technology. In addition, a tetrafluoroethylene (TFE) production facility was developed, and UP became one of only two international universities with a polytetrafluoroethylene (PTFE) polymerisation and copolymerisation capability. The fluoropolymer legacy in the Department, supported by Department of Science and Technology (DST) funding, are PTFE recycling and product stream purification, as well as film casting for the production of architectural materials. A unique honours course was developed encompassing the full scope of fluorine chemistry and technology. The Chair co-organised the 1st South African Fluorine Symposium, held in Cape Town in February 2016, attended by several fluorine experts from as far afield as France, the US, Germany and Japan.

### Water utilisation and environmental engineering

This is one of the longest-remaining research focus areas of the Department. Headed by Prof Evans (EMN) Chirwa, this area grew in strength and, over time, the following industry-sponsored research chairs were established:

- Rand Water Chair in Water Utilisation Engineering
- East Rand Water Care Company (ERWAT) Chair in Waste Water Management
- Sedibeng Water Chair in Water Utilisation Engineering.

In water utilisation engineering, the primary focus has been on quality and treatment processes for and management of biological wastewater, industrial water and effluent, the disposal of slurries, sludges and solid water waste, and the production of drinking water. Environmental engineering research has focused on air quality management by assessing the impact of mining and power generation on ambient air quality on the highveld, alternative household energy supplies to reduce community air pollution exposure, and the reduction of gaseous and particulate emissions from the ferro-alloy industry. Various aspects of bioremediation and fermentation using natural organisms received attention.

### The impact of nano-materials on the environment

A relatively new area of research in the Department of Chemical Engineering is environmental nanotechnology, which examines the effect that nano-materials have on the environment. Understanding how the inherent physico-

chemical properties of engineered nano-materials and water chemistry influence and impact on ecology is studied using both experimental and modelling techniques.

Contributing to the research strength of the Department and the work of the research chairs and entities, two research groups provided support to the Department during this period:

- The Process Modelling, Optimisation and Process Control Research Group. In addition to more than 140 students who completed their studies with a postgraduate qualification in Control Engineering, the focus has been on the application of advanced control techniques to increase quality and throughput, process integration, and the minimisation of water and energy consumption through the use of novel optimisation techniques.
- The Energy Systems and Tribology Research Group. This is a multidisciplinary field of study aimed at limiting the wear on equipment by selecting the correct construction materials and by effective lubrication. The Tribology Laboratory provides an indispensable service to industry and is the only laboratory of its kind in the country. It is actively supported by industry and has a comprehensive series of test apparatus for investigating the performance of lubricants.

In recent years, sustainability and energy optimisation has received much attention. One of the specific areas of research includes research on lubricity behaviour of fuels, as part of a collaborative project between the departments of Chemical Engineering and Chemistry at UP.

## 2. Civil Engineering

Prof Elsabé (EP) Kearsley was Head of Department of Civil Engineering from 2007 until the end of 2015. She was succeeded by Prof Wynand (WJvdM) Steyn who started his first term as Head of Department in January 2016. During this period, several of the long-serving academic staff in the Department retired. This included Profs Walter (WMG) Burdzik, Nick (N) Dekker, Leon (L) Maree, Ben (BWJ) van Rensburg, Fanie (F) van Vuuren and Alex (AT) Visser. Some of these staff members had served for up to 40 years in the Department. Although they were still active in the Department after their retirement, their retirement as full-time staff allowed for a cohort of new staff members in the various disciplines to be appointed.

By 2018, the Department had four professors, six associate professors, two senior lecturers and six lecturers, as well as four administrative and twelve technical laboratory staff



Credit: Lucinda du Toit

members. 28% of the academic staff were female, and 17% African. The Department had 882 undergraduate and 200 postgraduate students, of which 51% were black and 27% were female, a major change in diversity since the previous reported period. It remained the largest Civil Engineering Department in the country. 92% of academic staff were registered professional engineers, 71% had PhDs, and there were four NRF-rated staff members and four members of the South African Academy of Engineering (SAAE). The Department retained its Engineering Council of South Africa (ECSA) accreditation during the 2017 ECSA visit.

Three Research Chairs were active during this period, the Transnet Chair in Railway Engineering, Rail Safety Regulator Chair and Rand Water Chair. All three chairs focused on advanced research and opportunities for postgraduate research and industry courses in their respective areas (see brief descriptions below).

The Department's strong research focus in structural, geotechnical, water and transport engineering grew during this period with active research for various governmental and private clients, both locally and internationally. Clients and collaborators originated from the United States, South America, Europe, Australia and China. This impacted in a growing publication record of the research conducted in the Department.

Two major developments in the Department during this period were the acquisition of a geotechnical centrifuge through an NRF grant, and in 2018, the initiation of the development and construction of Engineering 4.0 Phase 1. The geotechnical centrifuge has been used in fundamental and applied research for local and international clients and contributed to the research deliverables in this field. Engineering 4.0 is a new facility that was jointly sponsored by the South African National Roads Agency (SANRAL) and the University, with a focus on the development of a national roads' materials reference laboratory, training laboratory, concrete laboratory, accelerated pavement testing track and active traffic track. It is located on the Hillcrest Campus next to the N4 and the plan was for Engineering 4.0 to become part of the Innovation Africa at UP initiative upon completion in 2020.

Evolutionary improvements were made to the undergraduate and postgraduate programmes during this period. The improvements focused on preparing students for a fourth industrial revolution (4IR) environment where, while keeping fundamental training and concepts in place, students require more digital and communication skills to enable them to remain at the cutting-edge of their chosen profession.

### Transnet Chair in Railway Engineering

The Chair in Railway Engineering in the Department of Civil Engineering was established in 1996 when Spoornet (now Transnet Freight Rail) initiated a partnership between industry and the University. This partnership revolves around three major aspects: graduate training, continuing education courses for industry and railway research.

Prof Hannes (PJ) Gräbe was the incumbent of the Chair in Railway Engineering.

### Rail Safety Regulator Chair

The Rail Safety Regulator Chair was established in November 2016, when UP signed a memorandum of agreement with the Railway Safety Regulator (RSR). The partnership was the first of its kind in South Africa and was envisaged to take the country to a globally competitive level in terms of Future Smart Transportation.

### Rand Water Chair

The Rand Water Chair in Civil Engineering, with Prof Fanie (SJ) van Vuuren as the chairholder, was established in 2013, creating a partnership between industry and the University. The Civil Engineering Department has had a long-standing working relationship with Rand Water due to the expertise in the Department. This partnership has revolved around two major aspects: continuing education courses for industry and specific water-related research.

## 3. Electrical, Electronic and Computer Engineering

Three Heads of Department served between 2009 and 2018: Prof Wilhelm (FW) Leuschner was Head of Department until April 2011, when Prof Sunil (BTJ) Maharaj took over the reins. When Prof Maharaj was appointed as Dean of the EBIT Faculty in September 2014, Prof Gerhard (GP) Hancke served in an acting capacity until the appointment of Prof Johan (J) Joubert in January 2016. The Department continued to build on its proud history of producing excellent engineers in all three specialist disciplines of engineering offered by the Department — Electrical, Electronic and Computer Engineering.

During this period, all three undergraduate degree programmes were accredited by ECSA and were recognised as meeting the initial academic requirements for graduates to register as professional engineers in South Africa.

International recognition of these programmes was also granted under the Washington Accord.

When the Faculty of Engineering at UP was established in 1956, the first group of 64 students included a number who were admitted to study Electro-technical Engineering. Undergraduate student numbers in the Department continued to grow. With the completion of the Engineering 3 Building in 2012, new undergraduate laboratories were established. Two of the new undergraduate laboratories — Project Lab 1 and Project Lab 2 — were dedicated to final-year students for their design project.

Since 2012, the Robot Car Race Day has become an annual festive event where the Department's third-year students have the opportunity to demonstrate their accumulated skills after five semesters of engineering studies. Students must design, construct and test an autonomous robot vehicle to follow a track consisting of a criss-cross pattern of coloured lines. Industry involvement has also become an integral part of the race, with several local and international companies backing the effort by donating prizes and providing financial support to host the event.

The event was the brainchild of Prof Tania (T) Hanekom, who received a hat-trick of awards in 2015, based on her contribution to undergraduate teaching and learning: the Faculty's Teaching Excellence Award, the UP Innovation and Excellence in Teaching Award, and the Council on Higher Education (CHE)—Higher Education Learning and Teaching Association of Southern Africa (HELTASA) National Excellence in Teaching Award. In 2017, she received the UP Chancellor's Award for Teaching and Learning.

Postgraduate student numbers in the Department continued to grow and reached a peak in 2015. The increased focus on research and international collaboration during this period resulted in excellent growth in research outputs by the Department.

The research and postgraduate degree programmes were driven via the following research groups in the Department: Advanced Sensor Networks, Bioengineering, Control Systems, Electromagnetism, Electronics and Microelectronics, Energy Systems, Intelligent Systems, Power Systems, Telecommunications and Signal Processing.

The number of PhD degrees awarded by the Department is one way of measuring increased research activity. In 2018, a record number of 17 PhD degrees were awarded, compared to four in 2009. The number of accredited journal papers

authored or co-authored by academic staff increased from 42 in 2009 to 104 in 2018. According to the QS World University Subject Rankings, the University of Pretoria was ranked among the top 301–350 universities in the world in 2018, in the subject area Electrical and Electronic Engineering.

In 2010 Prof Xiaohua (X) Xia became the first academic in the Department to receive an NRF A-rating, which was renewed in 2016 for a second six-year term. Several academics in the Department received NRF B-ratings during this period: Prof Attahiru (A) Alfa, Prof Ian (IK) Craig, Prof Monuko (M) du Plessis, Prof Gerhard Hancke, Prof Johan Joubert and Prof Wimpie (JW) Odendaal.

The Department hosted the following Research Centres, Chairs, Hubs, Institutes and Laboratories, which are briefly described below: Centre of New Energy Systems (CNES), Centre for Electromagnetism (CEM), Telkom Centre for Telecommunication Engineering for the Information Society (CeTEIS), MultiChoice Chair in Machine Learning, SARChI Chair in Advanced Sensor Networks, CBI Chair in Power Electronics, Sentech Chair in Broadband Wireless Multimedia Communication, Exxaro Chair in Energy Efficiency, National Hub for Postgraduate Programme in Energy Efficiency and Demand-side Management, Carl and Emily Fuchs Institute for Microelectronics and the Smart Grid Laboratory.

The financial and other resources secured through these entities contributed greatly to the education of postgraduate students and the research progress achieved by the Department.

### Centre of New Energy Systems

The Centre for New Energy Systems (CNES) gained a reputation as a premier research institute in the area of energy management both nationally and internationally. It is the only centre of excellence in energy optimisation and standardisation. The Centre was renamed as Centre of New Energy Systems to stress its research expertise in energy systems and to continue keeping its leading position in the field of energy optimisation, management and standardisation. The mission of the Centre of New Energy Systems is to be a world-class centre of excellence that addresses the research, education, development, and industrial applications of energy optimisation and management.

Prof Xia remained in the leadership position as Director of CNES.



### National Hub for Postgraduate Programme in Energy Efficiency and Demand-side Management

The South African National Energy Development Institute (SANEDI), a subsidiary of CEF (Pty) Ltd, is a joint initiative of the Departments of Science and Technology (DST), and the Department of Energy (DoE). SANEDI has identified energy efficiency and demand-side management (EEDSM) as key research and development themes for South Africa.

The postgraduate programme in EEDSM was initiated as one of the targeted government-funded programmes to generate high-quality master's and doctoral graduates specifically trained to meet the needs of an expanding and sustainable energy industry in South Africa. The EEDSM Hub is hosted by the Centre of New Energy Systems (CNES) in the Department of Electrical, Electronic and Computer Engineering.

### Centre for Electromagnetism

The Centre for Electromagnetism, established in 1996, has focused on the replacement of the obsolete 18 GHz network analyser in the compact antenna test range.

The field of microwave and antenna engineering has been an area of specialisation in the Department for a long time. In 1986, the Electromagnetism Group, under the leadership of Prof Johan (JAG) Malherbe, was awarded the first Centre of Excellence by the then Foundation for Research Development. In 1990 the Electromagnetism Group received major impetus with the opening of the Compact Antenna Test Range for antenna and radar cross-section measurements. The facility was significantly upgraded in 2010 as a result of funds raised by the then Dean, Prof Sandenbergh.

This facility is unique as a university-owned research laboratory in the southern hemisphere, and enables the characterisation of antennas in the frequency range from 0.75 to 40GHz.

Prof Wimpie (W) Odendaal is the Director of this Centre.

### Telkom Centre for Telecommunication Engineering for the Information Society

The Centre for Teletraffic Engineering for the Information Society (CeTEIS) was inaugurated in collaboration with the University of the North as part of the Telkom Centre of Excellence programme in August 1997. Prof Christoff (C) Pauw was the first Director. The University of the North formed its own CoE in June 2004 (Automatic Speech Recognition) and, as a result, the formal partnership was concluded. The full name

of CeTEIS was changed to the Centre for Telecommunication Engineering for the Information Society in 2009.

Dr Jacques (J) van Wyk has remained the Director from November 2009 to beyond 2018.

### CBI Chair in Power Electronics

The CBI-electric Low Voltage Chair in Power Electronics was launched in 2012. The Chair, funded by the CBI-electric Group, supported staff, undergraduate and postgraduate bursaries and research project costs, initially for three years (2012/2013, 2013/2014 and 2014/2015). Additionally, CBI-electric low voltage Group also sponsored power electronics and electrical equipment, which students have used in their design project work.

Prof Michael (MN) Gitau was the chairholder from 2012 to 2013, and thereafter Prof Ramesh (R) Bansal until the completion of the CBI Chair in Electronics.

### Sentech Chair in Broadband Wireless Multimedia Communication

The SENTECH Chair in Broadband Wireless Multimedia Communication (BWMC) has participated in state-of-the-art research and has delivered world-class research and educational outputs for the benefit of SENTECH, the University and South Africa in general.

The SENTECH Chair has remained Prof Sunil Maharaj.

### Exxaro Chair in Energy Efficiency

The Exxaro Energy Efficiency Chair was initially established in June 2012 with a contracting period of five years. After its success in the first funding period, the Chair was renewed for another five years from January 2018 to December 2022. The chairperson, Prof Xia, is an NRF A-rated scientist and also the Director of the National Hub for Energy Efficiency and Demand-Side Management (EEDSM) and of the Centre of New Energy Systems (CNES).

Dr Lijun (L) Zhang, an NRF Y-rated scientist with expertise in industrial energy efficiency, was identified as Junior Chair until June 2019.

### Carl and Emily Fuchs Institute for Microelectronics

Carl and Emily Fuchs Institute for Microelectronics (CEFIM) has been active in the field of microelectronics research and specialist training since 1981. The research and postgraduate

programme is mainly in the field of integrated circuit design, especially the design of analog signal processors, RF circuits and optical receivers in CMOS technology. The simulation and modelling of circuits, devices and processing technologies are also investigated. The application of semiconductors as optoelectronic devices plays an important role in the activities at CEFIM.

International contact in microelectronics has remained vital and CEFIM lecturers and students often participate at international conferences and overseas experts visit the CEFIM facility regularly.

The Director of CEFIM is Prof Trudi (T) Joubert.

### SARChI Chair in Advanced Sensor Networks

The SARChI Chair is co-hosted by the Department's Advanced Sensor Networks (ASN) Group and the Meraka Institute at the Council for Scientific and Industrial Research (CSIR) under the digital@SERA partnership. The ASN Group is a leading hub of research and development in the field of ASN. It was established in 2005 by Prof Gerhard (G) Hancke and aims to be a focal point in the creation of a critical mass in this key field, partnering with local and overseas academic institutions, research organisations and industry.

The SARChI Chair, which was officially launched in January 2015, has formed a vital part of the activities of the ASN Group. It is headed by Prof Attahiru (A) Alfa, a professor of telecommunication systems in the Department of Electrical and Computer Engineering at the University of Manitoba (Canada), who has made a significant contribution to the research outputs of the Department of Electrical, Electronic and Computer Engineering at UP.

## 4. Industrial Engineering

Prof Sarma (VSS) Yadavalli was the Head of Department of Industrial Engineering (IE) between 2009 and 2018, having taken over from Prof Schalk (SJ) Claasen who moved to another division within the University in 2008. Under Prof Yadavalli's leadership, the Department made significant strides in many important areas of departmental activities, including teaching, research, staff development and industry relations.

The Department strengthened its teaching portfolios and maintained its accreditation with ECSA throughout this period. The Industrial Engineering programmes remained highly sought after in industry and the number of student

enrolments grew steadily — from 590 to 920 for the undergraduate cohorts while postgraduate numbers increased from 250 to 470 between 2009 and 2018.

The Department also increased the number of young lecturers and managed to put them on a research path that enhanced both the teaching and research capacity of the IE Department. By the end of this review period, the average age of academic staff was 40, and if the oldest were taken out, the average age would drop to 26. Of this generation of lecturers, 85% had their PhDs. This positioned the IE Department well for growth in research, and in the quality of programmes that exposed IE students to cutting-edge knowledge.

In pursuit of both research and teaching excellence, the IE Department identified main areas of research which included: business architecture, systems (and enterprise) engineering, applied optimisation and transport systems, manufacturing planning and supply chain management, supply chain engineering and health systems, stochastic processes and operations management, and finally, applied systems analysis and control. To give strength to these areas of research, IE postgraduate modules were redesigned along these core areas to train and absorb students into these areas of research, thereby integrating postgraduate teaching with research plans.

The effects of this critical rethinking of IE programmes were seen in the steady increase in postgraduate enrolment and publication outputs. The per capita publication of staff stood at 1,5. The IE Department remained committed to the transformation agenda of the University, and to attract and retain students and lecturers from designated groups. This was reflected in the changing profile of students and staff in the Department. The Department also strengthened its relationship with the industry and other disciplines and research entities at UP.

It has worked consistently with industry through an IE advisory board. As a result of this interaction, the IE Department has ensured that its offerings are in line with the needs and expectations of industry and what is typically expected of graduates entering the labour market. This board has been reconstituted many times over the years to benefit from the insight of diverse people across several industries, each time ensuring that people of calibre are included for quality advice.

The IE Department's annual projects event remained one of the fora that the Department has used to maintain its network with industry. The number of attendees of this event steadily increased from 200 in 2009 to 450 in 2018, with a continual

improvement in the quality of presentations over these years. The event includes final-year students, industry partners, parents and invited guests.

In 2013, the Department initiated a collaborative project, with EBIT's Department of Informatics, linked to the Enterprise Systems Education for Africa (ESEFA). The German government, in collaboration with the Systems Applications and Products (SAP), the Enterprise Resource Planning (ERP) software giant, funded this project. Since its inception, the project has been incorporated into IE's undergraduate training programmes. The Department also designated, as a learning and innovation hub for SAP, the full complement of its professional certification programme. It is registered with the SAP African User Group (AfSUG), which means that students have direct access to collaboration programmes and projects of SAP user companies in southern Africa. This network strengthens their future job prospects and relationships.

IE graduates have readily found employment within several industries, many becoming leaders of businesses, a testimony to the quality of the IE programmes.

Finally, and in brief summary, the Centre for Transport Development is a collaborative and multidisciplinary research group represented by the departments of Civil Engineering and Industrial and Systems Engineering. Colleagues in the Department of Industrial and Systems Engineering have focused on the modelling of large-scale transport systems using state-of-the-art agent-based simulations.

## 5. Materials Science and Metallurgical Engineering

In 2009, the Department of Materials Science and Metallurgical Engineering was led by Prof Madeleine (M) du Toit who remained in this leadership role until 2014, when Prof Waldo (WE) Stumpf took over the reins as Acting Head of Department. Prof Roelf (R) Mostert was appointed as the new Head of Department in 2015.

In the period 2009 to 2018, the Department of Materials Science and Metallurgical Engineering was the only one of its kind in South Africa. It offered integrated undergraduate and postgraduate programmes, which spanned the full spectrum of metallurgy, including minerals processing, hydrometallurgy, pyrometallurgy, welding engineering and physical metallurgy. In 2017, ECSA reviewed the undergraduate programme and

fully accredited the BEng (Metallurgical Engineering) degree, with no negative findings, recommendations or comments made. Consequently, the programme was recognised internationally under the Washington Accord.

Over this period, undergraduate student numbers remained fairly constant, with it being 220 in 2009 and 208 in 2018. While student enrolment remained constant, significant transformation and growth occurred in the number of undergraduate black students. In 2009, 62% of the undergraduate cohort was black and by 2018 this had increased to 82%. The female constituent remained relatively high throughout the period, with 49% female undergraduate students in 2009 and a slight drop to 41% in 2018. During the same period, postgraduate student numbers also remained high with 172 in 2009 and 159 in 2018.

The Department showed a strong research focus, with research activities in four key areas: Extractive Metallurgy (minerals processing and hydrometallurgy), Pyrometallurgy, Physical Metallurgy, and Welding Metallurgy.

In the years leading up to 2018, research in the field of extractive metallurgy was led by Prof Natasia (N) Naude (minerals processing) and Prof Roelf (RF) Sandenbergh (hydrometallurgy). Research in pyrometallurgy was undertaken under the leadership of Prof Andrie (AM) Garbers-Craig. Prof Waldo Stumpf was the leader of physical metallurgy research, with Prof Chris (PC) Pistorius managing research activities in welding metallurgy.

The Department enjoyed excellent industry support, with all the research programmes in the Department sponsored by industry. The Department's world-class research facilities were augmented by the involvement of the Industrial Metals and Minerals Research Institute (IMMRI), housed within the Department. In 2009, the Anglo American Chair in Pyrometallurgy was created, an entity which was still active in 2018 and produced high-level research. In 2011, the SAIW Centre of Welding Engineering was established, with sustained financial support throughout the period from the Southern African Institute of Welding (SAIW). In 2012, the Tenova Bateman Chair in Minerals Processing was established, leading to several postgraduate research projects being executed in the field of minerals processing. A year later, in 2013, the Glencore Chair in Pyrometallurgical Modelling with close links to industry was established.

What follows are brief descriptions of these entities.

### Industrial Metals and Minerals Research Institute

Established in 2001, the Industrial Minerals and Metals Research Institute (IMMRI) is funded by industrial partners to undertake contract research. It hosts leading experts in the metallurgical engineering industry. The strong industrial focus and project-based approach has provided leading research especially in the field of physical metallurgy, but the portfolio of the Institute does include work in other fields as well. It is well-respected by industry partners and hosts specialist equipment and research staff with years of experience in applying the relevant analytical techniques to their own research, but also to others — both in industry and in the academic environment.

The Director of the Institute is Prof Roelf (R) Mostert.

### Anglo American Chair in Pyrometallurgy

The establishment of the Anglo American Chair in Pyrometallurgy in 2009 was the precursor to formation of the Centre for Pyrometallurgy at UP. The Centre was officially launched on 30 May 2011 by Godfrey (G) Gomwe, Executive Director of Anglo American South Africa. The key aim was to strengthen expertise and perform internationally competitive research that is relevant to the local pyrometallurgical industry, thereby bringing the pyrometallurgy group at UP and the pyrometallurgical industry closer together.

The Centre is well-established with ongoing research in aspects of pyrometallurgy strongly focused on the needs of the South African pyrometallurgical industry. Modelling was the latest sub-discipline added as a field of focus at the beginning of 2013 with the establishment of the Glencore Chair in Pyrometallurgical Modelling.

Prof Andrie (AM) Garbers-Craig is the Head of the Centre.

### SAIW Centre of Welding Engineering

Established in 2011, the SAIW Centre of Welding Engineering has focused on research and postgraduate training of welding engineers and technologists. Welding engineering is a scarce skill, and the industry relies on graduates who are qualified and meet the requirements of the International Institute of Welding (IIW). The training programme of IIW is recognised by training and accreditation entities worldwide, such as the International Systems Organisation (ISO) and the European Committee for Electrotechnical Standardisation (CEN).

Prof Chris (PC) Pistorius is the Head of the Centre.

### Tenova-Bateman Chair in Minerals Processing

The Tenova-Bateman Chair in Minerals Processing was established in 2012. The key aim is to perform internationally competitive research that is relevant to the local minerals processing industry, thereby bringing the minerals processing research group at UP closer to the minerals processing industry in South Africa. The Chair was active for a three-year period, from 2012 to 2014, when the company was sold. Unfortunately, the new owners did not want to continue with the sponsorship of the Chair, which meant that research linked to minerals processing was absorbed by the Department of Materials Science and Metallurgical Engineering.

Prof Natasha (N) Naudé was the chairholder.

### Glencore Chair in Pyrometallurgical Modelling

Established in 2013, the Glencore Chair in Pyrometallurgical Modelling is closely linked to the needs of industry. The aim is to support industry with basic and applied research to promote knowledge transfer in the field of pyrometallurgical processes and related materials with a specific focus on the measurement and modelling of material physiochemical properties, computational thermochemical analysis, process modelling, multi-physics modelling and techno-economic modelling.

Dr Johan (J) Zietsman, an honorary academic staff member of the Department of Materials Science and Metallurgical Engineering, has remained in the position as Research Chair.

## 6. Mechanical and Aeronautical Engineering

Under the leadership of Prof Josua (J) Meyer as Head of Department, Mechanical and Aeronautical Engineering continued to reinforce its proud tradition of delivering excellent education to young mechanical engineers to excel in the conception, design, implementation and operation of mechanical and aeronautical systems. During the period 2009 to 2018, all the international rankings also showed an improvement in the Department's ratings. Article outputs increased significantly by approximately 125% from 20 to 45 units, which shows an increase in productivity as the Department's human resources had stayed constant.

In 2011, the Engineering 3 Building was taken into use, which helped to consolidate staff in three major hubs centred

around the main research streams in the Department. These hubs are in the Engineering 1, Engineering 2 and Engineering 3 Buildings respectively, while many of the large equipment laboratories remained in the Heavy Machinery Laboratory Complex. This was further supported by the new Mining Industry Study Centre in 2013.

This spatial arrangement served the Department well during the second half of the review period and provided logical growth paths for research conducted in the laboratories. The increase in laboratory and office space also made it possible to increase undergraduate graduates from 106 in 2009 to 250 in 2018, a growth of 135%. Similarly, there was a corresponding growth of 157% in postgraduate students. The headcount of all under- and postgraduate students increased by 76% from 1 090 to 1 920 students. The 2009 to 2018 period can therefore be characterised as a period of significant student enrolment growth in the Department.

In 2014, the Centre for Asset Integrity Management (C-AIM) was formally established and approved by Senate as a research centre under the leadership of Prof Stephan (PS) Heyns, to address national and international trends to optimise the life cycle management of physical assets. C-AIM consolidated previous activities in structural mechanics, dynamic systems and maintenance engineering into a broader asset-centred research stream with strong industrial links. C-AIM became the host of the Eskom Chair in Plant Asset Management, which was established in 2012 and became a major driving force in the C-AIM research agenda for the next decade. Through the Eskom Chair, which has been held by Prof Johann (J) Wannenburg from 2017, the Department has made significant and sustained contributions to the upskilling of the Eskom engineering workforce and addressed serious technical challenges in power generation asset management. This had particular relevance during a period of crisis in the history of South African power generation.

Various patents relating to steam turbine condition monitoring were internationally registered. C-AIM also hosted other Chair agreements with Rand Water, Weir Minerals and Exxaro during the review period.

The unique testing infrastructure in the *Laboratory for Structural Mechanics* continued to serve as a strong link to industry with many South African companies that used these facilities regularly for specialised test projects.

In 2011, Prof Schalk (S) Els established the *Vehicle Dynamics Group* (VDG) as a formal research group in the Department, with a strong focus on dynamics and mobility and funding

from local and international research and industry partners. During the period under review, VDG participated in various international exchange programmes, which served to establish high international visibility. The spatial reorganisation of the Department allowed VDG to develop a brand new vehicle dynamics laboratory which significantly reinforced the Department's international profile with state-of-the-art and unique vehicle suspension and tyre testing capabilities.

VDG also serves as the home for the University of Pretoria's participation in national and international Baja SAE® competitions.

Prof Meyer continued with his development of the highly successful thermoflow research activities of the Department and its transitioning into a new *Clean Energy Research Group* (CERG) during the review period. CERG has developed a range of world-class and unique experimental facilities, which are focused on enhanced heat transfer, transitional flow, micro channel condensation, optimisation with constructal theory and nanofluid characterisation. The group has very well-established research ties with scholars at École Polytechnique Fédérale de Lausanne (EPFL, Switzerland), Massachusetts Institute of Technology (MIT, US), Ghent (Belgium), Edinburgh (Scotland), Duke (US) and National Institute of Applied Sciences (INSA) (Toulouse, France). The experimental capability is reinforced with a computational fluid dynamics programme, which also focuses on concentrated solar receiver development and collector field optimisation. Confirmation of the exceptionally high quality of the research that is conducted in this group was obtained by the recognition of Prof Meyer as an internationally recognised leader as an NRF A-rated scientist in 2017.

## 7. Mining Engineering

Prof Ronny (R) Webber-Youngman served as Head of Department of Mining Engineering for the duration of the period under review and beyond. Under his leadership, the

In the mid-1980s the Department of Mechanical and Aeronautical Engineering commenced research in various fields related to physical asset integrity. This included structural fatigue testing, experimental modal analysis and vibration monitoring. Maintenance-related initiatives were subsequently launched, culminating in the establishment of a Centre of Excellence in Maintenance Engineering in 2008, with industry support from Sasol, Eskom, Exxaro and Anglo American. In 2012, Eskom established a Specialist Centre for Plant Asset Management as part of the Eskom Power Plant Engineering Institute (EPPEI) initiative, with a research focus on asset integrity management. This was followed by the establishment of the Rand Water Chair in Mechanical Engineering, as well as a cooperation agreement with Weir Minerals to establish a research focus on machine condition monitoring.

Department intentionally and visibly aligned its educational and research objectives with industry needs. A highlight for the Department was its celebration, in 2011, of 50 years of providing the mining industry with world-class leaders.

The Department maintained its core full-time academic and support staff, who were complemented by contracted industry experts as part-time lecturers. Its postgraduate research programme benefited from the involvement of Prof Con (C) Fauconnier as honorary professor and Profs Bharath (B) Belle, Jan (JJL) du Plessis, John (JAL) Napier and William (W) Spiteri as extraordinary professors. The financial contribution of the Minerals Education Trust Fund (METF), in the form of a staff salary subvention, enabled the Department to attract high-quality lecturers from industry.

A steady increase in student enrolment was witnessed from 2009. However, in 2015, following a slump in mining student numbers worldwide, the Department took a strategic decision to reduce its first-year intake in alignment with the decreasing demand worldwide, together with current trends in the South African mining industry. The decision was to cap its undergraduate student capacity at 150 students, which would include 40 final-year students. At the same time, the Department increased its focus on postgraduate enrolments, aiming to have 100 postgraduate students by 2025. By the end of the period under review, it had 184 undergraduate and 51 postgraduate students.

The Department's excellent relationships with its industry partners led to the establishment of the Kumba Virtual Reality Centre for Mine Design (VRC), which was made possible through an R18,8 million investment over three years by Kumba Iron Ore in 2013. This was the first centre of its kind in Africa to be housed at a university and enabled the Department to simulate a range of mining functions in a low-risk, high-impact learning environment. The facilities comprise a wall-to-wall 3D theatre, as well as an immersive mine simulation theatre, which casts 360° images against dark surrounding panels with cinematic clarity and highly realistic sound effects. The development, which was completed in



Kumba Virtual Reality Centre for Mine Design

2015, included new offices for the Department on the fifth floor of the Mineral Sciences Building, while African Rainbow Minerals provided funding for a new mining exhibition centre.

The Department developed innovative teaching and learning initiatives during this period, which were particularly aimed at supporting undergraduate students and enhancing the Department's throughput and success rates while ensuring that well-rounded mining engineers are developed. Industry visits form part of the Department's curriculum and serve to expose students to what they can expect when they start working at a mining operation.

An initiative to develop the non-technical 'soft skills' of students — the Sasol Engineering Leadership Academy — was developed in 2013 to assist graduates to adapt to the challenges of the world of work. It incorporated all the engineering disciplines but was limited to 50 students. When Sasol's sponsorship of this initiative ended, the Department launched a similar initiative exclusively for final-year Mining Engineering students, known as the Mining Engineering Leadership Academy (MELA). It was funded

from the Department's third-stream income and focused on the development of leadership and communication skills, as well as conflict resolution, problem-solving and stress management skills. The programme was presented by Dr Johann (J) Uys, a senior lecturer in the Department and an industrial psychologist with decades of leadership development experience in mining and related industries.

Another initiative to support students to succeed academically is the English literacy training drive, which was launched in the Department in 2014. This was developed following the identification of students' mastery of the English language as one of the challenges that affected their academic performance since only 13% of the Department's students have English as their first language. Undergraduate students receive assistance with writing, communication and presentation skills, and an English tutor provides feedback on their assignments to improve their English writing.

An important focus of the Department has been the well-being of its students. Its interaction with its students has taken place according to a value-driven framework, guided

by the values of respect, care, honesty, integrity and trust. In this review period, mining engineering students were given the opportunity to network and socialise with other students and staff of the Department outside lecture halls through the Tuks Mining Society, a student organisation that supported students. A mentorship programme was in place where junior students were assigned senior students to assist them with academic issues and provide guidance based on personal experience.

The Department continued to benefit from the expertise of leaders from industry and academia, who serve on the Mining Engineering Advisory Board. The Department also enjoyed the active support of its alumni through the Mining Alumni Society of the University of Pretoria (MASUP). Through this platform, alumni supported the Department by raising sponsorships and ensuring that a high level of skills and educational standards were maintained. This society also served as a social network for mining engineers in industry.

The Department's alumni are among the captains of industry locally and abroad, and in this period included more than 30 individuals who served in the leadership ranks of prominent organisations and on their boards of directors, recognised for the role they have played in the development of the country's economy. These individuals are also champions for the University of Pretoria and enhance its image through their exceptional achievements as the chief executive officers, chief operating officers, managing directors and executive heads of various mining companies.

The establishment of four industry-funded research chairs during the period under review enabled the Department to expand its research focus:

- **The Sasol Chair in Mine Safety, Health and the Environment** was established in 2012 to advance teaching and research in the field of safety, health and the environment as it pertains to the mining industry.
- **The Mining Resilience Centre**, established in 2017, forms part of the Sasol Chair in Mine Safety, Health and the Environment, and is in collaboration with the Department of Materials Science and Metallurgical Engineering.
- **The Harmony Gold Chair in Rock Engineering and Numerical Modelling** was established in 2013 with support over three years to research a safer working environment in the hard-rock mining industry. In 2016, Harmony Gold extended its initial sponsorship by a further three years.

- The AEL Intelligent Blasting Chair for Innovative Rock-breaking Technology was established in 2018 to establish the University as a centre of excellence for emerging rock-breaking technologies. It would make use of the VRC to focus on three-dimensional blast simulation and the visualisation of new research.

### Sasol Chair in Mine Safety, Health and Environment

The focus of the Sasol Chair in Mine Safety, Health and Environment is on improving the health and safety performance of the mining industry and is directed at managers in the mineral resources industry. A comprehensive online programme has been designed, exclusively for the mineral resources sector and covers critical issues related to safety, health and the environment. By improving their knowledge and application ability, the programme enables mine managers to move from being reactive and compliant, to becoming resilient in issues regarding safety, health, the environment and community management.

The establishment of this Chair has also created new research opportunities, including a noise-induced hearing loss research project. This project is aimed at reducing the noise exposure associated with a scrubber, which is mounted onto a continuous miner.

### Harmony Chair in Rock Engineering and Numerical Modelling

Mining at depth or mining highly stressed areas commonly occurs in the South African gold mining industry due to the age of operations and the extent of mining conducted over the past century. The safety concerns related to mining these areas, especially in terms of seismic activity, have the potential to limit future gold production unless methods are found to select and manage mining within acceptable risk levels. The Harmony Chair in Rock Engineering and Numerical Modelling conducts research into rock engineering, specifically the impact of mining sequences and mining rate on seismic activity in deep-level mines or highly stressed areas such as remnants or shaft pillars. This research was initially focused on seismic and mining-related parameters that have historically been used to measure the risk involved in mining these areas. The ultimate aim is to search for more appropriate parameters and even methods of determining these parameters. This will include the use of numerical modelling packages and the potential to develop a constitutive law that could simulate strain softening, or a stress drop in areas where stress fracturing has occurred, normally ahead of the mining faces.

The research conducted forms part of individual postgraduate study programmes under the leadership of Prof Francois (DF) Malan and Prof John (JAL) Napier, both renowned specialists in the field of rock engineering.

### Mining Resilience Research Centre

Linked, and in recognition of the particular relevance to Africa, the Department launched the Mining Resilience Research Centre (MRRRC) in 2017. This is a multidisciplinary research centre that contributes to solutions for complex mining problems through the rigorous integration of scientific research, the pursuit of practically implementable solutions and the education of graduates who are equipped with relevant skills. It engaged in several collaborative contract research projects for industry during the review period.

Prof Francois Malan, who had served as an extraordinary professor in the Department since 2010, was appointed in a full-time capacity as the Director of the Centre in 2018.

### The AEL Intelligent Blasting Chair

Established in 2018, the AEL Intelligent Blasting Chair channels the support of AEL Intelligent Blasting (AEL) into new technologies that benefit the research capabilities of both the funder and the Department. In the process, the research partnership has allowed AEL to exploit the University's virtual reality (VR) and augmented reality (AR) expertise and facilities. These visual technologies can be applied in several areas, such as the training of AEL personnel and other stakeholders, and the 3D scanning of mine environments, which would enable analysis and visualisation in an immersive, virtual setting. Through the sharing of the expertise of AEL and the Department of Mining Engineering, the Chair has supported ground-breaking projects that address pressing issues within the mining industry.

The chairholder is Prof William (W) Spiteri.

## SCHOOL FOR THE BUILT ENVIRONMENT

Prof Tinus (MJ) Maritz was Chair of the School for the Built Environment between 2008 and his retirement in 2018, after which Prof Chrisna (C) du Plessis from the Department of Architecture took up this position.

The School, through its departments of Architecture, Construction Economics, and Town and Regional Planning, offers seven professional programmes: Architecture,

Landscape Architecture, Interior Architecture, Town and Regional Planning, Quantity Surveying, Construction Management and Real Estate. These programmes are all recognised by their respective professional bodies and are highly regarded by the professions and prospective employers.

While the number of students in the undergraduate programmes remained relatively stable due to limitations on intake, the postgraduate student body in both research and coursework programmes grew substantially. During the period under review, approximately 1 778 honours, 2 762 master's and 238 doctoral students were enrolled in the School for the Built Environment.

Research activities in all three departments increased significantly, and important international links and local stakeholder and industry partnerships were established.

Of note was the progress made in terms of demographic transformation. More than 50% of academic staff were female, and the majority of students in the School were now black and female.

## 1. Architecture

On 1 March 2018, the Department of Architecture celebrated its 75th anniversary. Reflecting on the past three-quarters of a century, it is clear that the Department had established and maintained a clear identity rooted in context and local heritage, respect for the natural environment and commitment to sustainability, and recognition of the duty of architecture and design to create a socially responsible and responsive built environment. This baton had been passed from one Head of Department to another, with each bringing an individual but complementary flavour to the mix. In 2009, Prof Karel (KA) Bakker took over the position from Prof 'Ora (O) Joubert. He built a very strong research programme focused on the shared heritage of both colonial and African-built heritage and urban and architectural conservation. At the end of 2014, the Department took permanent leave of Prof Bakker who passed away after a long struggle with cancer. Emeritus Prof Roger (RC) Fisher took on the position of Acting Head of Department for the fourth time, before handing over the reins to Prof Chrisna (C) Du Plessis in October 2015. Prof Du Plessis was appointed for a second term in 2019.

The period between 2009 and 2018 saw extensive staff turnover as personnel returned to private practice, emigrated, took up positions at other local and international universities, retired, and in the case of Prof Bakker and

landscape architecture lecturer Fourie (F) Pieterse, passed away. At the same time, the professional landscape and the priorities of the University saw significant changes, with digital technologies and green and sustainable buildings growing in prominence in practice, and the University's growing emphasis on research challenging accepted modes of teaching and practice within the Department. The mainly young and enthusiastic new team embraced these changes to renew and revitalise existing research focus areas in heritage, environmental potential and human settlements and expand these into new areas such as urban citizenship, urban resilience and regeneration, and smart cities in collaboration with international universities, local NGOs and communities, as well as local government partners.

The Department continued to be a leader in architectural research and postgraduate education in the country. From 2016 to 2018 it was ranked in the top 200 architecture schools in the world, according to the Quacquarelli Symonds (QS) World University Rankings. In 2016, Emeritus Prof Fisher received a C2 NRF rating and Dr Ida (CA) Breed a C3 rating, and in 2018, Prof Du Plessis received a C1 rating. In the period between 2009 and 2018, the Department also produced 10 PhDs and published three books, all three receiving national awards:

- In 2016, *Eclectic ZA Wilhelmians: A shared Dutch built heritage in South Africa*, edited by KA Bakker, NJ Clarke and RC Fisher, received a SAIA Award of Excellence.
- Also in 2016, *Designing for Hope: Pathways to Regenerative Sustainability*, co-authored by C du Plessis and D Hes, won the AfriSam-SAIA Award for Innovation in Sustainability (Research Category).
- In 2018, the book *NZASM — footsteps along the tracks* by RC Fisher and NJ Clarke, won the Corobrik-SAIA Award for Excellence.

Students and alumni of the Department also excelled in local and international competitions. Two of our alumni won the prestigious *LafargeHolcim Sustainable Construction Next Generation* award for the Middle-East Africa Region with amended postgraduate student projects: Calayde (C) Davey in 2011, and Heidi (H) van Eeden (now Boulanger) in 2017; and in 2014, Van Eeden was placed third. That alumni from the Department won or were placed in three of the five competition cycles is a testament to the world-class grounding the Department provides in sustainable design. Students of the Department have also won more national *Corobrik Architectural Student of the Year* awards than any other architecture school in the country.



In 2017, the Department temporarily moved to the Groenkloof Campus to enable an extensive refurbishment of the Boukunde Building to make it compliant with contemporary building codes in terms of accessibility, fire and energy efficiency. State-of-the-art audio-visual systems, high-speed Wi-Fi coverage, and the refurbishment and upgrade of the Digital Design Lab created a building ready for the digital requirements of teaching and practising architecture. New lighting and improved daylighting in the studios, as well as a new reading room, provide better social learning spaces and working conditions for students, while upgraded archive infrastructure now provides a working space for students and visiting researchers that does justice to the most comprehensive architectural archive collection in the country.

The Department has continued to evolve and reinvent itself to remain relevant while staying true to its ethos that the role of the designer is to co-create a better future for the environments and societies within which they work while honouring the diverse legacies that shaped the present and preparing for the challenges of the future.

### Unit for Urban Citizenship

In 2017, the Unit for Urban Citizenship (UUC) was established in the Department of Architecture following successful inter-faculty collaboration with Foundation Programme students registered at the Mamelodi Campus. Current collaboration with communities and other stakeholders in several neighbourhoods in the City of Tshwane offers a living laboratory for integrated outreach, as well as research and teaching in both undergraduate and postgraduate programmes under the leadership of Dr Carin (C) Combrink.

The Unit is intended as a platform for embedded participation. The mission of the UUC is to develop the scholarship of civil engagement and participatory development within the context of a complex emergent African urbanism. It also seeks to embed a culture of responsible and collaborative urban citizenship in UP graduates and the communities within which they work. The Unit has become a vehicle through which collaborative community engagement work can be developed and researched.

## 2. Construction Economics

During the review period, the Department of Construction Economics bid farewell to Prof Tinus (MJ) Maritz, who was the Head of Department from 2007 to 2017. Prof Maritz was

employed for 42 years in the Department of Construction Economics and handed over the reins to Prof Benita (B) Zulch. The Department lost and gained excellent lecturers during this period, one of whom was Prof Chrisna (C) du Plessis who left the Department in 2015 when she took up the position of Head of Department of Architecture.

The Department endeavoured to build strong relationships locally and internationally with partners in the construction industry. During this review period, the Department was affiliated with the South African Council for the Quantity Surveying Profession (SACQSP), the Royal Institution of Chartered Surveyors (RICS), the South African Council for the Project and Construction Management Professions (SACPCMP), the South African Council for the Property Valuers Profession (SACPVP), as well as the Chartered Institute of Building (CIOB). In 2017, the CIOB confirmed their 5-year international accreditation of the Department's Construction Management programme.

The Department also maintained a strong relationship with industry and relevant professional associations, such as the Association of South African Quantity Surveyors (ASAQS), the South African Council for Shopping Centres (SACSC) and the Australian Institute of Building (AIB).

In 2015, a memorandum of understanding was signed between the University of Pretoria and the AIB. This memorandum aimed to establish close cooperation between the two organisations to enhance professionalism between building contractors, construction managers, academics and graduates within the South African and Australian construction industry. Prof Zulch continued with this partnership when she visited the AIB in 2019.

Staff members obtaining PhD degrees have always been one of the Department's most significant achievements. Doctoral degrees completed in this period included Prof Hoffie (H) Cruywagen (2015), Dr Hendrik (HF) Prinsloo (2016), and Dr Hennie (HHG) van Heerden (2018). Prof Cruywagen engaged in industry-relevant research on a tender price index for the local building industry, and also established a research partnership with RLB Pentad. Dr Prinsloo's research, in turn, related to the decision framework of construction delay claims, while Dr Van Heerden focused on research related to 'soft skills' in construction management, specifically the profile and skill set required.

Staff members, in collaboration with industry partners, also produced substantial publications for industry's use. In partnership with the Association of South African Quantity Surveyors (ASAQS), staff in the Department contributed to

the publication, *Standard System of Measuring Building Work, 7th Edition, Illustrated and Explained* (2017). The contributing authors were Prof Thys (T) Siglé, Prof Tinus Maritz, Prof Hoffie Cruywagen, Inge (I) Pieterse, Danie (D) Hoffman and Elzane (E) van Eck.

Danie Hoffman, in collaboration with the ASAQS and the Green Building Council South Africa, also published *Green Building in South Africa. Guide to Cost and Trends* (2016). Mr Hoffman received an award from the ASAQS for his extensive work towards producing this publication.

In this period the Department established strong relationships for teaching and research. Prof Chris (CE) Cloete had been involved with the South African Council of Shopping Centres (SACSC) for many years. A partnership between the SACSC and the Department of Construction Economics resulted, in 2016, in the founding of a *Chair in Shopping Centre Studies*. This partnership, headed up by Prof Cloete, was the first of its kind in South Africa. The partnership and Centre provided students with the opportunity to produce pioneering research.

In addition, the option to specialise in shopping centres was introduced in the BSc(Hons) and MSc in Real Estate programmes in 2017.

In 2016, Dr Michelle (M) Burger attended the 2016 Psychology in Construction workshop (Psycon) at the University of Wolverhampton (UK), which laid the foundation for collaboration between the two universities. Dr Ezekiel (E) Chinyio, founder of Psycon, and Dr Burger worked on possible funding opportunities and the hosting of similar Psycon workshops in Africa. Students also had the opportunity to gain exposure to the construction industry abroad. Since 2015, some Construction Management students had the opportunity to go on annual study tours where they could experience international construction methods and trends. Study tours included Singapore, Taiwan and Malaysia.

In addition to the overall academic and research achievements of the Department, individual achievements of staff members were celebrated. Prof Kevin (K) Wall, an extraordinary professor in the Department, received the South African Institute of Civil Engineering (SAICE) Gold



Medal Award for his outstanding individual contribution to the industry and profession in 2017. At the time, the award had been conferred on fewer than two dozen people since its inception nearly 70 years ago. In 2018, Prof Wall received the NSTF-South32 Lifetime Award in recognition of his contribution to science and society.

In 2018, the programmes offered in the Department — Quantity Surveying, Construction Management and Real Estate — underwent an extensive review. Innovation modules were re-evaluated, reconsidered and streamlined to deliver a new curriculum that was aligned with contemporary industry requirements.

The partnership between the University and the SACSC also brought about the opportunity to offer an honours degree in Real Estate in Retail Property, following on the MSc Real Estate in Retail Property degree introduced in 2017.

In 2019, the Quantity Surveying programme would celebrate its 99th birthday, an important milestone in the Department's focus on excellence in teaching and learning, research and industry collaborations.

### 3. Town and Regional Planning

Rapid urbanisation and a growing and increasingly younger population have provided South Africa with major opportunities, while at the same time placing ever-expanding and ever-more complex demands on government services, officials, facilities and finances. A greater awareness of and deeper concern with climate change further drove home the urgency of dramatically adjusting our way of building settlements, making a living and moving around. Together with this, the challenges of addressing the persisting and bitter legacies of the past, within a government structure that was also only just beginning to find its feet, have provided for interesting, exciting and challenging times for anyone in the fields of urban, rural and regional development planning.

Town and Regional Planning education at UP dates back to the year 1959 when a postgraduate programme in the discipline was introduced in the then Department of Land Surveying. A graduate programme followed in 1969. In 1998, the Department, together with the departments of Architecture and Construction Economics, became part of the School for the Built Environment in the Faculty of Engineering, Built Environment and Information Technology. Today it is one of the largest planning schools in South Africa.

Prof Mark (MC) Oranje has been at the helm as Head of Department from May 2001 onwards.

The Department has had between four and six permanent staff members and five to seven part-time members. In 2009, Prof Karina (K) Landman and Dr Johnny (J) Coetzee joined the Department as Senior Lecturers, and in 2014, Dandalene (D) Robinson joined the Department as Departmental Secretary. Together with Dr (now Prof) Jacques (J) du Toit (Senior Lecturer, now Associate Professor) and Prof Oranje, this team stayed the same until 2017, when Dr Kundani (K) Makakavhule joined the Department as Lecturer.

The Department took on and flourished in the process of:

- Providing the country with graduates that could individually and in teams plan for and drive the necessary multiple and complex changes
- Initiating, undertaking and reporting on research to provide credible evidence and knowledge, and
- Providing expert contract research and consulting services in several strategic government legislation, policy, strategy and framework preparation and review processes.

The Department's research focus was not only to expand its research output but also to diversify its focus. Papers were presented at conferences throughout the world; books and contributing chapters to books published, and papers in both local and international journals. Further, the move into transdisciplinary research involved researchers from fields such as Theology, Law, Social Work, Sociology and Anthropology, and topics ranging from adaptive and resilient settlement design, intergovernmental planning, the ethos and spirit of planning, local economic development, national planning, mining and its interface with government and local communities, and the process of becoming and being a planner.

Towards the end of the decade, the Department branded its broad area of focus as Spatial Revolution 4.0, with its stated intention as reimagining the spatial futures of South Africa and other African countries. Due to growing student numbers and the desire to undertake research in these domains, the Department was able to engage in and take on its more diverse offering.

In the area of contract research and consulting, the Department was, among others, appointed to assist with:

- The preparation of Regulations for the new Spatial Planning and Land Use Management Act, Act 16 of 2013 (SPLUMA), the Gauteng Rural Development Plan and the National Spatial Development Framework, both the first of their kind in the country.

- The Municipal Spatial Development Frameworks in the Northern Cape and Mpumalanga provinces.
- The revised 2030-Gauteng Spatial Development Framework.

The Department also:

- Undertook research into mining towns and local and regional economic development impacts
- Introduced a cross-boundary regional development planning ethos and competence to municipal planning and planners, which also included extensive capacity-building, and
- Provided research, facilitation and impact-assessment support in the preparation of new legislation and policy in the area of land reform.

Finally, the Department underwent a decisive change in profile, with the appointment of two new black female lecturers, both of whom should complete their PhDs within the next year or two. As such, the Department, with its six permanent lecturers, now consisted of three female lecturers (50%) and two black lecturers (33%). While there is still a long way to go, the Department has made steady progress on the crucial road of transformation.

The greater diversity of staff has also allowed the Department to connect even better with its students, and to deepen and strengthen its emphasis on students as co-producers of knowledge. The focus is on using the diversity in epistemologies that Planning as discipline requires, and in so doing, to transform the curriculum on an ongoing basis. At the same time, research is initiated and embarked on that speaks to the many and pressing needs of the country and the continent, and provides credible avenues for harnessing the vast potential of both.

## SCHOOL OF INFORMATION TECHNOLOGY

The School of Information Technology had two Chairpersons during this period — Prof Theo (TJD) Bothma (2008–2016) and Prof Archie (AJ) Dick (2017–2019). The three departments in the School — Computer Science, Informatics and Information Science — benefited from close links and collaborative research.

While undergraduate student numbers remained relatively stable in this period, postgraduate student numbers increased

to 1 996 honours, 2 319 master's and 724 doctoral candidates by the end of 2018. A new master's degree in Information Technology (MIT) in Big Data Science was established in January 2018, in the Department of Computer Science. Each of the three departments now had a coursework master's degree in Information Technology.

Research activities increased significantly in all three departments and important international links were established. In 2018, the School of Information Technology contributed 61,57 research units to the University, which is 21% of the total research output units of the Faculty.

### 1. Computer Science

This was a rewarding period for the Department of Computer Science as it went through various constructive changes. Prof Andries (AP) Engelbrecht served as Head of Department from September 2009 to August 2017. Prof Nelishia (N) Pillay joined the Department as the new Head of Department in September 2017. During this period, Prof Engelbrecht was appointed as Director of the Institute of Big Data and Data Science, and Prof Jan (JHP) Eloff as Deputy Dean: Research of the EBIT Faculty.

Staff members were appointed to various research chairs. Prof Engelbrecht was appointed as the DST-NRF SARCHI Chair in Artificial Intelligence; Prof Eloff, the DRS Cybersecurity Chair; Dr Vukosi (V) Marivate, the ABSA Data Science Chair; and Prof Pillay, the MultiChoice Joint Chair in Machine Learning.

Four staff members in the Department obtained their PhDs.

The Department featured on the QS World Ranking for the first time during this period. Undergraduate students did the University proud by winning various national and international competitions, including the national round of the Association for Computing Machinery International Collegiate Programming Contest (known as the ACM-ICPC competition), and represented South Africa at the ACM ICPC in China; the Standard Bank Challenge; the European Coding Catalyst Competition; the Entelect Challenge; and the Cybersecurity Challenge.

The Collaborative Laboratory, a joint initiative between the departments of Computer Science and Informatics and sponsored by industry, was established in 2013/2014. The purpose of the laboratory is to provide a conducive environment for teamwork for students completing the final year capstone project.

Changes to the undergraduate curriculum saw the introduction of three modules at second-year level to align the curriculum with the international ACM and Institute of Electrical and Electronics Engineers (IEEE) computer science curriculum. Three modules were introduced on theoretical computer science, databases and software modelling. The master's coursework programme in Big Data Science commenced in 2017. This programme was one of the first master's programmes in Data Science in the country.

In brief, the following on research entities in the Department of Computer Science:

- DST-NRF SARChI Chair in Artificial Intelligence was established in 2007 and renewed for two further five-year periods, in 2012 and again in 2017. The chairholder was Prof Andries Engelbrecht until 2018.
- The DRS Chair in Cybersecurity was a joint initiative between Dynamic Recovery Services (Pty) Ltd and the University. Introduced in 2017, the Chair was funded for a five-year period.
- The ABSA-UP Chair in Data Science started in July 2018 with the appointment of Dr Vukosi Marivate. Dr Marivate specialises in conducting research in Data Science (DS) with an emphasis on societal challenges. In particular, recent research has focused on the intersection of Machine Learning and Natural Language Processing (NLP).
- The MultiChoice Chair in Machine Learning is jointly located in the School of Information Technology and the School of Engineering, with Prof Nelishia Pillay, Head of the Department of Computer Science, and Prof Pieter (P) de Villiers, a lecturer in the Department of Electrical, Electronic and Computer Engineering and Head of the Department's Signal Processing and Telecommunications Research Group, as co-chairholders. The agreement entered into between UP and MultiChoice South Africa in 2018 was aimed at the pursuit of joint collaboration and research for common and mutual benefit. The Chair has subsequently undertaken academic and applied research, as well as human resource development in the field of machine learning, which is applied to several advanced topics of interest to MultiChoice.

## 2. Informatics

The number of academic staff in the Department of Informatics remained constant at 20 during this review period, although there were several resignations and vacant positions that were difficult to fill due to strong competition

from industry. After Prof Carina (C) de Villiers completed three four-year contracts as Head of Department, Prof Alta (A) van der Merwe was appointed on 1 October 2011 as the new Head of Department. When Prof Van der Merwe was appointed as Deputy Dean of the Faculty in August 2016, Prof De Villiers was re-appointed to this leadership position. She received the UP Teaching and Learning Award in 2016, a coveted award that was also received by Dr Riana (RA) Steyn in 2018. Dr Steyn also won the Chancellor's Award for Teaching and Learning in 2018.

Informatics is a multidisciplinary subject, where information, information systems, and the integration thereof into an organisation, are studied for the benefit of the entire system — individual, organisation and community.

Informatics studies the application and use of computer and information systems within an organisation. Our students' strength lies in their broad background in the economic and management sciences, which implies that the world of business is familiar to them. The use of information technology by organisations is growing exponentially and new, more complex and challenging applications are continually explored and being developed. This makes the teaching and research of Informatics both stimulating and challenging.

South Africa is an advanced user of information technology, and work opportunities for graduates have never been problematic. The world of work and environment that students are prepared for in Informatics is international and a substantial number of UP graduates are successful when they, in the process of expanding their professional skills, seek employment abroad. The Department also takes great care to ensure that the curriculum is in line with the curricula of overseas universities and lecturers participate in international conferences where educational approaches and curricula are presented and discussed. The degree is one of only two in Africa and the only one in South Africa that is internationally accredited by the Accreditation Board for Engineering and Technology (ABET).<sup>1</sup> The accreditation was granted from 2006 until 2013 after a visit from the accreditation committee in October 2007. After an accreditation visit in October 2013, accreditation was granted until 2020.

In the period under review, 43 students received a doctoral degree in Informatics, 438 master's degrees, 544 honours degrees and 684 students received a bachelor's degree.

In addition to students, international collaboration remained important. The Department hosted a large number of the top international scholars in Information Systems during

this period: Prof Michael (MD) Myers from the University of Auckland (New Zealand), Prof Ojelanki (OK) Ngwenyama from Ryerson University (Canada), Prof Richard (RL) Baskerville from Georgia State University (US), and Prof Knut (K) Hinkelman from the University of Applied Sciences and Arts (FHNW) (Switzerland) were regular visitors to the Department. Prof Baskerville and Prof Ben (BA) Schneidermann received honorary doctorates, respectively in 2014 and 2018.

The research focus areas of the Department were information systems and the organisation, information systems and education, ICT for sustainable development, human-computer interaction, and applied data science. Lecturers had a consistent yearly contribution to accredited journals and an excellent contribution to high-quality international conferences.

In 2018, the Department published 17,96 units. Lecturers have served on several international conference programme committees, routinely acted as reviewers for journals and conferences, and assisted with external examining for several universities in Africa. Nineteen of the twenty lecturers in the Department completed their doctoral degrees in 2018. Eleven of the twenty lecturers had an NRF rating by the end of 2018.

Early in this review period, in 2010, the Department hosted the European Conference of Information Systems at UP. This was the first time the conference was hosted in Africa, with more than 400 international researchers attending. In 2018, the Department celebrated 30 years since its inception with a gala event for students, former and current staff members, alumni and industry partners.

Finally, many successful short courses were presented by the Department through Enterprises UP. Among the courses presented were the certificates in Business Analysis and IT Project Management, the IT Management Programme, and various Computer Literacy programmes at the Mamelodi Campus.

## 3. Information Science

Prof Theo (TJD) Bothma held the position as Head of Department of Information Science until June 2016 when Prof Archie (AJ) Dick took over. Both acted as Chair of the School of Information Technology. By the end of 2018, the Department had twelve permanent academic staff, including three full professors, one associate professor and one senior lecturer, and one full-time and one part-time administrative staff. The NRF rating profile comprised a B2, two C1 and two Y ratings (Y1, Y2).

<sup>1</sup> See [www.abet.org](http://www.abet.org)

There was a large complement of temporary and part-time staff and towards the end of 2018, the Department shifted to focusing on the academic and professional development of the young and upcoming staff cohort. Junior staff published in international journals such as *Information Research*, *Aslib Proceedings*, and *Library Hi Tech* and participated in international conferences and panel discussions such as *Information Seeking in Context* (ISIC) and the *Society for the History of Authorship, Reading and Publishing* (SHARP) conferences. They completed their master's degrees and proceeded with doctoral studies.

With funding from ABSA and the Department, the Virtual Reality and Interaction (VRI) laboratory was officially established in 2018 and equipped with state-of-the-art technology. This offered enhanced training facilities for students and for the cohort of young academics in the multimedia degree programme the opportunity to stimulate both academic and industry-related research and establish academic and industry collaborative relationships. The focus was on collaboration with the Department of Mining Engineering and work relevant to the mining industry with support from the Minerals Education Trust Fund (METF), South Africa. Work was also done for other departments such as Civil Engineering and Construction Economics and companies like EPI-USE.

Senior staff published in international journals which included *African Identities*, *History of Education Quarterly*, *Journal of Scholarly Publishing*, *Lexicographica*, *Lexikos*, *Libri*, *Notes and Records of the Royal Society* and *Publishing Research Quarterly*. Local journals included the *South African Journal of African Languages* and *Tydskrif vir Geesteswetenskappe*. Staff presented at international scholarly conferences such as Information Seeking in Context (ISIC), iSchool, Association of Information Science and Technology (ASIS&T), World Library and Information Conference (International Federation of Library and Information Associations), and Euralex (Conference of the European Association for Lexicography).

Staff served on a variety of international editorial advisory boards and conference programme committees and held positions in professional associations and scholarly committees such as the ISIC Steering Committee's Chair Committee, the IFLA committee of Freedom of Access to Information and Freedom of Expression, and as Chair of the National Council of Library and Information Services in South Africa.

A highlight in the review period was Prof Dick's groundbreaking book, *The Hidden History of South Africa's Book and Reading Cultures* (2012). It was published by the University of



Toronto Press and the University of KwaZulu-Natal Press and placed on the long list for the Alan Paton Literary Award for non-fiction.

The Department strengthened its international profile through the appointment of international research associates and extraordinary professors, and pursued research collaboration in the United States, Australia, Denmark, the United Kingdom, Sweden and Finland. It hosted visiting professors and signed a memorandum of understanding with the Department of Information Science, University at Buffalo SUNY (US). Collaborative initiatives included the Social Epistemology and Information Science conference in Denmark, and a German-based DAAD research project. Funding came from The British Academy, Royal Danish Academy of Sciences, Publishers Association and Newton Mobility Award. Contract research was done for the Publishers' Association of South Africa (PASA), the South African Bookseller Association (SABA) and the International Federation of Library Associations and Institutions (IFLA).

No major changes were made to the three degree programmes — in Information Science, Multimedia and Publishing — offered on bachelor's, honours, master's and doctoral levels. The Department introduced a coursework master's degree specialising in Library and Information Science for African librarians at tertiary institutions working in an IT environment, and also in Library and Information Science with funding from the Carnegie Corporation of New York. The initial US\$ 2 million grant for the period 2011–2015 was received in 2010, with an extension of US\$1m for the period 2015 to 2017. The programme involved collaboration with academic staff from the University of Makerere (Uganda) and the University of Wisconsin, Milwaukee (US). A blended teaching approach was followed using online teaching and site visits to Uganda, the US and Pretoria. A Carnegie Corporation of New York grant was also received for a Continuing Professional Development programme.

The Department also offered courses through Continuing Education at University of Pretoria Trust (CE at UP), now known as Enterprises, on information and knowledge management, competitive intelligence and internet searching.

### African Centre of Excellence in Information Ethics

The African Centre of Excellence in Information Ethics (ACEIE) was established in 2012 with funding from the Department of Communications, for collaborative local and international research and training in Information Ethics. Funding was also received from the Department of Telecommunications and Postal Services.

## GRADUATE SCHOOL OF TECHNOLOGY MANAGEMENT

### 1. Engineering and Technology Management

The Graduate School of Technology Management (GSTM) was established in 2007 as the fourth School in the Faculty. The GSTM comprised a single department, the Department of Engineering and Technology Management, which offers an honours, three master's and doctoral degrees. Student numbers increased significantly from 2009 to 2018, and more than 2 900 degrees were awarded, including 21 doctoral degrees.

The GSTM is aligned to enhance UP as a research-intensive university and collaborates on interdisciplinary research within the Faculty and with various local and international institutes and industries. The School has addressed challenges related to the fourth industrial revolution and new business model innovations in its curricula and research. It played a vital role in setting up TuksNovation, a technology incubator, originally for EBIT, which quickly expanded to include technology start-ups for all UP students and staff.

The Department of Engineering and Technology Management celebrated its 30th anniversary in 2017. Engineering management as a discipline was introduced at the University of Pretoria with the establishment of an industry-sponsored Chair for Engineering Management in 1987. Prof Gideon (G) De Wet was the first chairholder. A separate department, the Department of Engineering and Technology Management, was established in the former Faculty of Engineering in 1994 and it was the first and only one of its kind in South Africa. Prof Antonie (AM) de Klerk became its first Head of Department and held this position until 2000. He was succeeded by Prof Tinus (MW) Pretorius, who was also the Chair of the GSTM till his retirement in 2016. Prof Elma (E) van der Lingen was appointed as Chair of the School and Head of Department in October 2016.



UP Mining Industry Study Centre

The Department prepares postgraduate students and industry leaders with management skills and enhanced technology ability to the benefit of the national and international community. It offers internationally recognised postgraduate programmes at honours, master's and doctoral levels which address different needs in the field of engineering management, technology and innovation management, as well as project management.

Over three hundred new students are admitted to the various programmes per year and the total number of registered students averages approximately 700 students per year. Students from previously disadvantaged groups increased to more than 80% in 2018, and further, consisting of 37% female and over 20% international students.

The Department collaborated on research and teaching initiatives with institutions from 14 countries and was part of several internationally funded programmes.

Notable partnerships included:

- With seven other international institutes, the Department was a partner in the European Union Horizon 2020 MSCA RISE collaborative research project, which focused on developing frameworks for modelling total value and total cost of ownership of engineered assets deployed in both public and private sector businesses.
- Between 2013 and 2016, the Department participated in a five-year research project titled, Enabling Productivity and Innovation in Low-Income Countries (EIP-LIC),

funded by the British Department for International Development (DFID) and coordinated by Tilburg University in collaboration with Radboud University in the Netherlands. The project aimed to conduct research to fill knowledge and information gaps on innovation in LICs from economic and policy perspectives. The Department led the study on innovation in manufacturing small and medium enterprises (SMEs) in South Africa, resulting in a comprehensive country report on Innovation by Manufacturing SMEs in South Africa.

- In the project management discipline, the Department participated in the Project Management Institute's Global Leadership Project from 2017 to 2019; the project won the Project Management Institute (PMI) Research Award in 2019.
- It played a leadership role in the development of ISO 21505 — Governance of Projects, Programmes and Portfolios. The standard was completed in 2017 and adopted as a SANS 21505 standard in 2020.
- The 2018 International Project Management Association (IPMA) Global Research Award as Young Researcher was bestowed on Dr Taryn (T) Bond-Barnard, a senior lecturer in the Department.

In 2011, the University of Pretoria introduced selected research focus areas referred to as Institutional Research Themes (IRTs). The Department coordinated the *energy* IRT embracing transdisciplinary research cutting across many faculties and departments. As a direct result of the Department's work in energy systems, several collaborative activities have been forged, notably with the University of Stuttgart's Institute for Energy Economics and the Rational Use of Energy (IER) in Germany, and the Slovak University of Technology in the Slovak Republic.

A memorandum of cooperation between the GSTM and Shandong University (China) resulted in annual guest lecturing in China since 2013 and hosting Chinese PhD candidates in the Department. The Department and two Norwegian universities collaborated on entrepreneurship education and research in the research project funded by the Southern African—Nordic Centre (SANORD) titled, "Translating good

practices in entrepreneurship education across borders and context", resulting in various publications and continued collaboration.

The Construction Industry Institute (CII)-Africa Chapter was established in 2014 and is hosted by the Department. This CII-Africa is fully affiliated with CII hosted at the University of Texas, Austin (US).

With respect to programme and qualification changes, the Department broadened its focus to include innovation management in addition to the School's focus on engineering, project management and technology management, and resulting in a master's degree in Technology and Innovation Management (MTIM). All three masters' programmes were aligned to consist of seven core modules, two elective modules and a research component in the form of a mini-dissertation. As UP is a research-intensive university, the research component at master's level was increased from 30 to 50%. Programme and curricula changes were implemented in all postgraduate programmes to keep abreast with current developments and to meet the requirements of industry and government. The honours degree in Technology Management was changed to the honours in Engineering and Technology Management (ETM) and the ETM's programme curriculum was amended from eight to six modules and also includes a research report.

The Department's Master's degree in Project Management (MPM) received accreditation from the Global Accreditation Centre of the US Project Management Institute (PMI). The Department is the only institute in Africa with this accreditation for a masters' programme in project management. The MPM also holds accreditation from the South African Council for the Project and Construction Management Professions (SACPCMP).

In addition to the degree programmes mentioned above, the Department also offers, in collaboration with Enterprises at UP, specialised continuing education in the form of year programmes, short courses and online courses in the Department's research fields. The Programme in Project Management (PPM) celebrated its 20th anniversary in 2017.



Credit: Lucinda du Toit



## 4 | Health Sciences

### DEAN'S OVERVIEW

From 2009 to 2018, the Faculty of Health Sciences retained a relatively stable structure, comprising four schools — Dentistry (SoD), Health Care Sciences (SHCS), Health Systems and Public Health (SHSPH), and Medicine (SoM) — and 43 departments. Of note during this period was the development and roll-out of University of Pretoria's long-term strategic plan, UP 2025, the Academic Plan and one- and five-year implementation plans, the latter respectively for the periods 2012 to 2016 and 2017 to 2021.

It follows that many of the developments within the Faculty of Health Sciences were aligned with UP's vision of being "a leading research-intensive university in Africa, recognised internationally for its quality, relevance and impact, and also for developing people, creating knowledge and making a difference locally and globally".<sup>1</sup>

Within the Faculty of Health Sciences, strategic developments included the appointment of three deputy deans, respectively for research, teaching and learning, and stakeholder relations; the establishment of new research centres and institutes that harnessed the collaborative power of expertise within the Faculty and the University; and infrastructural development on the Prinshof South and Prinshof North campuses.

As with the rest of the University, the #FeesMustFall protests that occurred in 2015/2016 created a major disruption for the UP 2025 plan, with many administrative decrees being put in place to deal with political and financial instability. Almost instantaneously posts were frozen and no new posts were being created, which limited the growth of the various research centres and institutes. After 2016, many changes reflected cost saving measures, the need to enable teaching and learning on a hybrid platform, and transforming and decolonising the curriculum.

The senior faculty management team, from 2008 to 2011, comprised a Dean and a Deputy Dean. This format required a clear division of roles, with the Dean concentrating on the external interfaces of the Faculty with relevant national and provincial departments of health, as well as national and international stakeholders. The Deputy Dean largely served as the ex officio operational manager of the Faculty, including student matters and student administration. From 2012 to 2014, the Dean was joined by the Deputy Dean: Research and Postgraduate Studies and the Deputy Dean: Teaching and Learning. In 2017, a further portfolio was added to the Deanery, namely that of Deputy Dean: Health Stakeholder

l to r: Prof Tiaan de Jager, Prof Cheryl de la Rey and Prof Eric Buch



Relations. Thus, by the end of the review period, the Deanery comprised the Dean and three Deputy Deans:

- The Deputy Dean: Research and Postgraduate Studies would be responsible for advancing research in the Faculty, by creating a Research Support Office which would facilitate financial management, easing applications for funding, as well as providing biostatistical and editing support.
- The Deputy Dean: Teaching and Learning would be responsible for all student matters in the Faculty, advancing educational innovations and overseeing transformation in the Faculty.

<sup>1</sup> University of Pretoria. 2011. Strategic Plan: The vision, mission and plan of the University for 2025. (See Appendix A.)

Prof Tiaan de Jager | Dean, 2016–2018 and beyond



- The Deputy Dean: Health Stakeholder Relations would be solely responsible for facilitating complex interactions between the Faculty and the provincial and national departments of health, as well as national and international stakeholders.

From 2009 to 2018, the Faculty had four different Deans. Prof Thanyani (TJ) Mariba completed his second term as Dean on 31 September 2009, Prof James (JA) Ker took his place as Acting Dean, a role which he fulfilled until 2011, when Prof Eric (E) Buch was appointed as the new Dean. Prof Buch was Dean of Health Sciences until mid-2016. He was succeeded by Prof Tiaan (C) de Jager, first as Acting Dean from July 2016 to March 2017 and then as Dean.

The leadership positions as Deputy Deans were fulfilled as follows:

- Prof Ker completed three years as Deputy Dean (2009–2011).
- The newly created Deputy Dean: Research and Postgraduate Studies was first held by Prof De Jager from 2016 until his appointment as Acting Dean. The post remained vacant until beyond 2018.
- Prof Dianne (D) Manning filled the position of Deputy Dean: Teaching and Learning from 2012 up to her retirement in 2019.

- Prof Arthur (JLA) Rantloane was the first to assume the role of Deputy Dean: Health Stakeholder Relations in 2017 and held the position beyond 2018.

Supporting the Deanery, Karen (KK) du Preez assumed the responsibility of Faculty Manager from 2007 and still held the position in 2018 and beyond. Rob (R) Cooper was the Head of Student Administration (2009 and beyond). The Skills Laboratory, which was established in 1997 under the leadership of Prof Ina (I) Treadwell, was maintained during the review period under the leadership of Prof Rhena (R) Delpoit, from 2008 to 2018 and beyond.

### Research entities

The period spanning 2009 to 2018 saw great strides towards achieving UP's research goals, with the Faculty of Health Sciences establishing several research institutes and entities. Most of these entities were born from the research frontiers identified as existing initiatives and potential high impact fields within the Faculty. These early research frontiers included:

- Cellular and Molecular Medicine
- Conservation Medicine
- Sports Medicine and Diseases of Lifestyle
- Imaging
- Maternal and Infant Health
- Forensic Science
- Endocrine Cancers
- Malaria.

By 2018, most of these research frontiers had been formalised into distinct research entities, creating platforms that invited collaboration with international and national partners.

### Sport, Exercise Medicine and Lifestyle Institute

In 2008, the Sports Medicine Division was housed within the School of Medicine and headed up by Christa (DC) Janse van Rensburg. Already, the Division was known as a Centre for Sport Sciences. With the formalisation of the University's long-term strategy, sport, exercise medicine and lifestyle interventions for chronic disease were identified as one of four main strategic niche research areas and much investment was made to realise this strategic goal.

This included the establishment of the Sport, Exercise Medicine and Lifestyle Institute (SEMLI) in June 2015, under the directorship of Prof Martin (MP) Schwellnus, who has remained in this leadership position. Growing from a modest four staff members in 2008, all housed within the School of Medicine, SEMLI now brings together more than 70 staff members from various health sciences departments and other UP faculties. SEMLI is housed in the High Performance Centre (hpc) on the Hillcrest Campus.

### UP Institute for Sustainable Malaria Control

Originally the UP Centre for Sustainable Malaria Control, started in May 2011, the UP Institute for Sustainable Malaria Control (UP ISMC) attained its status as an institute in June 2016. Prof Tiaan de Jager was the Director of the UP ISMC from inception to beyond 2018. The UP ISMC is a collaborative space, integrating human health, vector control and parasite control, aimed at identifying interventions that will end malaria in South Africa.

The UP ISMC hosted the SARChI Research Chair in Sustainable Malaria Control from 2013 to 2017, which was extended for a further five-year cycle in 2018 as a Tier 1 Research Chair. The incumbent, Prof Lyn-Marie (L) Birkholtz, has also led the DST-NRF Community of Practice in Malaria Elimination, awarded in 2017.

The UP ISMC is a South African Medical Research Council (SAMRC) Collaborating Centre for Malaria Research.

### Institute for Cellular and Molecular Medicine

Since its inception in 2008, the Institute for Cellular and Molecular Medicine (ICMM) has grown consistently and, by 2018, had 10 research groups from three UP faculties. Prof Michael (M) Pepper remained the Director from inception to beyond 2018.

The ICMM has a broad research focus and the disciplines concerned include genetics/genomics, cell-based therapy, the neurosciences, bio-entrepreneurship and the regulatory (legislative) environment. The primary aim of the ICMM is to alleviate the ever-growing burden of communicable and non-communicable diseases in South Africa by developing therapies for the genetically diverse South African population.

The ICMM also hosts the SAMRC Extramural Stem Cell Unit, first established in 2015 for a five-year period and subsequently extended to 2025.

### SAMRC-UP Maternal and Infant Healthcare Strategies Research Unit

Maternal, foetal, newborn and child health is a priority research area in the Faculty of Health Sciences, as well as for the SAMRC and the national Department of Health (DoH). Established as an extra-mural research centre in 1997 under the directorship of Prof Bob (R) Pattinson, the SAMRC-UP Maternal and Infant Healthcare Strategies Research Unit was awarded research centre status in 2017 and is under the leadership of Prof Ute (U) Feucht, who has filled this role since 2016.

The Centre's research focus is on developing and implementing effective interventions in maternal, newborn and child health care at primary and secondary levels of care. The Centre also contributes to national audit reports and collaborates with various international universities and agencies.

### Forensic Anthropology Research Centre

Established in 2008, under the directorship of Prof Maryna (M) Steyn, the Forensic Anthropology Research Centre (FARC) became a centre of excellence in forensic anthropology education, research and community service in South Africa. In 2015, Prof Erica (E) L'Abbe succeeded Prof Steyn as Director and remained in this position until beyond 2018. Research in FARC focuses on human variation in modern populations, particularly South Africans, for applications in orthodontics and medico-legal investigations, namely facial approximations, presumptive identifications, patterns of decomposition and interpretations of traumatic injury to bone. FARC researchers also study the evolutionary history of South African fossil hominins and have taught Physical and Forensic Anthropology.

### Environmental Chemical Pollution and Health Research Unit

Established in 2012, with Dr Natalie (NH) Aneck-Hahn as Director, the Environmental Chemical Pollution and Health (ECPH) Research Unit is a collaborative partnership between the Faculty's School of Health Systems and Public Health (SHSPH) and Andrology in the Department of Urology. Dr Aneck-Hahn has remained the Director beyond 2018.

The Unit uses the Endocrine Disrupting Chemical (EDC) and Toxicology laboratories for its research. The Andrology laboratory functions as a clinical and research laboratory that investigates male reproductive health. The EDC component

offers a comprehensive battery of bioassays for estrogenic and androgenic activity in environmental samples and specific chemicals. The toxicology section is primarily a research laboratory to assess reproductive health in humans and wildlife.

The Unit conducts research on the occurrence, health effects and projected future impacts of chemicals, especially EDCs, on environmental pollution and health.

### Centre for Viral Zoonoses

The Centre for Viral Zoonoses (UP-CVZ) was officially established in June 2016 and is located in the Faculty's Department of Medical Virology with members and collaborators in three different faculties — Health Sciences, Natural and Agricultural Sciences and Veterinary Science. The first and current Director (2016 to 2018, and beyond) was Prof Wanda (W) Markotter.

The UP-CVZ investigates endemic and emerging zoonotic viral diseases of public health significance in humans, animals and the environment. The Centre has joined forces with established research groups in arbovirology, bat and other small mammal viral zoonotic diseases, rabies and rabies related lyssaviruses, viral pathology, medical entomology and ecology. It strives to generate new knowledge through surveillance, building diagnostic capacity through innovation, epidemiology, pathology, pathogenesis and ecology of zoonotic pathogens in humans and animals, and to identify intervention strategies for effective disease control following a One Health approach.

Prof Markotter also holds the SARChI Chair in Animal Infectious Diseases (Zoonoses), awarded to UP in January 2016.

### UP Community Oriented Primary Care Research Unit

The Department of Family Medicine in the School of Medicine established the UP Community Oriented Primary Care (UP COPC) Research Unit as part of the COPC project. The Unit has undertaken a range of research projects on substance abuse, community health and community health education. All the research projects form part of the development and implementation of COPC through the Ward-based Outreach Teams (WBOTs).

Since its establishment in October 2015, the Centre has been under the directorship of Prof Jannie (JF) Hugo.

### Centre for Neuroendocrinology

The Centre for Neuroendocrinology (CNE): Brain/Body Dialogues, a research centre established in 2015, is directed by Prof Robert (RP) Millar. Principal Investigators, Dr Claire (CL) Newton (Deputy Director) and Dr Ross (RC) Anderson, were joined by Dr Iman (I) van den Bout in 2017.

The Centre's research addresses how the brain detects the external environment and internal environment (body), and how these cues are integrated in the hypothalamic area to produce hormones which regulate all aspects of body health, including stress, metabolism, appetite, growth and reproduction. Disturbance of this homeostasis results in debilitating diseases such as obesity and diabetes, a failure to grow, infertility and cancers of the prostate, breast and female reproductive tract.

### Centre for Ethics and Philosophy of Health Sciences

In 2015, Director Prof Werdi (W) van Staden established the Centre for Ethics and Philosophy of Health Sciences to develop academic capacity and produce scholarly output that builds on international developments in the field of ethics. Further, the Centre responded to professional regulatory requirements, niche opportunities and the needs for ethics and conceptual sophistication that are pertinent to professional practice and theoretical engagements of all health sciences. To these ends, the Centre provided a synergistic research platform for its associates and students.

Originally known as the Nelson Mandela Chair in Philosophy and Ethics of Mental Health, the Centre was housed within the Department of Psychiatry from 2011 to 2014.

### Rand Water Chair in Public Health and Water

Prof Maureen (MB) Taylor held the Rand Water Chair in Public Health and Water from 2013 to 2018. This award from Rand Water was valued at about R1 million per year for five years.

### Infrastructure development

During the review period 2009 to 2018, the Faculty of Health Sciences made great efforts to improve infrastructure to meet the high standards of the other UP campuses.

In 2012, the Department of Higher Education and Training (DHET) approved a discretionary allocation of R311 million for University of Pretoria from the National Skills Fund (NSF) with the specific objective of increasing the number of first-year

MBChB students from 240 to 350 initially, and to grow to 400 students per year over time. This approval made possible the following infrastructural developments:

- A new 400-seat lecture hall on level 4 of the HW Snyman Building.
- A new Dean's administrative complex on level 5 of the HW Snyman North Building.
- The redevelopment of the level 4 area east of the HW Snyman Building as a gateway to the new lecture hall, which includes a cafeteria, bookstore and informal learning area.
- Extensions to the Library and a skills laboratory.
- Construction of a 300-bed student residence with associated parking.

The project resulted in increasing the capacity of the School of Medicine at UP by two thirds, thereby helping to address the national shortage of doctors. Through this project, opportunities were created annually for an additional 160 students who would otherwise have been turned away due to capacity constraints.

The new 300-bed student residence, named TUKS Bophelong, was officially opened in February 2016 by Minister of Higher Education and Training, Dr Blade Nzimande. The Academic complex, named the Tswelopele Building, was constructed over three years and has been used for student purposes since January 2016. This building houses four lecture halls, all with a 400-seat capacity, and special facilities, including a rehabilitation gymnasium and facilities for the ethics committee.

### Performance, in overview

Table 4.2 provides a summary of student enrolment and graduation. In addition, the [infographic on pages 188 to 189](#), illustrates the collective achievement of the Faculty of Health Sciences over this period.

In overview:

- Across all four Schools, undergraduate student enrolment increased from 3 475 in 2009 to 5 541 in 2018, of which 46,4% were black in 2009 and 61,9% in 2018.
- The module pass percentage stayed high throughout this period — from 93,6% in 2009 to 94,3% in 2018.
- The number of graduates increased from 754 in 2009 to 1 533 in 2018, while the percentage black graduates increased from 36,3% to 52,5% over the same period.
- The total postgraduate enrolment increased from 1 263 in 2009 to 1 409 in 2018, of which the percentage of black postgraduate students increased from 56,4% in 2009 to 67,6% in 2018.
- Weighted M and D research output increased from 0,17 in 2009 to 0,54 in 2018, and the overall research output units from 156,9 to 231,3 over this same period.
- By 2018 there were 47 NRF-rated researchers in the Faculty of Health Sciences, with 52% of academic staff holding PhDs.

**Prof Tiaan de Jager** | Dean, 2017-2018 and beyond

Table 4.2. Health Sciences student enrolment and throughput, 2009 to 2018

Indicators	2009	2010	2011	2012	2013	2014	2015	2016	2017	2018
# headcount UG enrolments	3475	3755	4010	4320	4794	4782	4863	5201	5462	5541
% black UG students enrolled	46,4%	49,0%	50,6%	52,9%	56,8%	56,6%	56,2%	58,8%	60,1%	61,9%
# UG graduates	754	864	933	1025	1172	1167	1213	1364	1440	1533
% black UG graduates	36,3%	40,9%	45,3%	47,3%	48,4%	48,3%	47,6%	53,4%	50,5%	52,5%
# PG enrolment	1263	1331	1350	1355	1310	1390	1327	1405	1396	1409
% black PG students enrolled	56,4%	60,9%	60,5%	63,0%	62,3%	64,0%	62,5%	65,6%	67,5%	67,6%
# M and D graduates	158	144	203	163	187	173	191	217	232	271
% M and D black graduates	54,4%	58,3%	53,7%	58,9%	58,3%	54,9%	58,1%	52,5%	61,2%	66,1%

# HEALTH SCIENCES: PERFORMANCE AT A GLANCE

## Enrolment and success

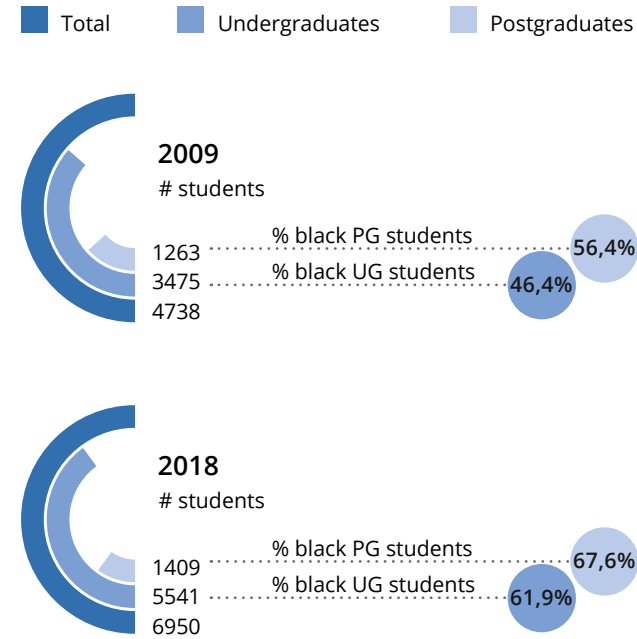

### Undergraduate module pass %

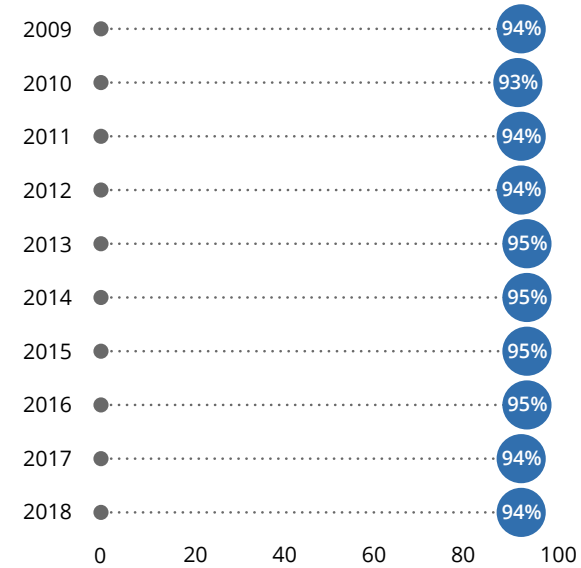

## UG graduates

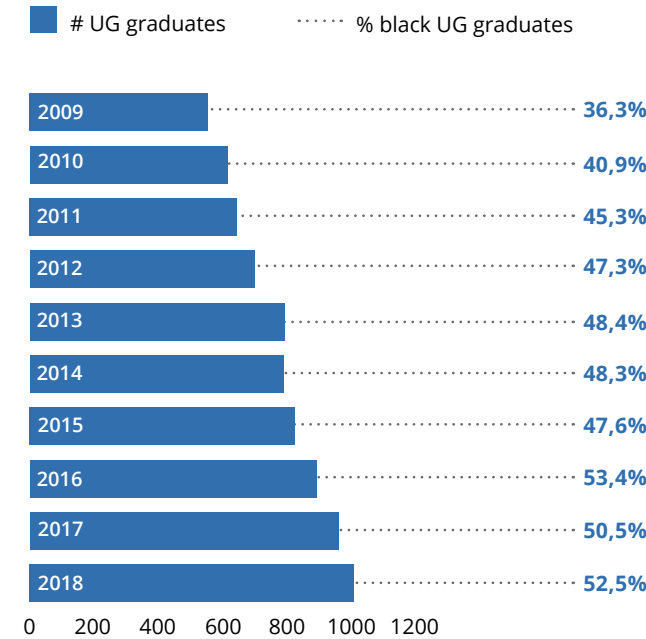

### Student : staff ratio

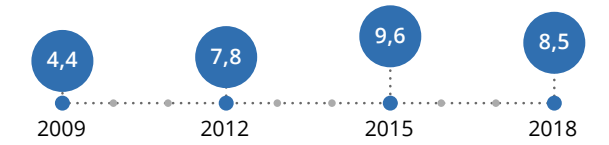

### Weighted M and D output

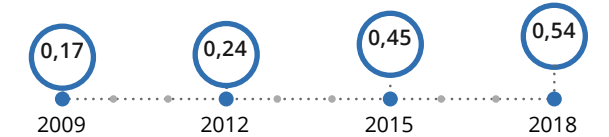

## Research pipeline

### M and D enrolment

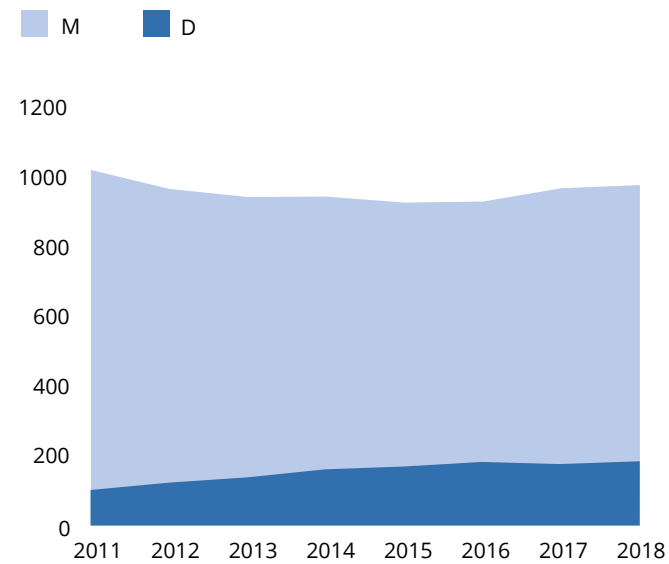

### M and D graduates

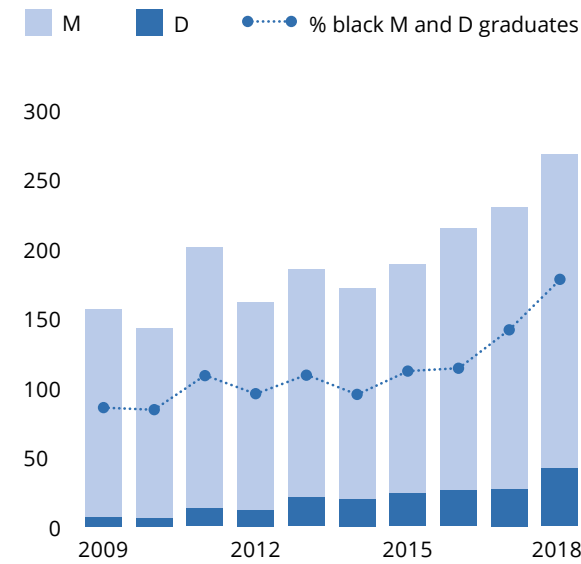

## Capacity and productivity

### % Academic staff with PhDs

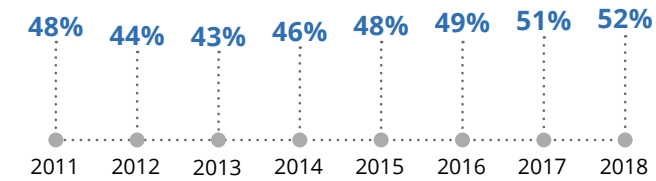

### NRF-rated researchers, 2018



### Research output

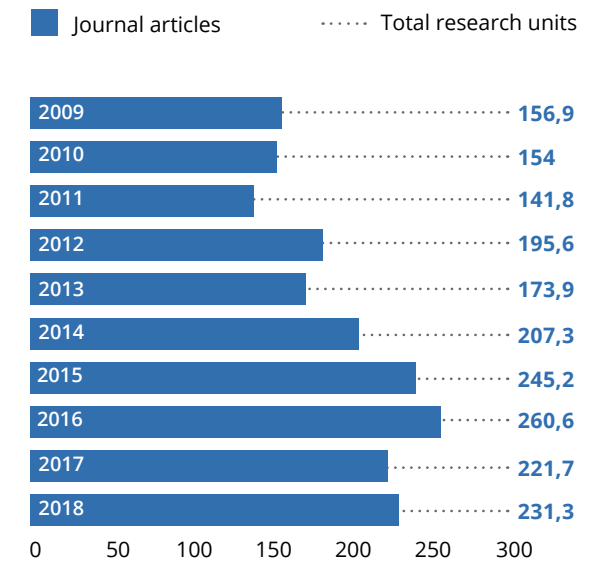

## SCHOOL OF DENTISTRY

The School of Dentistry at the University of Pretoria is widely recognised nationally and internationally for the quality of its training, research, patient care and its involvement in community-based projects. Oral health care graduates contribute to the practice of dentistry and oral hygiene, and to health management, statutory councils and academic training.

The Faculty of Dentistry, established in 1950, merged with the Faculty of Medicine in 2001 to form the Faculty of Health Sciences. The Faculty of Dentistry became the School of Dentistry, home to eight departments. Prof At (AJ) Ligthelm was the Dean of the Faculty of Dentistry (1996–2001), and then the chairperson of the School of Dentistry from 2001 to 30 April 2016. Prof Ligthelm's appointment was extended for a further two years until 30 April 2018. Prof George (JG) White assumed the role of acting chairperson from 1 May 2018 to 30 November 2019.

During the review period, the School of Dentistry experienced a tremendous need to expand training facilities, given technological advances in the field. The improvements were made possible by a partnership between the University and the Department of Higher Education and Training (DHET). The extension of the Oral and Dental Hospital meant improved patient flow, high-quality dental surgeries and equipment, excellent waiting room facilities for patients, as well as optimal provision of facilities for persons with disabilities. The ground floor (second level) of the hospital was expanded by 1 400m<sup>2</sup>, comprising 11 dental consulting rooms, an administrative section, waiting areas for patients and a number of offices. The third level includes a lecture hall, conference and seminar rooms, a number of offices, a multimedia facility and a postgraduate clinical unit. The new wing of the hospital was officially opened on 17 February 2011 by the Vice-Chancellor and Principal, Prof Cheryl de la Rey.

All undergraduate students in the School of Dentistry participated in community service projects during this period, which included aspects of preventive and interceptive oral health services at schools in and around Pretoria, and engagement linked to the Phelophepa Health Train project (established in 1993). The School's active participation in the Phelophepa Health Train project made it possible for students to visit remote rural areas where there are very little or no oral health care facilities. In addition, the community service rendered by students, particularly in Hammanskraal, was an excellent source of material for community-based research.

### Undergraduate programmes

The School of Dentistry offered two basic undergraduate degrees:

- Bachelor of Dentistry (BChD), a five-year programme; and
- Bachelor of Oral Hygiene (BOH), a three-year programme.

Only 70 and 25 first-year students were selected every year for the BChD and BOH degrees, respectively.

Prof Willem (WD) Snyman was the Programme Manager: Education for the period 2009 to 2018, with responsibility for managing all the undergraduate programmes in the School.

### Joint appointments and hospital management

The School of Dentistry is located in the Oral and Dentistry Hospital building, also known as the UP Oral Health Centre, on the Prinshof South Campus. The Oral and Dental Hospital building is owned by the University of Pretoria, with large parts of the hospital being rented by the Gauteng Department of Health. All academic staff in the School of Dentistry are joint appointments shared between UP and Gauteng Department Health and staff are therefore required to contribute to the clinical load within the hospital.

Prof George (JG) White held the position of Programme Manager: Hospital Management (hospital manager) from 1993 to beyond 2018. His responsibilities have included maintaining and providing high levels of support to ensure quality service to patients and other clients.

In the School of Dentistry, the Programme Manager: Research position was held by Prof Flip (PJ) van Wyk from 2004 to 2017. Prof Leanne (LM) Sykes assumed the position in 2017 until beyond 2018. As the Programme Manager: Research, Prof Sykes also represented the School of Dentistry in the Faculty Research Committee. The Faculty Research Committee was split into two entities, with Prof Sykes appointed as the Chair of the Postgraduate Committee. This Committee handles all matters concerning postgraduate students, including the submission and review of all research protocols.

Research in the School remained closely tied to the School's postgraduate offering, with all postgraduate students completing research projects as part of their degrees. Research in the School included several foci, namely oral epidemiology, health systems and health services, quality of life and tobacco control, maxillo-facial and oral surgery, dental practice management strategies and development,



implementation and evaluation of a teaching curriculum in dentistry, clinical and laboratory research on dental materials, oral carcinoma, HIV/AIDS, forensic dentistry and comparative oral pathology, orthodontics, tissue engineering research in the field of periodontics, and prosthodontics.

Between 2012 and 2018, researchers in the School of Dentistry published 275 research articles, steadily increasing the research output from 31 publications in 2012 to 48 in 2018.

## DEPARTMENTS

### 1. Community Dentistry

Prof Flip (PJ) van Wyk was the Head of the Department of Community Dentistry from 2000 to 2014. When Prof van Wyk retired in December 2014, he was succeeded by Prof Ahmed (A) Bhayat who filled the headship position from 2015 to 2018.

The Department is actively involved in training dental and oral hygiene students, both at the undergraduate and postgraduate levels. One of the core pillars in community dentistry is community engagement and outreach projects. These outreach programmes take students out of the dental school and expose them to communities. Students visit schools, special schools, crèches and clinics to provide oral hygiene education, nutritional information and dental services via mobile dental clinics. These visits allow students to engage with the communities and identify their needs through practical and relevant research projects, offer disadvantaged communities oral health services, something many of them cannot afford, and improve students' clinical skills.

Several community outreach projects have been initiated with sponsors such as Colgate Palmolive and GlaxoSmithKline. These projects focus on preventing common oral diseases and promoting oral health education, especially in less affluent communities. The services offered as part of these projects are delivered by means of mobile dental units (MDUs), the Transnet Phelophepa Health Care Train and various school

outreach programmes. Most of these services are rendered by senior dental and oral hygiene students who work under the supervision of staff members in the Department.

One of the MDUs, which is used to provide dental services at schools, has been stationed at the Generaal Nicolaas Smit School in Pretoria West. Pretoria West is one of the poorer suburbs in the region and many of the learners at the school come from disadvantaged homes. Dental and oral hygiene students offer services at the MDU three times per week, during which learners are screened and, if necessary, treated. Common procedures include extractions, restorations and the placement of fissure sealants. A second MDU is stationed at the Daspoort Primary Health Care facility. Staff members and students visit the clinic weekly and offer primary dental services such as oral hygiene education, restorations, extractions and cleaning (scaling and polishing) to community members.

As a result of a Memorandum of Understanding signed between Transnet and all dental universities in 2008, an exciting project was launched that uses a train to offer dental services to rural and isolated communities. The agreement allows UP dental and oral hygiene students to make use of a train service to visit these communities during an eight-week rotation on an annual basis. The rotation schedule means that each group, which consists of six dental and two oral hygiene students, spends two weeks providing basic oral health care services, including dental screenings, extractions, restorations, scaling and polishing, placement of fissure sealants, as well as oral hygiene education. On average, students treat between 20 and 30 patients per day and in total around 800 patients are treated by UP students during the eight-week period. Students also have the opportunity to visit nearby schools and offer oral hygiene education and nutritional advice.

In terms of the Department's school outreach projects, staff and students regularly visit nursery schools all over the city in order to determine a baseline oral health status of young children, to improve oral health knowledge and to establish preventive procedures at a young age. The idea behind these visits is to prevent young children from suffering from dental caries and to allow for the planning of future dental services.

The oral hygiene staff and students of the Department also adopted four special needs schools in and around Pretoria, namely the Alma School for mentally disabled children, Prinshof School for visually impaired children, Trans-Oranje School for hearing impaired children and Pretoria School for children with cerebral palsy. These schools are visited on a weekly basis and brushing programmes have been

implemented and are being monitored by both students and teachers. As part of the programme, each child receives a toothbrush that is marked with their name in order to allow them to continue the brushing programme on a daily basis. The aim is to empower these children to be able to brush their own teeth well. Oral hygiene students teach and then supervise the children's brushing technique.

A few of these projects included:

- Primary Oral Health Care Project (POHC) for Primary Schools in Pretoria, coordinated by Dr Thommy (TK) Madiba; and for the Daspoort Clinic, coordinated by Nthabiseng (NJ) Sofala
- Educational and preventive service to HIV/AIDS patients, coordinated by Dr Tshepiso (T) Mfolo
- Educational and preventive service to pre-primary schools; and clinical preventive service, coordinated by Renee (RC) du Bruyn
- Preventive service at the Steve Biko Hospital, coordinated by Nthabiseng Sofala
- Preventive Clinics for Special Patients, coordinated by Dr Candice (C) van Wyk
- Educational and preventive services to mentally and physically disabled children, coordinated by Candida (CCP) Kruger.

The training of Oral Hygiene students fell under the Department of Community Dentistry. As from 2011, the Diploma in Oral Hygiene was modified to a Bachelor of Oral Hygiene, stretching over three years. Oral Hygiene students were extensively trained in the prevention and management of oral diseases. In line with the undergraduate curricula in this Faculty, the curriculum was outcomes-based, problem-based, student-oriented and community-directed, with the vertical and horizontal integration of modules.

Research foci in the Department include oral epidemiology, oral health services research, oral disease and quality of life, preventive dentistry, tobacco control research and capacity building, clinical epidemiology and phytomedicine.

## 2. Dental Management Sciences

Prof George (JG) White was Head of Department of the Department of Dental Management Sciences for the entire review period 2009 to 2018. During this time, Prof White also filled the position of Hospital Manager of the Oral and Dental

Hospital and served as acting chairperson of the School of Dentistry from May 2018 to 30 November 2019.

The Department, established in 2006, was the first of its kind at a dental teaching institution in South Africa.

Aside from offering undergraduate modules in the BChD and BOH degrees, the Department also offered a Postgraduate Diploma in Dental Practice Management, and a master's in Practice Management, MScDent (Practice Management).

The master's programme is designed to build graduates' knowledge and skills (other than clinical skills) and equip them with the necessary competencies in dental practice management to improve the business management of an existing oral health practice (private/public) or to successfully establish a new oral health practice. The programme also enhances their existing knowledge of ethics and jurisprudence, leadership, strategic management, marketing, financial management, information systems, personnel management, occupational health and safety, patient management, administrative management and risk management applicable to the oral health practice environment. Finally, it creates an opportunity for dentists to become effective leaders and managers, in a demanding South African context.

During the review period, research conducted in the Department aimed at relevance and needs specific to South Africa in terms of management, leadership, communication, ethics and patient care. As a result, research output focused on the following, among others:

- Dental student perceptions of practice management, as well as their career expectations.
- Dentists' perceptions about strategic management of a dental practice: a survey about the perceived influence of the external environment on the strategic management of a dental practice.
- Leadership: the challenges faced by dental practitioners and the difference between management and leadership.
- Practice management strategies in a competitive dental environment in order to enhance the viability of a typical South African dental practice through excellence, uniqueness, differentiation and competitiveness.
- Managed dental care: implications for the dental practitioner in South Africa.
- The important role of the oral hygienist in the productivity of a South African dental practice.

- Ethics and jurisprudence: investigation regarding complaints laid against oral health care professionals and employment of risk management strategies to manage and prevent complaints.
- Health services research: researching the demand for public health services, service delivery outcomes as well as the determinants of the public's perceptions about the ethical and professional behaviour of public and private oral health care practitioners.
- Dental education: research about curriculum development, development of clinical reasoning, management of cognitive load, integration, the link between the basic medical sciences and the clinical sciences, and student support.

## 3. Maxillo-facial and Oral Surgery

Over the review period, the Department of Maxillo-facial and Oral Surgery saw three Heads of Department, namely Prof Kurt (KW) Bütow (2008–2012), Prof Frederik (FJ) Jacobs (2013–2016) and Dr Sharan (S) Naidoo who was the Acting Head for the period 2017 to 2018.

The Department consisted of seven divisions:

- Exodontia (removal of teeth and root rests)
- Dento-Alveolar Surgery (impactions, root resections, dental implants)
- Surgery for Trauma of the Face (cranio-facial trauma)
- Treatment of Odontogenic Infections and Pathological Conditions of the Head and Neck
- Treatment of Cleft Lip and Palate (facial cleft deformities)
- Surgery for Orthognathic Deformities, Reconstruction, Aesthetics
- Treatment of Temporomandibular Joint Problems and Facial Pain.

As a largely clinical department, there are a number of clinics hosted within these subdivisions. The most prominent is the Facial Cleft Deformity (FCD) Clinic, headed by Dr Naidoo.

Founded in 1983, the FCD celebrated its 35th birthday in 2018. The Clinic had treated close on 5 000 patients over this 35-year timespan. In 2011, the FCD was recognised as an international team by the American Cleft Lip Palate Association (ACAP), the only African team to have received this accolade.



The Clinic follows a multidisciplinary approach in the treatment of patients and has implemented a strict comprehensive therapy protocol for the treatment of children with facial cleft deformities that aims to achieve optimal function and development of the patient's facial growth. A team of medical professionals, which includes maxillo-facial and oral surgeons, orthodontists, paediatricians, community health nurses, clinical psychologists, communication pathologists, audiologists, genetic counsellors, paedodontists, prosthodontists, oral hygienists and dental technicians, work closely together at various stages of the treatment process.

The protocol followed at the Clinic requires that surgical interventions take place at specific critical stages during the first year of the patient's life, but ultimately the extent of treatment required depends on how severe the condition is at birth. A small deformity for example, may need only one operation in the first months of life, while a child with a large cleft involving the lip and palate will need several operations and ongoing treatment from the team over a number of years. As a result of the surgical success rate and the excellent national and international reputation of the Clinic, many infants from poor socio-economic backgrounds and previously disadvantaged communities are referred to the Clinic from both other South African provinces and abroad. Patients without medical aid (which is about 80% of patients treated at the Clinic) are operated on at the Steve Biko Academic Hospital and the UP Oral Health Centre.

Research published in peer-reviewed or refereed journals covered a range of topics, and at least 29 articles were published between 2012 and 2018. The topics ranged from cleft-palate related surgery to relevant case reports and surgical interventions. Much of the research conducted in the Department formed part of specialist training in Oral Surgery.

## 4. Odontology

Prof Francois (FA) de Wet filled the role of Head of Department of Odontology from 2008 to 2016. In June 2014, Prof de Wet was awarded the prestigious Distinguished Service Award of the International Association of Dental Research, an award which had only been granted to 18 of its 12 000 members (and the only South African) at the time. When Prof de Wet retired, Dr Riaan (R) Lombard assumed the role of Acting Head from 2017 to 2018. In February 2019, a new Head of Department, Prof Zunaid (ZI) Vally was appointed.

The Department of Odontology, established in 2007, is the largest department in the School of Dentistry. It consists of five divisions:

- Basic Restorative Dentistry — Head: Dr Riaan Lombard
- Endodontics — Head: Dr Nichola (N) Warren
- Dental Materials — Head: Dr Paul (PD) Brandt
- Paedodontics — Acting Head: Dr Nicoline (N) Potgieter
- Curricular Matters — Head: Dr Vinesh (V) Bookhan.

During the review period, the Department continued with its focus on training students in a number of bread-and-butter aspects (i.e., areas where dentists in private dentistry spend most of their time), and continued to produce world-class students in these areas. The Department's curricular division ensured that current, innovative teaching methods were implemented and that the Department's curricula were in line with the best dental practice internationally.

Staff were actively involved in various aspects of dental research. The Department published 36 research articles in accredited journals from 2012 to 2018. In 2015, Dr Dorette Kritzinger won the Colgate Postgraduate research competition of the South African division of the International Association for Dental Research for her MSc (Odont) research, 'The effect of different polishing systems on the surface roughness of a nanocomposite and a microhybrid composite'. She competed against postgraduate students from all four dental schools in South Africa. Her supervisors were Dr Brandt and Prof De Wet.

In 2018, the Department of Odontology celebrated the achievements of four staff members who completed their postgraduate studies. Prof Peet (PJ) van der Vyver, appointed as an extraordinary professor in the Department, obtained his PhD degree with a thesis titled, 'A Micro-computed tomographic evaluation of curved maxillary molar root canals after using different root canal instrumentation techniques'. Three lecturers received their MSc Odont degrees, namely, Dr Martin (M) Vorster (Endodontics), Dr Nicoline Potgieter (Paedodontics) and Dr Glynn (GD) Buchanan (Endodontics).

## 5. Oral Pathology and Oral Biology

For the entire period under review, Prof Willie (WFP) van Heerden was the Head of Department of Oral Pathology and Oral Biology. In 2009, the Department took over Radiography, which was renamed Diagnostic Imaging, in keeping with contemporary trends.

The Department consists of six divisions:

- Oral Pathology — Head: Dr Belinda (BK) Bunn (2011–2018)
- Anatomical Pathology — Head: Dr Tsholofelo (T) Kungoane (2015–)
- Forensic Odontology — Prof Herman (H) Bernitz in a research capacity
- Oral Biology — Head: Dr Sonya (S) Boy (1998–2014); Dr Sulette (S) Nel is the current module coordinator for Oral Biology (2014–), supported by Dr Christy (C) Davidson (2012–)
- Diagnostic Imaging — Head: Dr Andre (A) Uys (2009–2018), succeeded by Dr Shoayeb (S) Shaik.

The Department was also involved in community outreach, through the Paediatric HIV Clinic at Kalafong Hospital, and continued to offer a biopsy service to all patients with head and neck lesions who attended the Oral and Dental Hospital and the Steve Biko Academic Hospital.

The Department produced high quality research outputs, with 77 accredited outputs from 2012 to 2018. International collaboration remained important with institutions including the University of Sheffield (UK), and the University of Campinas (Brazil). Prof Van Heerden served on the Council of the International Association of Oral Pathologists and as President of this Association from 2010 to 2012. He received UP's Education Innovation Award on two occasions and also the University's Exceptional Academic Achievers' Award.

Prof Herman Bernitz served as the President of the International Organisation for Forensic Odonto-Stomatology (IOFOS) from 2005 to 2011. His particular interest in bite mark analysis and mass disaster identification saw his appointment as chairperson of the 'bite mark' working group in Lillehammer, Norway where the international standards in bite mark analysis were set. Publications by Prof Bernitz included:

- In 2015, the section titled, 'Odontology: bite mark analysis,' which explains the medico-legal applications of bite marks and their analysis in forensic cases, was published in the *Encyclopedia of Forensic and Legal Medicine*, which comprises four volumes.
- In the same year, a book chapter in *The Global Practice of Forensic Science*, edited by Douglas H Ubelaker (1st ed, 2015, Wiley-Blackwell). Chapter 23, 'The history and current status of forensic science in South Africa', documents the history of forensic science in South Africa. Co-authored with colleagues in several disciplines of Forensic Science, the chapter details the legal

aspects pertaining to Forensic Odontology as well as the education, training and application of the sciences of Forensic Medicine, Forensic Anthropology, Forensic Toxicology and Forensic Ballistics.

In 2018, Prof Bernitz was invited to present a plenary lecture at the International Academy of Legal Medicine conference held in Fukuoka, Japan.

In the education resources sector, the Department successfully adapted the CD-ROM, *Oral and Maxillofacial Pathology* (2005) to mobile app format. The mobile app was developed in partnership with the Department of Education Innovation at UP and was released in 2017. The visuals and information presented in the app provide an essential adjunct to the head and neck pathology curricula for both undergraduate and postgraduate medical and dental students. The integration of the clinicopathological features and treatment principles makes for a unique and dynamic educational and clinical resource.

The app features clinical, macroscopic and microscopic images of a range of pathological lesions and conditions affecting bone, soft tissue and dental hard tissue of the head and neck region. It is easy to use and provides a quick on-the-go referencing system for the identification of patient signs and symptoms to facilitate clinical diagnosis and patient work-up. It also describes the required treatment for all conditions, including pharmacological management where applicable.

## 6. Orthodontics

Prof Antoinette (A) du Toit served as Acting Head of the Department of Orthodontics from 2000 to 2008 and was supported by Prof Piet (P) Botha who directed the MChD programme. The position of Head of Department was permanently filled in 2009 by Prof Phumzile (P) Hlongwa, who was the first black woman appointed in this position. In 2010, Prof Hlongwa took up a position at the University of Witwatersrand, and Prof Salahuddin (S) Dawjee was appointed as Head of the Department of Orthodontics at UP until the end of the review period, and beyond.

The discipline of Orthodontics focuses on aligning teeth and enhancing the patient's facial appearance. Orthodontic treatment contributes considerably to the patient's self-perception and well-being. Nationally, the demand for orthodontic treatment is high and this was manifest in a five-to seven-year waiting list for patients seeking treatment from the Department of Orthodontics at the University of Pretoria. In order to address this problem, the Department targeted

children with an urgent need for treatment, maximising the psychological comfort that orthodontic treatment can render.

The Department of Orthodontics strove toward excellence in teaching and training at both under- and postgraduate levels, extending and uplifting orthodontic treatment in the private and public sectors. At the undergraduate level, Orthodontics was introduced at the start of the third year and continued through to the final year of the BChD curriculum. Postgraduate courses included a Postgraduate Diploma in Dentistry (Orthodontics), an MScDent, an MChD and a PhD.

Research in the Department remained an important component of postgraduate training, and has been directed at finding affordable orthodontic solutions for problems particular to the African context. In addressing the three tiers of health care, viz. service rendering, teaching and research, the Department of Orthodontics made a meaningful contribution to orofacial health, both nationally and internationally.

## 7. Periodontics and Oral Medicine

Prof André (AW) van Zyl was appointed Head of the Department of Periodontics and Oral Medicine in August 2006, a post he held until early 2018. Prof Johan (J) Marnewick stood in as Acting Head until the end of the review period.

The Department of Periodontology and Oral Medicine comprised a staff complement of four full-time and three part-time specialists, and five registrars; and had sufficient support staff, and adequately up-to-date equipment and teaching facilities.

The Department ran three primary Clinics during the review period, namely:

- The Periodontics Clinic — Head: Dr Elmine (E) Crafford
- The Implant Clinic — Head: Prof Johan Marnewick
- The Oral Medicine Clinic — Head: Dr Jeanine (J) Fourie.

The Periodontics Clinic treats periodontal disease and morphological defects of the periodontium. Periodontitis has an infective aetiology and results in the destruction of the supporting structures of the tooth which may eventually result in the loss of the tooth. A well-documented relationship exists between periodontitis and systemic health and establishing periodontal health is of greater importance than just tooth maintenance. Alternatively, conditions that compromise the immunity of patients may cause painful and destructive

periodontal disease, resulting in necrosis of the gum, bone and surrounding soft tissue. The Clinic supports and treats these patients. In addition, morphological defects of the gum margin may result in aesthetic and functional concerns. Periodontal plastic procedures focus on re-establishing of gingival harmony and an aesthetically pleasing smile.

Replacing missing teeth by implants is a popular and viable treatment modality, although not always uncomplicated. The Implant Clinic assesses the viability of implant placement and in suitable candidates performs the placement of implants where they can functionally support a dental prosthesis. In some instances, additional surgery is performed to create an optimal bony and soft tissue environment for the future implant. Yet, as these implants have replaced failed teeth, so too can implants suffer from complications. In this instance the Clinic assists with the rehabilitation or removal of such implants.

The Oral Medicine Clinic is primarily involved in diagnosing and managing soft tissue conditions of the mouth which either requires simple surgical resection as a diagnostic and curative modality or the employment of pharmacological approaches in the management of the condition. Such conditions include infections (viral, fungal and bacterial), lesions that are reactive to common irritants in the mouth, the consequence of systemic diseases or medication use, or the result of a dysfunctional immune system. Most of these patients complain of sores and tenderness in their mouths.

In addition, help is given to those patients who suffer from dryness of their mouths or a burning sensation of the lining of the mouth. Advanced diagnostic aids are used to assess lesions that may possibly be malignant, and the long-term monitoring of patients who have experienced early precursor lesions to oral cancer as well as successfully treated oral cancer patients.

In 2013, the Department was awarded an International Team for Implantology (ITI) Centre of Excellence (one of eight in the world) and an ITI Scholarship Centre (one of 21 in the world). The ITI Centre of Excellence held annual training sessions in implantology from 2014 until 2017.

## 8. Prosthodontics

Prof Hemant (HD) Dullabh was, since 2007, at the helm of the Department of Prosthodontics with Prof Leanne (L) Sykes and Prof Cules (H) van den Heever, largely responsible for the treatment of patients requiring prosthodontic treatment.

The Department of Prosthodontics is one of only a few centres in South Africa where specialised maxillo-facial prosthodontics services are offered to state patients. The maxillo-facial prosthodontics project, which is run by staff in the Department, is multidisciplinary in nature and includes the services of a team of specialists consisting of maxillo-facial surgeons, plastic surgeons, ear, nose and throat (ENT) specialists, and in cases involving patients suffering from cancer, oncologists and radiotherapists. As part of an extended rehabilitation programme after surgery, the services of a speech or language therapist may also be enlisted.

Most patients are adults suffering from oral or head and neck defects due to trauma, cancer or congenital anomalies, who have been referred from the Steve Biko Academic Hospital, as well as from many of the surrounding clinics in Gauteng, Limpopo and Mpumalanga. The restorative work undertaken by the team to date has included implanting jaw prostheses, manufacturing dental prostheses and obturators (which are dental prostheses used to seal openings in the palate, such as is needed in babies with cleft palates) and constructing extra-oral appliances such as prosthetic eyes, ears and noses. Regular follow-up treatments for maintenance or replacement of prostheses due to normal wear and tear, or in some cases due to the changing shapes of the defects after healing or following recurrences, are an integral part of the service offered by the team.

Research during the period under review includes investigations into advances in the use of computer-aided treatment planning. This technology will enable surgeons to better plan the best course of treatment and could potentially minimise the number of times a patient has to endure complex surgeries. Closely related to this is research in 3D framework design and fabrication of prostheses, rapid prototyping and 3D printing, as well as the design of new materials that can be used in the manufacturing of prostheses. These technological advances are useful aids in the treatment and planning of complex surgical cases and will allow specialists to manufacture prostheses that can better fulfil the complex needs of maxillo-facial patients. Another area that was being investigated by researchers at the Department is zygomatic implants. These are used in the upper jaw when there is insufficient bone for conventional implants. They provide support for implant bridgework where there has been a substantial amount of bone loss.

The work done by the team at the Department of Prosthodontics draws from many different academic disciplines, but the overarching goal of the surgical work they

do and the research they undertake has remained to effect a lasting change in the lives of the patients they treat.

## SCHOOL OF HEALTH CARE SCIENCES

Established in 2001, the School of Healthcare Sciences (SHCS) is one of the four schools of the Faculty of Health Sciences. The SHCS comprises five departments, namely, Human Nutrition, Nursing Science, Occupational Therapy, Physiotherapy and Radiographic Sciences. The School was, and remained, the second largest school in the Faculty. The concept 'care' differentiated the SHCS from the other schools and departments, with the name chosen to emphasise this aspect that distinguishes the Departments in the School.

Previously the School used a committee system to ensure the proper functioning of the School and to ensure the sharing of skills and expertise between members of different departments. It consisted of five committees: Research and Postgraduate Committee, Community Engagement and Research Committee, Human Resource Development Committee, Marketing Committee and the Education: Undergraduate Committee. In December 2013, the SHCS conducted a needs assessment and transformed the committee structure. The workshop was chaired by Prof Eric (E) Buch, the Dean of Health Sciences at the time.

Following this workshop, the SHCS identified new strategic goals, each with its own committee:

- Undergraduate and Postgraduate Teaching and Learning Committee
- Research Core Committee
- Community Engagement Committee
- Staff and Culture Committee
- Pre-Care, In-Care and Post-Care (of students) Committee
- Marketing and Fundraising Committee.

### Leadership

The second chairperson of the School, Prof Tania (AJ) van Rooyen, filled this position from 1 October 2007 until the end of 2011. She resigned this position when she was appointed as Head of Department of Physiotherapy, where she remained an academic staff member until 31 January 2018. Starting in 2012, Prof Fhumulani Mavis (FM) Mulaudzi steered the SHCS, and held the position of chairperson until the end of 2018 and beyond.



### Vision and mission

The School committed itself to implementing strategies for transforming and expanding the Faculty. During the review period the SHCS strove for excellent education in all the disciplines, and promoted scholarship by creating, advancing and preserving knowledge. The School stimulated critical and independent thinking in students to create flexible and lifelong learning. The SHCS encouraged academically rigorous research aligned with the health needs of South Africa. The School and all its disciplines continued to foster constructive involvement in the community. Community engagement developed students' leadership and social responsibility to become well-rounded, creative persons, who took responsibility for their respective professions and were focused on becoming future leaders.

### Undergraduate programmes

Each of the five departments offered undergraduate programmes in their area of speciality namely,

- Bachelor in Physiotherapy (BPhysio)
- Bachelor in Nursing (BNurs)
- Bachelor in Radiography (BRad)
- Bachelor in Occupational Therapy (BOT)
- Bachelor of Dietetics (BDietetics).

In 2009, the SHCS implemented a mentorship programme in which all five departments were involved by 2012. The Department of Occupational Therapy continued with a 'big sister' programme, forming part of the responsibilities of their student house committee. From 2013, all departments used second-year students as peer mentors, a model deemed most effective as second-years could help academically and were more likely to be on campus and in touch with first-years.

## DEPARTMENTS

### 1. Human Nutrition

For the whole review period, except in 2015, Gerda (GJ) Gericke filled the position of Head of Department of Human Nutrition. In 2015, Prof Friedeburg (F) Wenhold was appointed as Acting Head of Department. The Department grew from having four senior faculty members in 2008 to six in 2018.

Ms Gericke served on the Nestlé Nutrition Institute-Africa (NNIA) Board from 2010, and as Vice-Chair from 2017.

Initially, in 1994, Human Nutrition was established as a division in the Faculty of Medicine. It received departmental status in 2006. To keep pace with change and the demands of time, and to train internationally competitive dieticians with locally relevant skills, the Department revised the BDietetics curriculum twice, first in 1998 to 2000 and then from 2008 to 2010. The curriculum was revised in collaboration with stakeholders and the Professional Board for Dietetics. The new curriculum, introduced in 2010, is characterised by a problem-based approach to learning, lateral and vertical integration, as well as early and continuous practical exposure and training in practice — at primary, secondary and tertiary health care levels, as well as in private and/or government institutions.

The term 'human nutrition' shows directly and unambiguously that the science of nutrition applies to human beings in the interest of their health. It highlights the role of nutrition in a health-promoting, preventive, therapeutic, rehabilitative and/or palliative context. The new name was also deemed better for promoting interdisciplinary cooperation in the field of training, research and community development, because of its wider field of application.

The possibilities for postgraduate training in Dietetics (M Dietetics) consisted of a choice between a coursework master's programme, and a research master's degree where the research project is the essence of the training. In 1997, a coursework degree programme, MSc (Applied Human Nutrition), was approved as a qualification.

The research foci in the Department of Human Nutrition were directly linked to the professional competencies of staff, and included: public health community nutrition, medical nutritional care, food and managerial science as the basis of

nutrition care, the dietetic profession, nutrition behaviour and nutrition assessment.

The research areas in the Department were closely linked to UP's Institute for Food, Nutrition and Well-Being, with several staff involved, including, Gericke, Prof Wenhold, Dr Zelda (Z) White, Dr Heather (MH) Sidebe and Prof Una (UE) McIntyre.

Research highlights for the Department included the following:

- In 2009, Gerda Gericke and colleagues from the Faculty quantified the nutritional status and CD4 Cell count of HIV positive adults, in their work with outpatients from the antiretroviral (ARV) clinic at Dr George Mukhari Hospital in Ga-Rankuwa. This research revealed a dire need to improve the dietary quality of people living with HIV in low socio-economic settings.
- The nutritional needs and knowledge of people with type 2 diabetes have always been a research focus in the Department. In 2012, Dr Jane (JW) Muchiri and colleagues, Gerda Gericke (Human Nutrition) and Prof Paul (P) Rheeder (Clinical Medicine: School of Health Systems and Public Health) assessed the nutrition needs and preferences of adults with type 2 diabetes in a resource-limited setting in South Africa. They concluded that material traditionally formulated for western populations would need to be adapted to people living in resource-limited settings in Africa. Given that people living in such settings generally suffer poor health outcomes, they have a great need for nutrition programmes tailored to their level of knowledge and available resources.
- Much of the research in the Department was focused on school-based nutrition education programmes. In 2014, published in *Maternal and Child Nutrition*, Prof Wenhold (Human Nutrition) and colleagues, Prof McIntyre (Human Nutrition) and Prof Rheeder screened the dietary fat intake of Grade Six school children. The children completed an in-school pictorial, quantitative food frequency-type screening while mothers individually completed a text version. Interestingly, children consistently reported higher fat intake than their mothers, and both mothers and children reported high fat intakes which identified a need for refining measurement techniques and implementing primary prevention programmes.
- In 2013, staff in the Department published a paper in *Nutrition* on the factors that hinder the comparison of food intake data across studies.<sup>2</sup> They established that

<sup>2</sup> M Faber et al. 2013. Presentation and interpretation of food intake data: factors affecting comparability across studies. *Nutrition*. 2013, 29:1286-1292. <https://doi.org/10.1016/j.nut.2013.03.016>

comparing food data was complicated across studies in different settings and developed a checklist to strengthen the reporting of food intake data in science communication.

## 2. Nursing Science

The Department of Nursing Science, a pioneer in the nursing profession in South Africa, started the first undergraduate training of nursing scientists in 1956. Its trailblazing work kept pace with new technology and changes in the profession, and the Department continued to strive for innovative and sustainable responses to the diverse health needs of South African and African communities.

There were two Heads of Department during the review period, Prof Neltjie (NC) van Wyk who was Head of Department for 12 years (1997–2009) followed by the appointment of Prof Fumulani Mavis (FM) Mulaudzi (2010–2018). Prof Van Wyk also served as chairperson of the School of Health Care Sciences. She is still a staff member and now focuses on supervising master's and PhD students. Prof Mulaudzi received a Department of Science and Technology (DST) Women in Science Award in 2011 for her outstanding contribution towards building the South African scientific and research knowledge base.

During the review period, the Department's teaching and learning, research, and community engagement were transformed through the spirit of *Ubuntu* that fosters transdisciplinarity and transformative teaching and learning teams. The core activities of the Department were directed at being inclusive and responsive to the development, well-being and success of their students.

Below are examples that illustrate some of the achievement:

In 2012, the Department of Nursing Science and the University of Limpopo (Medunsa Campus) hosted a three-day Reproductive Health Care Workshop. Two international presenters contributed to the workshop, Dr Joyce (J) Cappiello (University of New Hampshire, US) and Prof Katherine (KE) Simmonds (Massachusetts General Hospital, Institute of Health Professions, US). The aim of the workshop, given the focus of the Department of Nursing on improving research capacity, was to support the Reproductive Health Community of Practice (CoP) in identifying research areas and to develop skills in action research.

Several international researchers have over time visited the Department of Nursing Science and provided much valued research expertise to the SHCS. In 2017, Prof Patricia (PJ) Kelly (University of Missouri-Kansas, US), presented five sessions on research related topics. Also in 2017, Prof Jaya (JR) Dantas from Curtin University (Australia), supported by a staff exchange programme, presented a series of workshops on developing research pathways. Prof Dantas' presentations highlighted the importance of securing grants and publishing in high impact journals for professional visibility.

Research themes included intimate partner violence, especially in the South African context. In 2016, Prof Annatjie (A) van der Wath and colleagues — Prof Neltjie van Wyk and Prof Elsie (ES) Janse van Rensburg (Unisa) — highlighted the plight of emergency nurses in supporting women who are suspected victims of intimate partner violence. Profs Van Wyk and Van der Wath also documented the experience of male nurses in caring for female victims of intimate partner violence. Published in *Contemporary Nurse* (2015), their research showed that men are not expected to be in the nursing profession and male nurses may therefore experience role conflict when caring for female patients.

Research also focused on the unique challenges associated with health care and health promotion in South African communities. Prof Mulaudzi and Prof Dorricah (MD) Peu published a review of the role of nurses in school health and communal child rearing in *Curationis* (2014). They concluded that nurses are integral to ensuring that children have access to health care, and that school health should be included in nursing curricula. Researchers from the Department, Dr Shirley (R) Mogale et al. (2017), also developed and tested a female condom, FC2, to promote gender equality and prevent HIV and AIDS. In 2017, research also explored, with the Department of Family Medicine, homelessness in the City of Tshwane, and showed that homelessness was directly driven by poverty.

Staff were actively engaged with surrounding communities, particularly members of the Department's Practice Development Community of Practice that included Dr Tanya (T) Heyns, Seugnette (S) Rossouw, Dr Isabel (IM) Coetzee, Varshika (V) Bhana and Celia (C) Filmalter. In 2012, they held a Child Safe event with Foundation Phase learners from Nigel Primary School. As nurses, they frequently observed burn wounds on children caused by fallen candles and identified a need to address this issue. The event used art, crafts and activities to teach children about candle safety.

## 3. Occupational Therapy

Occupational therapy is the art and science of guiding people with activity limitations to perform important daily activities (self-care, leisure and work tasks). This form of therapy optimises functional abilities so that people are able to participate in their communities, and often includes people with developmental delays, learning disabilities, physical and/or psycho-social dysfunctions.

In South Africa, occupational therapy training was first introduced through the School of Occupational Therapy in 1955. This then became the Pretoria College of Occupational Therapy in 1963. After the Principal, Vona du Toit, passed away in 1975, the College was renamed the Vona du Toit College of Occupational Therapy. In 1982, the College was incorporated into the University of Pretoria to form the Department of Occupational Therapy. Vona du Toit's legacy, the 'theory of creative ability', has become a feature of occupational therapy training in South Africa and forms the basis of therapeutic intervention in the various fields of the profession.

For the period under review, the Department of Occupational Therapy had four heads of department. Dr Margot (MS) Graham led the Department in 2008 and 2009. She was succeeded by Dr Marianne (M) de Beer who was in this leadership position from 2010 to 2015. Elsje (EP) Rudman stood in as Acting Head in 2016 and 2017, until the appointment of Prof Kitty (CJE) Uys as Head of Department in 2018.

Teaching in the Department has always been practice-based, with field work starting in the first year. The four-year degree (BOccTher) applies the basic principles of Anatomy and Psychology in practical settings. The Department also offered two postgraduate diplomas, one in hand therapy accredited by the South African Society of Hand Therapists (SASHT), and one in vocational rehabilitation. Postgraduate studies at master's and doctoral levels were also offered during this time.

There were several research highlights in this review period. The following illustrates:

- In 2014, Dr Tania (T) Buys co-authored a book chapter titled, 'Vocational rehabilitation in psychiatry and mental health', in R Crouch and V Alers (eds), *Occupational Therapy*

in *Psychiatry and Mental Health*<sup>3</sup>. She also presented numerous conference papers.

- Renate (R) Schoeman, a second-year occupational therapy student, won the 2016 International Science Centre and Science Museum Day Contest, and was chosen to participate in a UNESCO conference in Paris (France), celebrating World Science Day for Peace and Development.
- In 2016, Dr Enos (E) Ramano, Dr Tania Buys and Dr Marianne de Beer published research focused on formulating a return-to-work decision for employees with major depressive disorder.
- In 2017, Dr Ramano and colleagues explored the use of two occupational therapy group programmes on the functioning of patients with major depressive disorder. Published in *Minerva Psichiatrica*, their work made valuable contributions to the treatment of such patients.
- Also in 2017, two Occupational Therapy students participated in a student exchange programme with Sahlgrenska Academy at the University of Gothenburg (Sweden). Rulaine (R) Smith was the first lecturer to participate in a lecturer exchange programme with the same university when, in 2011, she was a visiting lecturer on work rehabilitation.

The Department of Occupational Therapy also contributed to community engagement. In 2011, the Department started the Siyathemba Paediatric Clinic, a clinic that provides free occupational therapy services to children and teenagers with physical as well as learning disabilities. Fourth-year Occupational Therapy students were also involved with the Mamelodi Association for People with Disabilities, tending to community gardens and revamping playgrounds.

The Department has always featured strongly in community engagement in the School of Health Care Sciences (SHCS). Working with the departments of Nursing Science, Human Nutrition and Physiotherapy on World Hypertension Day in 2013, students and staff from Occupational Therapy screened the blood pressure of 154 men and women at Denneboom Taxi Rank in Pretoria. Thirty-five people were referred to the nearest clinic for blood pressure re-checking and further management. Students also checked the blood pressure of 40 elderly clients at Charity Church, with some referred to clinics for further management. This was the first collaborative outreach from the SHCS and heralded the beginning of

<sup>3</sup> Wiley Online Library, see <https://doi.org/10.1002/9781118913536.ch12>

continuous collaborative community engagement activities. Also in 2013, students and staff from the departments of Nursing Science, Human Nutrition and Occupational Therapy celebrated breastfeeding awareness week at Stanza Bopape Community Health Centre in Mamelodi. Activities included health education, advice and demonstrations.

#### 4. Physiotherapy

Physiotherapy education started as a three-year National Diploma in Physiotherapy in 1950. The diploma was converted to a four-year bachelor's degree in 1981 and was still offered in that form in the review period. The degree is a professional entry qualification to the physiotherapy profession as one of the registered health care professions at the Health Professions Council of South Africa (HPCSA).

The Department of Physiotherapy has pursued a holistic and comprehensive approach to patient care from all walks of life, emphasising the promotion, prevention, maintenance and restoration of individuals, as well as communities' physical, psychological and social well-being. The Department of Physiotherapy has a strong training focus, and prepares physiotherapists to be involved in all forms of physiotherapy.

From 2008 to 2013, Prof Tania (AJ) van Rooijen was the Head of Department of the Department of Physiotherapy. She was promoted to professor in 2012. From 2014 to 2018, the position of Head of Department was filled by Prof Joyce (DJ) Mothabeng. Prof Mothabeng's research and teaching has focused on disability and rehabilitation, with special interest in spinal cord injury rehabilitation. She is actively involved in the Southern Africa Spinal Cord Association (SASCA) and is a member of the International Spinal Cord Society (ISCoS).

The following are some of the research highlights:

- In 2015, Karien (K) Mostert-Wentzel and co-authors received the World Confederation for Physical Therapy (WCPT) outstanding platform presentation award for the Africa region, for the abstract, 'The kaleidoscope curriculum framework for community and public health physiotherapy in South Africa'. The co-authors were José (JM) Frantz, Steve (S) Olorunju and Tania van Rooijen.
- In 2017, Prof Mothabeng and colleagues published an epidemiological report on the prevalence of spinal cord injury in South Africa in the *American Journal of Physical Medicine & Rehabilitation*. In South Africa, epidemiological data on spinal cord injury (SCI) are scarce, partly owing to the lack of a national registry and a coordinated system of

care. Traumatic spinal cord injury (TSCI) was reported to be a staggering 75,6 per million persons. The main cause of TSCI in South Africa was found to be assault, which accounted for approximately 60% of all cases, followed by transport related causes (26%) and falls (12%).

- In 2018, Prof Van Rooijen and colleagues evaluated the role of upper-limb strength and ergonomics in predicting successful extubation in mechanically ventilated patients. Published in the *Southern African Journal of Critical Care*, they concluded that strong neck and upper deltoid muscles, as well as endurance, were predictors of successful extubation.
- Researchers in the Department of Physiotherapy have also been involved in research in other African countries. In 2014, Vivienne (VRP) M'Kumbuzi, Jean Baptiste (JB) Sagahutu, Jean (JN) Kagwiza, Gerard (G) Urimubenshi, and Karien Mostert-Wentzel described the emerging pattern of disability in Rwanda, in the journal *Disability and Rehabilitation*. In two districts in Rwanda, adults had a higher prevalence of disability compared to children, with the most common disability being visual impairment followed by mobility and mental health functions.

The Department's engagement and outreach activities were strongly pursued, for example:

In 2012, Bafana (BH) Sihlali, a staff member of the Department of Physiotherapy, served on the medical team of Team South Africa at the London Olympic Games. Mr Sihlali was the chief physiotherapist of a team of nine physiotherapists who treated and supported athletes. The medical team served 125 athletes from various sporting codes. Mr Sihlali's main interest is sports physiotherapy and he has served as a physiotherapist on the medical teams of three Paralympic Games since 2000. He has also supported athletes in other national and international events, including the FIFA World Cup 2010. His experience at national and international levels reflects the high standard of clinical training of physiotherapy students at UP. Mr Sihlali is a proud postgraduate alumnus of the University.

In 2016, four alumni of the Department of Physiotherapy formed part of the medical team that accompanied Team South Africa to the Rio Olympics and Paralympics — Tarina (T) Stockt, Colin (C) Hill, Kobus (K) Maree and Khuliso (K) Netshivhangani. Tarina and Khuliso were part of the Paralympics medical team, while Colin Hill and Kobus Maree joined the Olympics medical team.

In 2018, Physiotherapy students supported athletes at the 2018 Comrades Marathon, thereby gaining much needed



experience. Guided by qualified physiotherapists, final-year students treated everything from calf, hamstring, quads, glutes, groins, backs, necks, knees, ankles and medial arches.

The Tuks Physiotherapy team participated in the annual Strap for Life competition with students from universities across South Africa; the UP team came second in this competition.

#### 5. Radiography

Established in 1998, the Department of Radiography offers an undergraduate programme in Diagnostic Radiography and postgraduate programmes in Diagnostic Radiography and Radiation Therapy.

The Department has maintained academic excellence through its education and research in field-specific areas in Radiography. It also continues to participate in community engagement projects in diverse clinical training facilities, in addition to contributing to the professional community and patient service delivery. Radiography students are trained in facilities located in the public and private sector.

The Department's staff and field expertise are in mammography, image interpretation, interventional radiology, quality management, magnetic resonance imaging and computerised tomography (CT). For Radiation Therapy, areas of expertise include brachytherapy, IMRT, VMED, total body photon radiotherapy, total skin irradiation and stereotactic radiotherapy. For Nuclear Medicine, areas of expertise include PET/CT, SPECT and SPECT/CT, peptide receptor radiation therapy as well as thyroid imaging and treatment.

Annarie (GA) Hugo was Head of Department from 2008 to 2009, a role that she fulfilled since the inception of the Department. Dr Chandra (CR) Makanjee was Head of Department from 2010 to 2015, and was succeeded by Dr Mable (RM) Kekana, who continued in this position beyond 2018.

The Department went from strength to strength in research and publications, attracting local and international postgraduate students. In line with the University's strategic goals, the Department focused on strengthening Africa's professional profile and meeting national needs in terms of

diagnostic, nuclear medicine and radiation therapy health care services. The Department's core strength lay in its holistic approach and nurturing environment, supported by a strong learner-centred and people-centred approach.

Radiography learners actively participated in managing the educational programme. As part of the School of Health Care Sciences (SHCS), staff members participated in shared modules such as the Integrated Healthcare Leadership and Research in Healthcare.

The Department of Radiography has maintained a steady intake of around 40 students per annum. Historically, the intake has always been limited by the available clinical training facilities. Having a manageable number of students provides opportunities for close working relations between students, lecturers and clinical supervisors.

The Department saw significant growth in terms of research, going from no outputs during the previous review period to 20 research articles during this period:

- In 2010, Dr Kekana explored the ethics behind the use of telemedicine in relieving health care shortages in South Africa. She concluded that the regulatory bodies, such as the HPCSA, needed to consider potential misconduct in the form of inappropriate billing and inadequate care before adopting telemedicine as a routine form of care. This was published in the *South African Journal of Bioethics and Law*, with co-authors Pitso (P) Noe and Boyce (B) Mkhize.
- Dr Chandra Makanjee, published a number of papers in journals such as *Radiography* and the *Journal of Radiology Nursing*. Her research focused on the delivery of radiographic services in South African health care settings. In 2015, Dr Makanjee, Anne-Marie (AM) Bergh (SAMRC Unit for Maternal and Infant Health Care Strategies) and Willem (WA) Hoffman (Tshwane University of Technology) explored in a qualitative study how the results of medical imaging examinations are conveyed within a public health care complex. They concluded that there is a moral and ethical obligation to provide patients with clear and timeous feedback. At the time when this study was published, there was still a need to improve on communication.
- In 2015, Phillipa (PL) Bresser and colleagues investigated the variability of left ventricular ejection fraction using manual and automatic processing modes. This was published in *Radiography*. Planar multi-gated cardiac blood pool acquisition is often used to non-invasively measure

left ventricular ejection fraction (LVEF), either manually or automatically. They concluded that automatic processing be used to determine LVEF to limit inter-operator variability.

- In 2017, Phillipa Bresser and colleagues from the University conducted a randomised-controlled study of a modified technique to reduce extracardiac activity in myocardial perfusion imaging, published in *Nuclear Medicine Communications*. They found that combining interventions that stimulate radiopharmaceutical hepatic excretion improves myocardial perfusion imaging, with delayed imaging being advocated as a complementary intervention. These interventions include drinking lemon juice and soda water, which are easily implemented in a clinical setting.

## SCHOOL OF HEALTH SYSTEMS AND PUBLIC HEALTH

The School of Health Systems and Public Health (SHSPH) is a dynamic and vibrant teaching and learning, as well as research-focused school in the Faculty of Health Sciences. Established in 1998 as a department in the School of Medicine, the SHSPH aims to enhance the University's ability to engage one of society's most valued goals — health.

One of the four schools of the Faculty of Health Sciences, the SHSPH is a 'horizontal' school: accessing and strengthening any area relevant to the health system and to public health. The School has an outcomes-orientated structure and function — a better health system and greater health that is more equally distributed. The nature of the SHSPH is, by definition, multidisciplinary; staff are recruited from a number of disciplines and faculties at the University, as well as from outside institutions and organisations.

The SHSPH has retained its historical structure with a single department, the Department of Public Health Medicine and four research streams. By 2009, the specialisations in the School were as follows:

- Epidemiology and Biostatistics — headed by Prof Maila John (MJ) Matjila
- Health Policy and Management — headed by Prof Eric (E) Buch
- Environmental and Occupational Health — headed by Prof Kuku (K) Voyi
- Disease Control — headed by Dr Bernice (B) Harris



Medical graduates' sworn in ceremony, 2016

- Health Promotion — headed by Dr Kirstie (K) Rendall-Mkosi.

The SHSPH offers postgraduate modules focusing on these areas of specialisation. Modules are generally extended over one academic week, with pre-reading and post-module assignments. All master's students have to complete a required set of core modules covering the breadth of public health, and the remaining half of their credits in disease prevention and control, environmental and occupational health, health management sciences, health measurement sciences, health promotion or monitoring and evaluation.

The School also offers research master's and doctoral degrees.

The Department of Public Health Medicine remains the link between clinical medicine and public health, and still forms an integral part of the SHSPH. By 2010, the School was responsible for undergraduate teaching at the first, second, fourth and fifth years of training. Students were introduced to environmental health in their first block. Second-year students

were trained in epidemiologic principles and methods, public health principles, and communicable disease control measures in the second half of the year; while the fourth- and fifth-year students were introduced to the theory and practice of district health systems and primary health.

The fifth year, Block 16, was run in collaboration with the Family Medicine Department. The block was converted from a class-based didactic module to an academic service learning module. This shift was partly in response to the University of Pretoria's emphasis on community engagement — of which academic service learning is the key example — but also based on literature and identified needs of the SHSPH's own students and academic staff. This revised module showed significant improvement, based on student feedback and additional evaluation, and was one of the top-rated modules in the undergraduate medical curriculum. In 2008 and 2010 this module won the Certificate for Education Innovation Award from UP.

By 2012, the SHSPH had various postgraduate offerings including:

- Diploma in Tropical Medicine and Health (DTM&H)
- Diploma in Public Health Medicine (DipPHM)
- Diploma in Public Health (DPH), non-clinical
- Diploma in Health Systems Management (DHSM), non-clinical
- Diploma in Occupational Medicine and Health (DOMH)
- Diploma in Occupational Health (DipOH), non-clinical
- MPH in Biostatistics and Epidemiology (Subtrack: MPH in Monitoring and Evaluation; and MPH in Field Epidemiology and Laboratory Training)
- MPH in Disease Control
- MPH in Environmental and Occupational Health
- MPH in Health Policy and Management
- MPH in Health Promotion
- Magister Scientiae (MSc) with limited coursework and a major research component in:
  - MSc in Clinical Epidemiology
  - MSc in Community Health
  - MSc in Epidemiology
  - MSc in Biostatistics (Public Health)
- MMed (Public Health Medicine) for medical doctors only.

The SHSPH saw various leaders taking the helm from 2009 to 2018. Prof Kuku Voyi was appointed as the first chairperson of SHSPH in 2004 and served in this capacity until April 2010. Prof Tiaan (C) de Jager took the helm in 2010 and held the position until early 2012. Dr Kristie Rendall-Mkosi held the position for a short while in 2012 and was then followed by Prof Paul (P) Rheeder who was acting chairperson in 2013 and 2014. The position of chairperson was vacant in 2015. From 2016 to 2018, Prof Voyi assumed the role of chairperson, until Dr Flavia (F) Senkubuge assumed the role of acting chair in 2018.

## DEPARTMENTS

### 1. Public Health Medicine

Established in the 1980s, the Department of Public Health Medicine was responsible for coordinating undergraduate

teaching in the Faculty of Health Sciences, as well as running the postgraduate programme, MMed Public Health Medicine. The Head of Department from 2008 to 2012, was Prof Maila (MJ) Matjila. The post remained vacant for two years, until Prof Debashis (D) Basu took the helm, a position which he held up to 2018, and beyond.

In terms of services, the Departmental staff — public health medicine specialists, registrars and medical officers, and clinical associates — provide clinical services to the Steve Biko Academic Hospital and its cluster health facilities, including the Tembisa Provincial Tertiary Hospital. In addition, the Departmental staff support the initiatives of the Gauteng Provincial Department of Health and the South African National Department of Health.

Its activities could broadly be grouped into:

- Disease prevention — communicable diseases, non-communicable diseases, maternal and child health
- Clinical public health — clinical health informatics, medical management, clinical economics
- Occupational and environmental health and social medicine.

The Department also supported a wide range of research aimed at advancing public health and preventive medicine practice as well as having many collaborations with other research institutions, government and NGO services.

The Department was closely linked to the UP Community Oriented Primary Care (COPC) Research Unit, as well as the WHO Collaborating Centre for Social Determinants of Health and Health in All Policies.

## SCHOOL OF MEDICINE

The School of Medicine (SoM) remained the largest school in the Faculty of Health Sciences, and continued to focus strongly on its clinical offering. The SoM had three basic science disciplines — Anatomy, Physiology and Immunology — in which staff were employed by UP; the other 25 departments were based on joint appointment arrangements with Gauteng Department of Health (DoH), the National Health Laboratory Service (NHLS), and to a smaller degree, Mpumalanga DoH.

Prof Gerhard (BG) Lindeque was the chairperson of the School until the end of 2017. He was succeeded by Prof Robin (RJ) Green in 2018. The School was managed by an Executive Committee, which was elected every two years. Members of

### Aerospace Medicine Division

2012 saw the incorporation of the Aerospace Medicine Division into the SHSPH. Lt Col (Dr) Wynand Murray retired on 31 May 2012 after being the head of the Aerospace Medicine Division from 2007 to 2012. He was replaced by Col (Dr) Chris Blunden, who was the head of the division from 2012 for the entire review period (2018, and beyond).

Over time, it was realised that aviation medicine encompassed more than just the individual doctor-patient relationship and that there was a pressing need to prepare health care professionals to ensure the optimal health and well-being of entire populations of pilots, aircrew members, passengers and patients in the global aerospace environment. It is for this reason that aerospace medicine was perceived by the international community as belonging in the occupational health/public health domain.

It was thus decided to move the Aerospace Medicine Division, including the postgraduate programmes, from the School of Medicine to the SHSPH, in line with international best practice.

### The Albertina Sisulu Executive Leadership Programme in Health

In 2012, the Albertina Sisulu Executive Leadership Programme in Health (ASELPH) garnered its first major funding. The ASELPH programme was developed by Prof Eric Buch, in collaboration with the Harvard School of Public Health and the Faculty of Health Sciences at Fort Hare University, for capacity building programmes in health management over the next five years. Prof Stephen (S) Hendriks was the first Director of the ASELPH. The ASELPH was officially launched in 2014.

There were several highlights in this period, some of which are listed here:

In 2015, Moses (MM) Kebalepile, an SHSPH student won the overall prize in the Technology Innovation Agency (TIA) Inventors Garage Competition for his hand-held asthma grid which can predict asthma attacks. In 2017, Mr Kebalepile was awarded at the International Pitchfest of the SwissSA Venture Leaders Programme for the medical diagnostic instrument — the Asthma Grid. He also won the 2016 Gauteng Accelerator Programme (GAP) Innovation Competition.

Prof Matjila and Prof Buch were both awarded PHILA Lifetime Achievement awards at the Public Health Association of South Africa (PHASA) in 2015.

In 2018, Dr Flavia Senkubuge was elected President of the Colleges of Medicine of South Africa (CMSA). Dr Senkubuge was the youngest president of the CMSA and the first specialist in public health medicine to hold the position. She was also the first black woman and the third woman in the CMSA's 64-year history to be appointed president.

The UP ISMC team, led by its Director, Prof Tiaan de Jager, was crowned the winner of the 2017/2018 NSTF-South 32 Award in the category: Communication for outreach and creating awareness of SET and innovation by a team or individual over the past five years.

the School were Prof Lindeque (chairperson of School), Prof Leonara (L) Dreyer, Prof Mariana (M) Kruger, and Prof Jan (JH) Meiring.

The most significant offerings of the SoM remained the MBChB (Medicine) and MMed programmes. The programmes have attracted many students due to their robust and compelling practical application and intensely hands-on skills training afforded alongside excellent research-driven theoretical components. All the programmes in the School of Medicine continued to be accredited by the Health Professions Council of South Africa (HPCSA).

A major development during the review period was the introduction of the Bachelor of Clinical Medical Practice (BCMP) degree, which saw its first intake of students in 2009, and the first graduates in 2011.

During the period under review, the class sizes of the MBChB programme grew from 220 students to 300 students to meet the increased national demand. The Faculty had to accommodate students at the traditional training sites, Steve Biko Academic Hospital (SBAH), Kalafong Academic Hospital (KAH), as the departments in Tembisa and in Mamelodi Hospital had not yet been developed. The same held true for

the sites in Mpumalanga (Witbank and Rob Ferreira). Smaller departments, including Urology, Neurology, Ophthalmology, Ear, Nose and Throat, Psychiatry, and Anaesthesiology especially felt the burden of large student numbers, although none of the departments were immune from the effects of increased class sizes.

The SoM moved forward by using private sector rotations of undergraduate students in specific practices (for accreditation) in the disciplines where problems were acute. It was fortunate that UP had many prospective partners and stakeholders who were keen to be associated with UP's School of Medicine.

In this review period, several clinical training opportunities were established:

- Netcare offered opportunities linked to cardiologists.
- Wilgers Consortium Hospital offered opportunities linked to neurology.
- UP's Sport, Exercise Medicine and Lifestyle Research Institute (SEMLI) offered rotation opportunities with the Zuid-Afrikaanse Hospital in the area of sport-based medical research.
- The Urology Hospital offered collaboration for training of urologists as well as research opportunities in the endocrine cancers domain.
- Similarly, funded through the Clinical Training Grant, a training and service platform in Ophthalmology was established at the Pretoria West Hospital with high numbers of patients being assisted.

The MMed offering has benefited from continued investment by Netcare, Discovery and Mediclinic in the training and appointment of specialty medical fellows.

During the period under review, the Faculty of Health Sciences had at least five Netcare-funded subspecialty medical fellows, two Discovery-funded fellows and one Mediclinic-funded fellow. The School of Medicine received a donation of camera equipment with endoscopic instrumentation from Karl Storz GmbH & Co.KG to the value of R8 million. The camera equipment was installed in the new Postgraduate Surgical Skills Laboratory and was earmarked for training in endoscopic surgery, which established the School as one of only two such training facilities in South Africa.

The equipment and facility have been used by MMed students and other practitioners in gynaecology, surgery, orthopaedics, urology, and cardio-thoracic surgery.

The first faculty teaching awards were held in 2014. Prof Jannie (JF) Hugo and his team received an award for their work in Community Oriented Primary Care (COPC) for which they won the 2013 Higher Education Learning and Teaching Association of Southern Africa (HELTASA) team award.

In 2015, the following people received awards: Prof Sumaiya (S) Adam (Obstetrics and Gynaecology), Prof Mandisa (M) Kakaza (Neurology), Dr Johan (J) Potgieter (Haematology) (School of Dentistry), Prof Corné (TC) Postma (School of Dentistry), Prof Carin (C) Maree (School of Health Care Sciences), Dr Astrid (AC) Turner (School of Health Systems and Public Health (SHSPH)). In 2016, Joji Theron (Anatomy) (young emerging category), Prof Vinesh (V) Bookhan (Dentistry) and Prof Karien (K) Mostert (Physiotherapy) received awards. Prof Rhena (R) Delpont (skills lab) was the winner in 2017 and in 2018, Dr Karl-Heinz (K-H) Merbold from Dentistry received an award.

The SoM continued to follow a strong school model, and was largely autonomous in terms of the curriculum that was offered. The curriculum followed in the MBChB programme was, and continues to be, discussed during bi-annual block chairs meetings.

The School was also home to the Centre of Ethics and Philosophy of Health Sciences (CEPHS), headed by Prof Werdie (CW) van Staden. The CEPHS provides a synergistic platform for research into ethics for both associates and students that is responsive to South African and international trends as well as regulatory requirements.

## DEPARTMENTS

### 1. Anaesthesiology

Established as the first independent academic Anaesthesiology department in 1959, the Department had grown to include four training hospitals on a rotation basis by 2018. The activities of the Department consisted of service delivery at four circuit hospitals, clinical training, academic teaching, and research. In addition to the Steve Biko Academic Hospital, registrars were also trained at other circuit hospitals, namely Kalafong Hospital, 1 Military Hospital, and Witbank Hospital.

Prof Arthur (JLA) Rantloane was the Head of Department from 2009 to 2018.

At the mid-point of the review period, the Department had 23 registrars. The Department grew to include 48 registrars and



22 dedicated full-time consultants based at the four hospitals. Twelve medical officers, studying towards the Diploma in Anaesthesia and primary subjects, were at the two main teaching hospitals helping with service delivery.

The Department of Anaesthesiology continued to build on its research offering. In 2010, Dr Francois (FJ) Smith and Dr Sandra (S) Spijkerman, and co-authors, investigated the effects exerted by various concentrations of nitrous oxide on the spectral entropy of the electroencephalogram. In 2012, Dr Smith and co-authors described the effect of positive end-expiratory pressure on pulse pressure variation in the *South African Journal of Anaesthesia and Analgesia* (SAJAA). In 2017, Dr Spijkerman reviewed the physiology of one lung ventilation to guide the use of video-assisted thoracoscopic surgery in children. The article was also published in the SAJAA.

Anaesthetists in the Department also collaborated with other researchers in the School of Medicine. For example, in 2017, Dr Andrie (A) Alberts (Clinical Head: Department of Anaesthesiology and Critical Care, Kalafong Provincial Tertiary Hospital) worked with colleagues in the Department of Obstetrics and Gynaecology at Kalafong Provincial Hospital to validate maternal cardiac output assessed by transthoracic echocardiography in severely ill pregnant women.

Colleagues from the Department of Anaesthesiology were also active contributors to the South African Society of Anaesthesiologists (SASA) Guidelines. In 2012, Dr Hyla (H) Kluys contributed to the SASA Practice Guidelines, and in 2014, Dr Alberts contributed to the SASA Airway Guidelines.

These achievements and contributions further raised the Department's profile in this specialised field. Difficult airway management was developed as a specialised field of expertise, resulting in the Department contributing nationally recognised experts.

### 2. Anatomical Pathology

The Department of Anatomical Pathology was headed by Dr Melanie (M) Louw from 2008 to 2013, with the post being vacant in 2014. Over 2015 and 2016, Dr Cinzia (C) Campaini filled in as Acting Head until the appointment of Prof Meshack (NM) Bida in 2017.

The Department of Anatomical Pathology was one of six academic departments with close ties to the National Health Laboratory Service (NHLS), the other five being Chemical Pathology, Haematology, Immunology, Medical Microbiology and Medical Virology. On 1 October 2001, the Department of



Anatomical Pathology became part of, and was administered by, the NHLS. The Department was actively involved in the cytopathology screening programme of the Department of Health and rendered a service to the Tshwane Metropolitan Clinics as well as clinics in other provinces. The Head of Department was the chief cremation referee of the Tshwane Metro and the senior pathologists in the Department also acted as cremation referees.

The Department played a pivotal role in the training of medical and dental students, contributing to most of the MBChB blocks from the second to the final years of study.

Students in the allied sciences also completed a semester course in Anatomical Pathology. Postgraduate training in Anatomical Pathology was offered for the MMed (Path) degree for registrars as well as training for the pathology component of the courses in MChD Oral Pathology and MMed Forensic Pathology. The Department was also responsible for pathology teaching in all other MMed disciplines with pathology as a required subject for the MMed degree. Throughout the review period, the Department accommodated approximately 10 registrars in training, with two to three registrars completing their training every year.

The Department rendered a diagnostic histopathology and cytopathology service to the Steve Biko Academic Hospital, the Kalafong Hospital, all the Mpumalanga state hospitals and clinics as well as those in east and west Limpopo province and parts of the North West province. The Department received approximately 19 000 surgical pathology specimens and 30 000 cytology specimens annually.

During the review period, the Department regained accreditation after operating without a full-time head of department for a period of about five years. Staff morale deteriorated during this period and some consultants left. This placed additional strain on the remaining staff members, who had to carry a higher service load. Due to this staff shortage, the postgraduate academic training programme also became challenging to run, and registrar training was reduced to the bare minimum.

The research in the Department focused on a wide range of pathological topics, and was cross-disciplinary in nature. Researchers in the Department collaborated with Prof Greta (G) Dryer on human papillomavirus, and Prof Thomas (TT) Slavik, who joined Ampath in this period, and continued to work with the Department as an extraordinary professor.

The Department hosted a Gastroenterology workshop in 2013 and hosted biennial Bushpath workshops in collaboration with Ampath throughout the period under review.

### 3. Anatomy

The Department of Anatomy was headed by Prof Jan (JH) Meiring from 2008 to 2010. Prof Meiring left the Department to assume the role of managing director of Bestmed, a prominent medical insurance company. Prof Marius (MC) Bosman served as Head of Department from 2011 to 2018, and beyond.

Owing to the extent of the field of anatomy, the Department of Anatomy was divided into three units, namely:

- Clinical Anatomy — Head: Prof Albert (AN) van Schoor
- Cell Biology and Histology — Head: Prof Megan (MJ) Bester
- Physical Anthropology — Head: Prof Erika (EN) L'Abbe.

The research conducted in the Department generally fell into one of these three topics. The Department of Anatomy continued to be a research-intensive department within the School of Medicine and Faculty of Health Sciences. In 2016, the bone collection was moved to a new venue on the Prinshof Campus.

The Department worked with more than 6 000 students per year and was involved in more than 90 undergraduate and postgraduate modules.

In addition to being involved in the training of health professionals, the Department has had a postgraduate programme with specialisation in Clinical Anatomy, Cell Biology/Histology and Skeletal Biology/Physical Anthropology. Successful candidates can obtain a BSc (Hons), MSc, and PhD in any of these three main research focus areas.

The Department was also involved with the Faculty of Natural and Agricultural Sciences, especially in the BSc MedSci, a programme aimed at training students in the basic medical sciences, with the objective of research, laboratory work or academia. The three-year degree provides a broad background in medical sciences, and students are strongly advised to continue their studies to include at least an honours degree, in order to establish themselves in a particular field, including anatomy, physiology, pharmacology, and chemical pathology.

There were several achievements and highlights in the Department of Anatomy:

In 2016, Natalie (N) Keough was identified by the Tuks Young Research Leader Programme (TYRLP) to become a TYRLP fellow. The TYRLP programme, run by the Future Africa Institute, is aimed at developing early career academics at UP in the areas of thought leadership, team development, engagement and collaboration, thereby enabling them to recognise, approach and solve complex societal issues. The programme aims to build a community of like-minded young researchers who possess qualities that would contribute to UP becoming a research-intensive university. Other notable TYRLP fellows were Prof Albert (AN) van Schoor (2015), Dr June (JC) Serem (2017), and Dr Helena (H) Taute (2018).

In 2018, Prof Marius (MC) Bosman received a distinguished member award from the Anatomical Society of South Africa (ASSA). He joined ASSA in 1979 as an undergraduate student, and has played an integral role in promoting academic excellence among South African anatomists.

Prof Van Schoor was a founding member of the Global Community of Anatomical Science Educators (GCASE) which evolved out of a Scholarly Interest Group for Anatomical Sciences (ASSIG). He also co-authored both the 7th and 8th editions of the Abrahams and McMinn's *Clinical Atlas of Human Anatomy*, published in 2013 and 2019, respectively. Prof Van Schoor received an invitation to co-organise and attend the 3rd Hanno Boon Dissection Masterclass. The Masterclass was hosted by the Department of Anatomical Sciences, St George's University in Grenada, West Indies from 5 to 13 December 2016.

The 5th Cochlear Implant and Advanced Temporal Bone Dissection course was presented in the Department from 11 to 13 October 2016. About 125 delegates attended the course. Various workshops were presented during the course, which included a Southern ENT/CochlearTM NucleusR Surgical Masterclass, a Southern ENT/CochlearTM BahaR Surgical

#### Forensic Anthropology Research Centre

The Forensic Anthropology Research Centre (FARC) at UP was established in the Department of Anatomy in 2008. Prof Maryna (M) Steyn served as the first Director of FARC. In 2015, Prof Erika L'Abbé succeeded Prof Steyn as the second Director of FARC. Research in the Centre has focused on human variation in modern populations, particularly South Africans, for applications in orthodontics and medico-legal investigations, namely facial approximations, presumptive identifications, patterns of decomposition, and interpreting traumatic injury to bone. FARC researchers were also interested in the evolutionary history of South African fossil hominins as well as education in biological anthropology and expertise development in the discipline of Forensic Anthropology. Through Erasmus+ co-funded grant projects, FARC was a leading research and innovation entity in micro-CT and 3D printing of human skeletal material in southern Africa through collaboration with local and international partners. The Centre hosted numerous workshops, including a five-day workshop on the interpreting of skeletal trauma, presented by Prof Steven (SA) Symes, who is an extraordinary professor in the Department of Anatomy. Prof Symes (Mercyhurst University, US) is a world expert in the interpretation of bone trauma and has a particular specialty in criminal dismemberment and mutilation. A clinical anatomy maceration workshop, attended by 22 individuals from across South Africa focused on the process that goes into the maceration of human remains.

Masterclass, the Pretoria Nerve Facial Course, and a Temporal Bone Dissection Course. The course was very well attended by national delegates and international guests from the fields of otorhinolaryngology and audiology to name a few. The practical sessions were presented with the aid of the latest state-of-the-art surgical equipment and microscopes supplied by industry.

## 4. Chemical Pathology

Prof Nikki (NM) Oosthuizen served as Acting Head of Department from 2008 to 2012, and was succeeded by Prof Tahir (TS) Pillay who also served as Acting Head of Department for the rest of the period under review (2013–2018). Prof Pillay was appointed Editor-in-Chief of the *Journal of Clinical*

*Pathology* from January 2017. In the same year, Prof Pillay gave the keynote address at the International Cell Signalling Conference, held from 25 to 26 July at the Terengganu University (Malaysia).

The diagnostic laboratory service fell under the ambit of the National Health Laboratory Service (NHLS). The Department of Chemical Pathology provided diagnostic pathology services to the Steve Biko Academic (SBAH), Tshwane District and Weskoppies hospitals and 60 clinics in the Pretoria region. In addition to providing after-hour laboratory services to Pretoria West and Mamelodi hospitals, referrals were received from private and NHLS laboratories nationwide.

During the review period there were a number of major events, which all impacted significantly on daily operations.

### Clinical Unit Critical Care

The Clinical Unit Critical Care comprises a relatively young but rapidly evolving unit within the Faculty of Health Sciences that was established to consolidate diverse critical care units across various departments. The Clinical Unit Critical Care emerged from the recognition that health care providers with specialised skills are required to care for seriously ill patients. Initially known as the Department of Critical Care, the unit underwent a name change in 2015, and became known as the Clinical Unit Critical Care.

Prof Jan (JP) Pretorius served as the Head of the Clinical Unit Critical Care until the end of 2015 when he was succeeded by Prof Fathima (F) Paruk. The Heads of the Unit worked closely with the departments who fall within the ambit of the Unit.

The need for closer cooperation between standalone units became clearer with time, and paved the way for an interdisciplinary division and — ultimately — a Department of Critical Care. Dr André (A) van der Walt, Prof Jan (JP) Pretorius, Dr Greg (GR) Tintinger and Prof Henry (HP) Shapiro met regularly to discuss models to facilitate this transition, which was taken up by the hospital management during the last quarter of 2009.

Dr Ernest (E) Kenoshi, CEO of the Steve Biko Academic Hospital (SBAH), obtained permission to appoint Prof Pretorius as the first Head of the Unit of Critical Care at SBAH at the rank of principal specialist. This helped to continue the unification of critical care at SBAH in the interest of excellent patient care, support education in critical care for nursing staff, medical officers and registrars, and train critical care subspecialists. By 2009, excellent equipment had become available, which contributed largely to intensive monitoring and treatment. In addition to the departmental consultants and rotating registrars, five medical officers were appointed in a full-time capacity in critical care. Aligned to specialist training, postgraduate students from surgical and medical disciplines rotated through the critical care units and participated in the intermediary course, which covered the principles of acute patient care. Additionally, registrars from Anaesthesiology, Otorhinolaryngology and Maxillo-facial Surgery benefited by rotating through the various critical care units as well. The consultants heading the units, Prof Pretorius, Prof Herman (HJC) du Plessis, Dr Tintinger, Dr Wilma (TW) de Witt, Dr Susan (SD) Delport and Prof Shapiro were promoted to adjunct professors. There was a renewed interest from newly qualified specialists to enrol in subspecialty training with four training posts being accredited by the HPCSA.

The Clinical Unit facilities comprised five Adult, one Paediatric and one Neonatal Intensive Care units, as well as three High Care units. The units were staffed by a team of skilled, innovative, collaborative and caring medical, nursing, clinical technologists, and allied health professionals, as well as clinical technologists, who took care of complex critically ill patients. The units also had an active nursing leadership group and a clinical nurse specialist who provided mentorship and coaching to new and experienced staff.

Units were actively involved in teaching of under- and postgraduate medical students and also offered a Fellowship Programme in Critical Care for specialists from various disciplines.

The first of these was the implementation of electronic gatekeeping (EGK) by SBAH in May 2012. A second major event was replacing the existing DISA laboratory information system (LIS) with TrakCare in October 2012. The implementation was challenging for several reasons, not least of all that the Tshwane Academic Division was only the second academic site to go live since the start of the national roll-out. Increased test volumes, technical staff shortages, EGK and the new LIS all contributed towards the deterioration in turnaround times. Remote sign-out of test results by registrars after hours was just one of the measures introduced in 2012 to address turnaround time delays. Measures planned for the future would be the introduction of auto-verification on TrakCare and further automation of analytical processes.

In February 2016, the laboratory acquired new automated chemistry and immunochemistry instruments (Abbott Architect Ci8200) to replace the old Beckman instruments. These new analysers were integrated with LIS to assist in sample management and improved workflow and data management. A new benchtop HbA1c Variant II high-performance liquid chromatography (HPLC) instrument was also installed and was linked to the existing TrakCare LIS, which made a notable contribution towards optimising the turnaround times of HbA1c tests.

TrakCare auto-verification was implemented in July 2017, which helped further to improve turnaround times, and the Abbott auto management system (AMS) was to be implemented toward the end of the review period. The Department had experienced challenges in meeting turnaround times, due to limited staff capacity and staff shortages. Very few medical technologists were trained on these specialised tests. Vacant posts were only filled in February 2018, which enabled the training of more staff on specialised benches.

The laboratory performed approximately 1 million tests per year and had retained its status as a SANAS (South African National Accreditation System)-accredited laboratory since 2003. By 2018, the Department was conducting more than 2 million tests per year, resulting in a net profit of more than R83 million.

Following a period of staff attrition brought about by the incorporation with the NHLS, the Department of Chemical Pathology regained its research momentum with the appointment of Prof Pillay as permanent Head of Department in 2013, and the appointment of new pathologists — Dr Rivak (R) Punchoo, Dr Lizelle (L) Nagel and Dr Chantel (C) van Niekerk. Also, Dr Mahjoub (MYA) Ismail completed a

postdoctoral fellowship and contributed significantly to the research productivity of the Department.

In 2018, the Department held a novel academic boot-camp to support final-year medical students preparing for their final examination. The boot-camp complemented traditional lectures received during the block. Using a short student questionnaire coupled with a test item analysis of prior student class test performance, lecturers identified conceptual problem areas. These problem areas were formulated into clinical cases and presented at the boot-camp. This format developed higher cognitive learning and encouraged students to interact in small groups aimed at resolving common conceptual problems in chemical pathology. Dr Punchoo, chair of the block, said that future boot-camps would incorporate hybridised learning methodologies to strengthen contemporary evidence-based pedagogic practices. In addition, he noted that the boot-camp method led to closer registrar involvement in Chemical Pathology as registrars were invited to participate in the undergraduate medical curriculum.

## 5. Dermatology

The Department of Dermatology had three different heads of department in this review period. In 2008 and 2009, Prof Witold (WK) Jacyk served as Acting Head of the Department. He was followed by Dr John (MJ) Moche, who served as Head of the Department in 2010 and 2011. Dr Moche was tragically shot and killed in a highjacking in 2012, at the age of 41. The Head of Department post remained vacant in 2012 and 2013, until the appointment of Dr Mahlatse (CM) Kgokolo as Head of the Department from 2014 to 2018.

The Department of Dermatology remained focused on postgraduate teaching, with the main offering being an MMed in Dermatology.

The Department is a relatively small department with three full-time specialists employed at the Steve Biko Academic Hospital, and one full-time specialist employed at the Kalafong and 1 Military hospitals, respectively. A similar number of registrars were appointed at each health care facility. The clinical services provided to patients remained the main strength of the Department. Patients were referred largely from the Tshwane area and Mpumalanga province. The Department also successfully launched the Gauteng Branch of the Vitiligo Society of South Africa in 2009.

The Department retained its accreditation from the Health Professions Council of South Africa throughout the period

under review. It remained committed to rendering an excellent clinical service to its patients, and to providing appropriate and excellent training to undergraduate students, in addition to its focus on the MMed in Dermatology.

## 6. Family Medicine

Prof Jannie (JFM) Hugo served as Head of the Department of Family Medicine for the entire period under review, from 2009 to 2018 and beyond.

The Department of Family Medicine continued to take a holistic, bio-psycho-social approach to health. Family Medicine is critical to the integration of health care in the District Health System. The UP Department of Family Medicine was involved in patient care, teaching and research in Tshwane, Ekurhuleni, Mpumalanga, and other provinces. The Department practised coordinated care from a community oriented primary care (COPC) approach, following the motto, 'high touch-high tech', meaning that the approach is patient-centred while increasingly using information and communications technology to develop ways of implementing universal health care.

The Department of Family Medicine had many partners during this period, including Public Health Medicine, other practitioners in health care, other related disciplines, the Department of Health (DoH), and private and not-for-profit organisations.

Two qualifications offered are briefly described. The first is the National Certificate (Vocational) Primary Health qualification:

In 2011, the DoH, the Department of Higher Education and Training (DHET) and the Health and Welfare Sector Education and Training Authority (HWSETA) developed a National Certificate (Vocational) (NC(V)), programme in Primary Health as an Umalusi-approved full-time three-year certified qualification at levels 2, 3, and 4 on the National Qualifications Framework (NQF). The programme comprised four vocational subjects — the South African health care system, public health, human body and mind, and COPC — and the three compulsory subjects for all vocational qualifications.

Prof Tessa (TS) Marcus in the Department of Family Medicine was instrumental in guiding the curriculum outcomes and compiled learning material for all three levels for the subject COPC, and authored the learning material for all three levels. The first NC(V) Primary Health cohort of 1 200 full-time

students were enrolled in 2013 at 12 Technical and Vocational Education and Training (TVET) Colleges on 14 campuses across the country. Prof Marcus and the Family Medicine Department presented a training programme for TVET college lecturers from all 12 colleges to support the implementation of the curriculum. These workshops were run twice a year, for three years, from 2013 to 2015, and were designed to orient and prepare programme lecturers for each level of the qualification as it came on stream, and to provide follow-up and assessment support.

The Department of Family Medicine entered into a partnership with the City of Tshwane (CoT) and the Gert Sibande TVET College in Mpumalanga to present the NC(V) Primary Health curriculum on a part-time basis over four years to existing community health workers (CHWs) employed by the CoT, as a work-integrated learning model. This programme had been running since April 2014.

Lecturers were appointed by the UP Family Medicine Department to teach the curriculum, and classes were held at the UP Mamelodi Campus. The first cohort completed the qualification at the end of 2017 (16 CHWs), and the second cohort was due to complete at the end of 2019. For several reasons unrelated to student performance, the levels of learning, and the potential value of graduates to primary health care re-engineering, the NC(V) Primary Health qualification was formally ended in 2016 by the DHET.

The second qualification offered by the Department was the BCMP (Bachelor of Clinical Medical Practice):

The Department of Family Medicine developed the BCMP bachelor's programme as part of a national initiative in response to the massive need for clinicians in primary health care in district health in South Africa. The Department of Family Medicine was responsible for the whole programme. The BCMP programme followed a decentralised training model in which the students from first to third and final year were dispersed into primary health care settings under the supervision of qualified nurses, clinical associates and medical officers within Gauteng, Mpumalanga, Limpopo and KwaZulu-Natal to gain exposure to common conditions patients present with, and to gain relevant knowledge, skills and competence in these contexts. Special emphasis was placed on the Standard Treatment Guidelines, and the Essential Medicines Lists applicable to primary care and district hospitals, as well as the Adult Primary Care Guidelines and Integrated Management of Childhood Illness (IMCI) Guidelines.

In addition to the above, there were several highlights in this period:

The Department of Family Medicine developed the first version of AitaHealth software in 2011, at which time about 54 community health workers were involved in the project. The first version of AitaHealth was based on individual assessments related to the most important burden of diseases, epidemics and maternal and child health. The project ended around 2013 when the CoT approached the Department to roll out a community oriented primary care project, which presented an opportunity to develop a second version of the software, building on what had been learned.

In 2014, the Daspoort Clinic commemorated its history — Daspoort-50 years of caring. The Daspoort Clinic started in 1964 as a UP student initiative to support the local community and to gain practical work experience. Medical students saw patients with the support and supervision of a medical doctor. Daspoort Clinic was essentially a clinic run by students for students and the community. Besides exemplifying UP as a university that engaged with its communities, the Clinic supported the multidisciplinary and interdisciplinary approach that saw a number of departments and schools using Daspoort Clinic for community-based service learning. The Clinic fell under the Department of Family Medicine, in the Faculty of Health Sciences, in cooperation with the Gauteng Department of Health.

In 2016, the City of Tshwane and the Department of Family Medicine (UP) developed the community-oriented substance use programme (COSUP) that uses a harm reduction approach to prevent and manage substance abuse, reduce and contain injecting drug-driven HIV and TB infection, and improve the quality of life of individuals and families affected by substance abuse. The COSUP collaboration worked in partnership with a range of government and university departments and third-sector organisations, including the Gauteng Department of Health, the UP Department of Social Work and Criminology, the Tshwane Leadership Forum and more. By the end of the period under review, COSUP was operating at 17 sites across Tshwane. The COSUP programme continuously provided counselling, linkage to care and opioid substitution therapy services to 1513 adults (median age of 30 years), most of whom are male (90%), with similar proportions of clients who smoke (51%) or inject (49%) heroin. The service is ongoing.

In 2018, Prof Jannie Hugo was awarded the lifetime achievement award from the South African Medical Association (SAMA) for outstanding, pioneering contributions to the primary health care system.

## 7. Forensic Medicine

Prof Gert (GG) Saayman served as Head of Department of Forensic Medicine from 2007 to 2018, and beyond. Prof Saayman was the fifth head since the establishment of the Department in 1946. Forensic Medicine was part of the School of Medicine, housed in the Pathology Building, adjacent to the Steve Biko Academic Hospital. The Department had 15 full-time and part-time academic faculty and support staff.

The Department of Forensic Medicine presented approximately 70 lectures and tutorials to undergraduate medical students, in their second, third, fourth and fifth years of study. In their fifth year, students attended daily medico-legal autopsy sessions for a period of two weeks at the Pretoria Medico-Legal Laboratory.

The academic offering included the MMed (Path)(Forens) degree. This postgraduate degree trained previously qualified medical practitioners and those who held a joint appointment with the Gauteng Provincial Department of Health and the University of Pretoria as medical registrars/residents. The MMed degree comprised a four-year residency programme. The programme included extensive theoretical and practical training in the fields of pharmacology/toxicology, physiology, anatomy, molecular pathology, forensic and anatomical pathology, and research methodology. Specialists in forensic pathology can register as a specialist forensic pathologist with the Health Professions Council of South Africa (HPCSA).

BSc (Hons) and MSc in Medical Criminalistics degrees were offered to students who had completed an undergraduate BSc degree in biomedical sciences, with appropriate preparatory subjects. These students had an opportunity to interact and participate in the full scope of medico-legal investigation of death, including attendance at death or crime scenes, visiting police and other forensic laboratories (such as chemistry, toxicology, odontology and anthropology laboratories).

Some of the highlights in this review period included the following:

In 2016, Neil (NK) Morris was nominated as a Tuks Young Research Leader Programme (TYRLP) fellow. The TYRLP programme aims to develop early career academics at UP in the areas of thought leadership, team development, engagement and collaboration, enabling them to recognise, approach and solve complex societal issues. In 2018, Mr Morris was seconded to the International Committee of the Red Cross (ICRC), Pretoria delegation.

In 2016, Dr Ryan (R) Blumenthal was nominated as a finalist in the National Science and Technology Forum (NSTF) Awards which recognise outstanding contributions to science, engineering and technology (SET) and innovation for researchers and other SET related professionals.

## 8. Haematology

Prof Roger (R) Pool was Head of the Department of Haematology for the period 2009 to 2018, and beyond.

The Department of Haematology rendered tertiary diagnostic as well as clinical services to the Steve Biko Academic Hospital (SBAH), Tshwane District Hospital, Kalafong Hospital, and surrounding clinics. The Department of Haematology comprised a core laboratory, specialised coagulation unit, bone marrow unit, flow cytometry unit, and a research department. Clinical services were organised under the umbrella of the Department of Internal Medicine and Paediatrics while diagnostic services fell within the ambit of the Tshwane Academic Division of the National Health Laboratory Service (NHLS).

The academic department was located in the Institute of Pathology, Prinshof Campus, and housed the offices of the pathologists, registrars, scientists, and laboratory manager. Routine laboratory work included the review of peripheral blood films and bone marrow aspirates, platelet aggregometry, haemoglobin electrophoresis and specialised haematology.

The main laboratory was in Steve Biko Academic Hospital and tests done there included full blood counts with differential counts and examination of peripheral blood films, erythrocyte sedimentation rates, and coagulation profiles. The bulk of the diagnostic work was performed in the core laboratory. Tests that had a short turnaround time with a direct impact on patient management were performed there. To give a sense of scope, the core laboratory processed 356 496 and 403 838 tests in 2015/2016 and 2017/2018, respectively.

The Department trains registrars in Haematology (six per year) and in Clinical Pathology (five per year), with the number remaining constant for this period. The number of staff grew to 32 members by 2018. The staff complement includes pathologists, medical doctors, scientists, technologists and support staff. In 2015, the Department of Haematology received two additional posts for registrars, bringing the number of approved posts to eight.

The Department also ran an Adult Haematology Clinic that provided a consultation service to both the SBAH and the wider community of Pretoria. The Clinic served as an important vehicle for the teaching of undergraduate medical students as well as haematology and internal medicine registrars.

At the University of Pretoria, Haematology was taught as a clinical subject at the undergraduate level and as a laboratory subject to postgraduates. The Department participated in one teaching block (Block 280) and two special activities (SA 12 and SA 13). Undergraduates learned how to work up, diagnose and treat patients with haematological disease and how to request and interpret laboratory tests. They also learned about haematological malignancies (which make up 9% of all cancers) as well as the principles and practice of blood transfusion.

At the postgraduate level, registrars were taught how to diagnose haematological disease using a number of modalities (morphology, cytochemistry, immunophenotyping, cytogenetics and molecular genetics). About twenty percent of the curriculum was devoted to clinical work, which involved the management of patients with haematological disease. Training took place over a four-year period after which the student was entitled to register with the Health Professions Council of South Africa (HPCSA) as a specialist pathologist.

Research interests in the Department included haemophilia comprehensive care, neutrophil extracellular traps, micro-RNA in chronic myeloid leukaemia, plasmablastic lymphoma, platelet activation, AML profiling using micro-array platforms and minimal residual disease detection by flow cytometry in childhood leukaemia. The Department established a South African Haemophilia registry, to monitor all haemophilia in the country with records on their treatment, hospital visits, surgery, and other interventions. The project aimed to link haemophilia care across South Africa to allow for seamless follow-up.

## 9. Immunology

The Department of Immunology saw three different Heads of Department in this period. Prof Ronnie (R) Anderson, served in this leadership position from 2008 to 2011. Following his retirement in June 2012, he was succeeded by Prof Riana (R) Cockeran who served as Acting Head in 2012, and was formally appointed as Head of Department from 2013 to 2016. Prof Pieter (PWA) Meyer took up the position as Acting Head of Department in 2017 and 2018.

The Department of Immunology continued to be a strong research and academic driven department, involving both undergraduate and postgraduate students. It distinguished itself as an excellent research facility, hosting researchers with high scientific standing and participating in local, national and international collaborations, which strengthened its research, teaching and training abilities. The Department also accommodated several research clusters and a diverse range of research modalities.

There were a number of major services commitments, which included the provision of serodiagnostic (auto-immune, allergic, infectious diseases), complementology, flow cytometric (leukaemia immunophenotyping, detection and monitoring of primary and secondary immunodeficiency diseases), and tissue typing procedures (HLA typing and HLA antibody detection).

The Department also fell under the ambit of the National Health Laboratory Service (NHLS), and analysed in excess of 6 000 tests on a monthly basis, with the test volume exceeding 320 000 tests by the end of 2018. It employed staff members and trainees, including postgraduate students. There was a reduction in the number of staff members by the end of 2018, with only 10 qualified staff members remaining in the Department; the number of trainees also decreased to 16.

The Department of Immunology formed the foundation for several research units. Prof Anderson headed up the South African Medical Research Council (SAMRC) Unit for Inflammation and Immunity, which was established in 1989 and ended in 2014. Prof Michael (MS) Pepper also established the Institute for Cellular and Molecular Medicine (ICMM) in 2008, and Prof Robert (RP) Millar established the Centre for Neuro-Endocrinology in this period.

Some of the highlights are briefly described:

The Department of Immunology initiated the HIV-1 Mucosal Pathogenesis and Treatment Programme to serve as a platform for highly collaborative research. Two projects, a drug resistance study, and an HIV-1 enteropathy study, had garnered approximately R16 million in funding from the European Union and the National Research Foundation.

In 2014, Prof Pepper and the ICMM were awarded the SAMRC Extramural Research Unit for Stem Cell Research and Therapy. SAMRC status is given to a host institution with a well-qualified and productive research team — including well-established scientists, early career scientists and postgraduate students — with access to the necessary infrastructure already in place.

In 2017, Prof Millar was awarded the prestigious Harry Oppenheimer Fellowship for his work in neuro-endocrinology. The Oppenheimer Fellowship is awarded to researchers and academics who show a strong track record of groundbreaking research and intellectual achievement. It is regarded as one of the top awards for research on the African continent.

In 2018, the Department of Immunology introduced neuronal associated autoantibody screening to accommodate amplified requests from Steve Biko Academic Hospital.

In 2018, Prof Annette (AJ) Theron retired from the NHLS/ Department of Immunology after 35 years of service. Prof Theron published more than 104 peer-reviewed articles during her successful academic career.

## 10. Internal Medicine

### Steve Biko Academic Hospital

The Department of Internal Medicine, located at the Steve Biko Academic Hospital (SBAH), had three Heads of Department in this period. Prof Antoine (AL) van Gelder was Head of Department for the period 2008 to 2010, followed by Prof James (JA) Ker in an acting capacity for the years 2011 and 2012. Prof Greg (GR) Tintinger was appointed in 2013 as the new Head of Internal Medicine.

The Department rendered tertiary services to patients from the greater Tshwane region. It had a full component of subspecialist units, of which Cardiology was functioning as a totally separate department.

The Department of Internal Medicine at SBAH utilised 77 hospital beds and had a 10-bed medical ICU in this period. The renal unit comprised a 14-bed nephrology ward and a dialysis unit, which delivered chronic renal replacement treatment to 18 patients.

The Department also provided outpatient services in the form of General Internal Medicine outpatient clinics as well as specialist clinics. The scope of services was, on average, 9 800 patients at SBAH, and 24 700 outpatients per year.

### Kalafong Hospital

The Head of Department of Internal Medicine at Kalafong Hospital was Prof Johan (JH) Retief. The Department of Internal Medicine rendered services to patients from the



western and southern greater Tshwane area. It utilised 180 out of the available 850 hospital beds, and shared a high care unit and ICU (14 and 8 beds, respectively) with other departments.

On average, more than 20 000 patients are seen per year at the General Medical Outpatient Department, as well as Specialised Diabetes and Rheumatology Units, which catered for an additional 1 000 and 600 patients, respectively. More than 6 000 patients per year are admitted to medical wards, mostly via the Emergency Unit. Supportive consultative services are offered to all other departments, including a shared service to pregnant diabetes patients, support and training at the Immunology Clinic by a consultant and rotating interns.

Staff of the Department were involved in ten undergraduate training blocks in the MBChB IV programme, with Dr Salome (S) Bothma as the coordinator of this programme at Kalafong Hospital.

## 11. Medical Microbiology

The Department of Medical Microbiology in the Faculty of Health Sciences is responsible for the teaching of Medical Microbiology to undergraduate and postgraduate students, as well as research and diagnostic services related to infectious diseases. The Medical Microbiology Laboratory served as an enhanced surveillance site for the National Institute of Communicable Diseases (NICD) and actively participated in the GERMS SA Surveillance programmes for enteric pathogens, mycology, parasitology, and respiratory and meningeal pathogens.

In 2009, the Department was headed by Prof Anwar (AA) Hoosen, who had been in the position since 2007. During his tenure, the Department focused on strengthening its research capacity in the areas of antimicrobial resistance and emerging infectious diseases. The Department also continued to provide diagnostic services to patients with infectious diseases through its clinical laboratory at the Steve Biko Academic Hospital.

In 2012, the Department expanded its diagnostic services with the rollout of the GeneXpert automated diagnostic test that could identify *Mycobacterium tuberculosis* (MTB) and resistance to rifampicin. The TrakCare laboratory information system was also implemented in 2012. Year-on-year, the Department continued to expand its diagnostic capabilities and steadily increased the number of tests being performed.

In 2013, the Department underwent a change in leadership, with Prof Nontombi (NM) Mbelle taking over as Head of Department. Under her leadership, the Department continued to focus on research, with a particular emphasis on antimicrobial resistance, HIV/AIDS, and tuberculosis. Throughout this period, the Department of Medical Microbiology remained committed to providing excellent medical education to its students, with a particular emphasis on clinical training.

The Department of Medical Microbiology underwent significant changes and expansion in its research capacity from 2009 to 2018. New research units and centres were established that focused on antimicrobial resistance, opportunistic infections, malaria, genomics, and neglected infectious diseases.

Some of the highlights in this period included the following:

- Prof Marthie (MM) Ehlers and Prof Bernard (B) Fourie received NRF C2 ratings, respectively in 2012 and 2014. Prof Ehlers was promoted to full professor in 2014.
- In 2018, Prof Fourie (extraordinary professor), was a finalist in the National Science and Technology Forum (NSTF) lifetime achievement awards category.

## 12. Medical Oncology

The Department of Medical Oncology in the Faculty of Health Sciences is responsible for the teaching of Medical Oncology to postgraduate students, as well as conducting research and providing clinical services related to cancer care. In 2009, the Department was headed by Prof Lydia (LM) Dreosti, who had been in the position since 2006. During her tenure, which was until 2017, the Department focused on strengthening its research capacity in the areas of epidemiology, oncology and clinical trials.

The Department also continued to provide high-quality cancer care to patients through its clinical services at the Steve Biko Academic Hospital and the Pretoria Cancer Centre. The post of Head of Department remained vacant for 2018 and 2019.

In 2010, the Department became an affiliate member of the Eastern Cooperative Oncology Group (ECOG). This affiliation was a first for South Africa and Africa at the time. The ECOG is a large network of international researchers, physicians, and health care professionals. The mandate of the ECOG is to work towards the common goal of controlling, effectively treating, and ultimately curing cancer. At the time the ECOG had more than 90 active clinical trials in all types of adult malignancies with an annual accrual of 6 000 patients with more than 20 000 patients in follow-up treatment.

In summary, the Department of Medical Oncology underwent significant changes and expansion in its research and clinical capacity from 2009 to 2018. The Department established new research units and centres focused on cancer epidemiology, cancer genetics and genomics, cancer prevention and early detection, and precision oncology. The Department remained committed to providing high-quality medical education and cancer care to its students and patients.

## 13. Medical Virology

The Department of Medical Virology is responsible for teaching Medical Virology to undergraduate and postgraduate students, as well as conducting research and providing diagnostic and clinical services related to viral infections. The Department fell within the ambit of the National Health Laboratory Service (NHLS). Through its association with the NHLS, the Department had biosafety level 4 capabilities, the only one in Africa.

In 2009, the Department was headed by Prof Lynne (LM) Webber, who had been in the position since the beginning

of the year. Prof Webber remained in this position until 2017 when Prof Maureen (MB) Taylor assumed the role as Acting Head until the end of the period under review. During Prof Webber's tenure, the Department focused on strengthening its research capacity in the areas of bloodborne viruses including the clinical and epidemiological aspects of HIV, hepatitis B and C viruses. Throughout this period, the Department of Medical Virology at the University of Pretoria remained committed to providing high-quality medical education to its students, with a particular emphasis on laboratory training.

The Department housed the human papillomavirus and cervical cancer research programme. Research in the Department also focused on enteric viruses with environmental origins, including viral zoonoses. In addition to the research and teaching, the Department continued to provide diagnostic services for viral infections to both the public and private sectors.

In 2014, the Department expanded its research capacity, with the establishment of the Centre for Viral Zoonoses (CVZ), initially known as the Zoonoses Research Unit. The CVZ research team has focused on the study of the zoonotic transmission of viral infections between animals and humans.

In summary, the Department of Medical Virology underwent significant changes and expansion in its research and clinical capacity from 2009 to 2018. The Department established new research units and centres focused on emerging viral infections, viral hemorrhagic fevers, viral zoonoses, and HIV/AIDS, in addition to providing high-quality medical education and diagnostic and clinical services to its students and patients.

Among the many highlights were the following:

In 2013, Prof Maureen Taylor was awarded a C2 rating from the NRF. She was also promoted to full professor and awarded the 'Rand Water Chair in Public Health'. Dr Janette (J) Mans was awarded a Y2 NRF rating in 2015 and received a merit award at the UP Academic Achievers' Awards function. In 2017, Dr S (Sim) Mayaphi was awarded an Exceptional Young Researchers Award, at the Academic Achievers' Awards function.

In 2013, the Diagnostic Virology Laboratory was nominated for the Best Academic Laboratory and was awarded the 'Best Performing Diagnostic Laboratory for Early Infant Diagnosis (EID HIV DNA PCR)' by Roche Diagnostics.



Prof Bernard Fourie (centre) and research team, MRC Clinical Research Unit for Tuberculosis

In 2015, Prof Marietjie (M) Venter was deployed to Congo Brazzaville as Centers for Disease Control and Prevention (CDC) liaison for the World Health Organization (WHO) Ebola Preparedness task force. In the same year, she was an invited speaker at the Informal Consultation on RSV using the Global Influenza Response Networks Surveillance (GIRNS), WHO (Switzerland). In 2017, Prof Venter served as an expert advisor on respiratory syncytial virus (RSV) in Washington DC (US).

In 2016, Prof Wanda (W) Markotter was awarded the DST-NRF SARChI Chair in Animal Infectious Diseases (Zoonoses). Prof Markotter had been involved in transdisciplinary research on bat species in South Africa and other African countries since 2005.

In 2017, Dr Mayaphi, Prof Taylor and Dr Mans served on the National Department of Health National Hepatitis Guideline and Diarrhoeal Disease working groups. In the same year, Prof Taylor was a finalist in the 2017 NSTF-South 32-Water Research Commission Award.

## 14. Neurology

The Department of Neurology in the Faculty of Health Sciences is responsible for teaching Neurology to undergraduate and postgraduate students, as well as conducting research and providing clinical services related to neurological disorders.

In 2009, the Department was headed by Prof Clara-Maria (C-M) Schutte, who held this position for the whole period under review. During her tenure, the Department focused on expanding its research capacity, with a particular emphasis on the study of neurological disorders such as stroke, epilepsy, and multiple sclerosis. The Department also continued to provide high-quality clinical services to patients with neurological disorders at the Steve Biko Academic Hospital and other affiliated hospitals.

Throughout this period, the Department of Neurology provided medical education to its students, with a particular emphasis on clinical training.

In summary, the Department underwent significant changes and expansion in its research and clinical capacity from 2009 to 2018. The Department established new research units and centres focused on stroke, multiple sclerosis, and neurogenetics. The Department also established a new clinical service, the Stroke Unit, and played a key role in the diagnosis and management of neurological disorders in South Africa.

## 15. Neurosurgery

The Department of Neurosurgery is one of the academic departments within the Faculty of Health Sciences. Its mission is to provide the highest standard of clinical care for patients with neurosurgical disorders, to train future neurosurgeons and researchers, and to conduct research that improves the understanding and treatment of neurosurgical disorders.

In 2009, the Department was led by Prof Sam (S) Mokgokong, who held the position of Head of Department until 2017. The post remained vacant in 2018. Prof Mokgokong was the first black South African to qualify as a neurosurgeon in 1987. Prof Mokgokong headed the teams responsible for separation of three sets of craniopagus conjoined twins. He had trained and mentored more than 20 neurosurgeons and produced the youngest neurosurgeon in Africa in 2017.

During his tenure, the Department continued to provide excellent clinical services to patients with neurosurgical disorders at the Steve Biko Academic Hospital, as well as other affiliated hospitals. These services included cranial and spinal surgery, neuro-oncology, and paediatric neurosurgery. The Department also provided a comprehensive training programme for medical students, residents and fellows, with a particular emphasis on clinical training.

In 2018, the Department continued to expand its clinical and research activities. It provided cutting-edge clinical services, including minimally invasive spinal surgery, stereotactic radiosurgery, and endoscopic surgery. The Department also continued to conduct ground-breaking research in the field of neurosurgery, with a particular focus on the use of novel therapies such as gene therapy and stem cell therapy for neurosurgical disorders.

In conclusion, the Department of Neurosurgery at the University of Pretoria underwent significant expansion in its research and clinical activities from 2009 to 2018, while continuing to provide medical education to students and residents.

## 16. Nuclear Medicine

The Department of Nuclear Medicine is one of the academic departments in the Faculty of Health Sciences. Its mission is to provide the highest standard of clinical care for patients with nuclear medicine related disorders, to train future nuclear medicine professionals, and to conduct research that improves the understanding and treatment of such disorders.

In 2009, the Department was led by Prof Mike (MM) Sathekge. Prof Sathekge held this position throughout the period under review. During his tenure, the Department continued to provide excellent clinical services to patients with nuclear medicine related disorders at the Steve Biko Academic Hospital, as well as other affiliated hospitals. Such services included diagnostic imaging, therapy, and radioisotope production. Under his leadership, the Department expanded its research activities, particularly in the areas of radionuclide therapy and molecular imaging. The Department also provided a comprehensive training programme for medical students, residents and fellows, with a particular emphasis on clinical training.

Under Prof Sathekge's leadership, the Department contributed significantly to the capacity building and mentoring of several students and fellows. Prof Sathekge's research efforts in advancing molecular imaging and developing clinical applications contributed to clinical and physiological studies on the role of positron-emission tomography (PET) and computerised tomography (CT) scans on patients suffering from HIV/AIDS and tuberculosis (TB).

In conclusion, the Department of Nuclear Medicine underwent significant expansion in its research and clinical activities from 2009 to 2018. The Department established new research groups, imaging centres, and training programmes. It continued to provide clinical services to patients with nuclear medicine related disorders, particularly in the areas of cancer diagnosis and treatment, neuroimaging and radionuclide therapy.

Highlights included the following:

In 2010, the Department of Nuclear Medicine hosted the International Atomic Energy Agency (IAEA) Regional Training course on the role of nuclear medicine in endocrine disease and infection and inflammation. More than 20 participants attended the meeting.

Also in 2010, Marlene (M) van Ginkel, chief radiographer at the Department of Nuclear Medicine, was awarded a Performance Excellence Award by the Department. She served fastidiously

first under Prof Bern (BJ) Meyer and later Prof Sathekge, had worked in the unit since 1988 and was a stalwart in the Department.

In 2013, Prof Sathekge was appointed as the new President for the International Society for Radiolabelled Blood Elements (ISORBE). The ISORBE Congress was hosted by the Department of Nuclear Medicine, University of Pretoria. Also in 2013, Dr Mariza (M) Vorster won the first prize in the second International Medical Olympiad, which was held in Thessaloniki, Greece. In 2018, Dr Vorster was awarded an NRF Y rating and was promoted to associate professor.

In 2014, the Department hosted a workshop on Basic Nuclear Medicine facilitated by Prof John (JR) Buscombe (Cambridge University Hospital, UK). In 2015, Dr Kehinde (OK) Ololade, a second-year MMed student won the award for distinguished work at the IAEA conference held in Vienna (Austria).

In 2016, Prof Sathekge was elected as the President of the Colleges of Medicine, South Africa. In 2017, Prof Sathekge was admitted as a fellow of the Academy of Medicine, Singapore. In the same year, Dr Ismaheel (I) Lawal, Dr Thabo (T) Lengana, Dr Gill (TMG) Boshomane, and Dr Ololade qualified as Nuclear Medicine Physicians. A further achievement for the

Department was the SAMRC's approval of R10,5 million for a research project on radio-immunotherapy of HIV patients. The University of Pretoria and the Steve Biko Academic Hospital jointly won the bid to host the National Nuclear Medicine Facility (NUMeRI).

## 17. Obstetrics and Gynaecology

The mission of the Department of Obstetrics and Gynaecology is to provide clinical care to women with obstetric and gynaecological disorders, to train future obstetricians and gynaecologists, and to conduct research that improves the understanding and treatment of obstetric and gynaecological disorders.

In 2009, the Department was led by Prof Gerhard (BG) Lindeque until 2017. In 2018, the position of Acting Head of Department was filled by Prof Greta (G) Dreyer and Dr Shuaib (S) Kauchali. During Prof Lindeque's tenure, the Department rendered clinical services to women with obstetric and gynaecological disorders at the Steve Biko Academic Hospital, as well as other affiliated hospitals, such as Kalafong and Tembisa hospitals. The Department also provided a comprehensive training programme for medical

students, residents and fellows, with a particular emphasis on clinical training. Under the leadership of Prof Lindeque, the Department expanded its research activities, particularly in the areas of reproductive health and foetal medicine.

The Department housed the SAMRC Research Unit for Maternal, Foetal, Newborn and Child Health Care Strategies. In 2017, the Unit participated in the World Health Organization, Global Maternal Sepsis Study (GLOSS). Data were collected over seven days from 54 countries to estimate the global burden of sepsis, a major contributor to maternal morbidity. The Unit also continued to contribute to the National Committee for Confidential Enquiry in Maternal Deaths (NCCEMD), and the triennial 'Saving Mothers' reports were produced with the seventh report covering the period 2014 to 2017. These reports continue to be widely used to improve maternal health care throughout South Africa.

In addition to the work of the SAMRC Unit, several research themes were actively pursued and research expanded, particularly in the areas of reproductive health and foetal medicine. The Department also expanded its clinical services by establishing new subspecialty units. These included a Urogynaecology Unit, Gynaecological Oncology Unit, Maternal and Foetal Medicine, and the Reproductive and Endocrine Unit. This Clinic provided state-of-the-art fertility treatment options, including in vitro fertilisation (IVF) and intracytoplasmic sperm injection (ICSI), and cutting-edge clinical services, including prenatal care, gynaecological surgery, and fertility treatment. The Department also continued to conduct ground-breaking research in the field of obstetrics and gynaecology, with a particular focus on the prevention and treatment of cervical cancer and on foetal medicine.

The Department of Obstetrics and Gynaecology underwent significant expansion in its research and clinical activities from 2009 to 2018. The Department established new research groups, clinics and training programmes, and continued to provide excellent clinical services to women with obstetric and gynaecological disorders, particularly in the areas of high-risk pregnancies, gynaecological surgery, and fertility treatment. The Department provided medical education to its students and residents and continued to conduct research that improves the understanding and treatment of obstetric and gynaecological disorders.

Highlights of achievement included the following:

Preceding this review period, in 2008, The Essential Steps in Managing Obstetric Emergencies (ESMOE) was developed, aimed at training all maternity staff in South African contexts

to combat high rates of maternal deaths. In 2012, funding became available to take the training programme to scale, and the programme was introduced throughout South Africa by the National Department of Health.

In 2013, Prof Bob (RC) Pattison was awarded an Exceptional Achiever's Award from the University of Pretoria, and in 2016, the prestigious Havenga Prize for medicine by the *Suid-Afrikaanse Akademie vir Wetenskap en Kuns*.

A year later, in 2017, Prof Ute (UD) Feucht and her research team were awarded a prestigious CIPHER grant to study the impact of foetal exposure to antiretroviral medication. The research team included Prof Theresa (T) Rossouw, Prof Pattinson, Prof Ameena (A) Goga, Mphele (M) Mulaudzi, Felicia (F) Molokane, together with Canadian collaborators from Carleton University.

Also in 2017, Prof Dreyer was awarded the coveted AG Oettle Memorial Medal from the Cancer Association of South Africa (CANSa) for her outstanding contribution to cancer research, training and clinical work.

In 2018, Prof Priya (P) Soma-Pillay was elected to serve on the executive board of the International Federation of Gynaecology and Obstetrics (FIGO). Several senior members of the Department attended the FIGO conference in Rio de Janeiro, presenting on subjects including contraception (Dr Zozo (Z) Nene), oncology (Prof Dreyer) and clinical obstetrics (Prof Pattinson).

Four staff members obtained their PhD degrees, including Prof Sumaiya (S) Adam, Prof Soma-Pillay, Prof Zeelha (Z) Abdool, and Prof Leon (LC) Snyman.

## 18. Ophthalmology

The Department of Ophthalmology provides tertiary eye care services to patients with eye diseases, offers training for medical students, residents and fellows, and conducts research to improve the understanding and treatment of eye diseases.

In 2009, the Department was headed by Prof Polla (P) Roux until 2011. In 2011, Dr Ahmed (AAO) Asholi served as Acting Head for two years, until the appointment of Dr Prisilla (PMS) Makunyane as Head of the Department from 2013 to 2018, and beyond.

The Department continued to provide comprehensive eye care services to patients with a wide range of eye diseases. It also offered a four-year residency programme



Prof Sathekge and the Department of Nuclear Medicine team

Prof Bob Pattison with Registrars Drs Rabothata (left) and Minisi at Kalafong Hospital



in ophthalmology and a fellowship programme in various subspecialties of ophthalmology, including glaucoma, vitreoretinal diseases, and cornea and external diseases.

During the review period, the Department focused on expanding its research activities, with a particular emphasis on diabetic retinopathy and glaucoma. In 2010, the Department of Ophthalmology received a sizable grant from the Embassy of Japan to upgrade the Vision 2020 Eye Care Clinic at the Pretoria West Hospital. This funding was expanded in 2012 with a donation of R195 000 from the PPS Insurance company, which allowed for upgrading of the Clinic's capacity for examining outpatients suffering from cataracts so that recommendations for cataract removal could be made.

Throughout this period, the Department of Ophthalmology provided medical education to its students and residents, and conducted research that improved the understanding and treatment of eye diseases. The focus also remained on rendering clinical services to patients with a wide range of eye diseases, including diabetic retinopathy, glaucoma, and paediatric eye disorders.

The Department of Ophthalmology underwent significant expansion in its research and clinical activities from 2009 to 2018. It established new subspecialty clinics, research groups, and community-based eye care services. One of the highlights during this period was the celebration of the third World Glaucoma Week in 2009 when the Department conducted free eye examinations in partnership with Steve Biko Academic Hospital, Kalafong, Tshwane District, Pretoria West, and Bronkhorstspuit hospitals.

## 19. Orthopaedics

The Department of Orthopaedics at the University of Pretoria has a long and proud history of providing high-quality orthopaedic care and training to medical students and residents. The Department is affiliated with the Steve Biko Academic Hospital and the Kalafong Hospital, both of which are tertiary referral centres for orthopaedic care.

In 2009, the Department was headed by Prof Hans (JG) Myburgh, who had been at the helm for several years. During

this time, the Department had developed a reputation for excellence in patient care, research and education. The Department had a strong focus on trauma, joint replacement surgery, and sports medicine, and was actively involved in research and clinical trials.

Over the next few years, the Department continued to grow and evolve. In 2010, Prof Mthunzi (M) Ngcelwane took over as the Head of Department. During his tenure, the Department continued to focus on trauma, joint replacement surgery, and sports medicine. At the time, he was Vice President of the South African Orthopaedics Association (SAOA) and had been elected to take over as President in September of 2010. The Department also began to place greater emphasis on research, with a number of research projects and clinical trials being conducted.

During this period, the Department hosted several national and international conferences, including the SAOA Congress and the International Society for Hip Arthroscopy (ISHA) Congress. The Department also hosted several visiting professors and surgeons from around the world, who provided valuable insights and expertise to the Department's faculty and residents.

In 2017, the Department underwent another major restructuring to improve its academic offerings and clinical services. This included the establishment of a dedicated unit for paediatric orthopaedics and the expansion of the Department's sports medicine programme. A new fellowship programme was also launched in foot and ankle surgery, which is designed to provide advanced training in this specialised field. The Department of Orthopaedic Surgery was renamed to the Department of Orthopaedics. At the time, registrars had to rotate through the surgical departments of the affiliated hospitals: Prof Mtunzi (MV) Ngcelwane, Kalafong Hospital; Dr Silas (NS) Motsitsi, 1 Military Hospital; Prof Theo (TLB) le Roux, Tembisa Hospital; Dr Samuel (S) Malebo; and Dr Brian (BN) Mazabane, Witbank Hospital.

Throughout this period, the Department provided orthopaedic care to patients in the Pretoria area and beyond. Its faculty and residents also contributed to the wider community by providing educational programmes and outreach services to underserved communities.

The Department of Orthopaedics underwent significant growth and development from 2009 to 2018. It expanded its clinical services, research activities and academic offerings, while maintaining the provision of orthopaedic care and training to medical students and residents. The Department's

faculty and residents also made valuable contributions to the wider community through educational programmes and outreach services.

## 20. Otorhinolaryngology

The Department of Otorhinolaryngology, also known as the Department of Ear, Nose and Throat (ENT), has a long history of providing comprehensive clinical care, research and education in the field of otorhinolaryngology. The Department was established in the 1950s and has since then grown to become one of the leading ENT departments in South Africa.

From 2009 to 2018, the Department was led by Prof Mashudu (MI) Tshifularo. Under his leadership, the Department focused on clinical services, research, and education to students and medical professionals.

In 2008 and 2009, the Department started to provide cochlear implants for patients in underserved communities under the auspices of the Steve Biko Robert Kerr Cochlear Implants Project. In 2014, the Department graduated its first three black MMed specialists.

One of the main clinical services provided by the Department was the diagnosis and treatment of ear, nose and throat disorders. The Department provided surgical services for a wide range of ENT conditions, including head and neck cancer, sinusitis, and sleep apnea.

In terms of research, the Department was actively involved in a number of local and international research projects. Some of the main research areas included head and neck cancer, hearing disorders, voice disorders, and sinusitis. The Department also had collaborative research partnerships with other institutions, including the University of Limpopo and University of the Witwatersrand.

The Department provided undergraduate and postgraduate training in otorhinolaryngology to medical students, as well as ongoing professional development opportunities for practising medical professionals. It also hosted a number of conferences and workshops in the field of otorhinolaryngology.

During this time, the Department faced several challenges, including a shortage of qualified medical staff and funding constraints. However, it was able to overcome these challenges through its dedication to providing services, conducting cutting-edge research, and providing top-notch education and training opportunities.



Overall, the Department of Otorhinolaryngology played a leading role in advancing the field of otorhinolaryngology in South Africa from 2009 to 2018. Its commitment to clinical care, research and education helped to improve the lives of countless patients suffering from ear, nose and throat disorders, while also contributing to the ongoing development of the medical profession in South Africa and beyond.

## 21. Paediatrics and Child Health

The Department of Paediatrics and Child Health has a rich history dating back to January 1946. From 2009 to 2018, the Department expanded and improved its services, research and teaching initiatives and collaborated with other departments and institutions in the provision of comprehensive care to children with complex medical conditions.

In 2009, the Department was led by Prof Dankwaard (DF) Wittenburg who was succeeded by Prof Robin (RJ) Green who remained in the leadership position from 2010 to 2018.

The Department continued to focus on research and innovation during this period, focused on the four areas of academic medicine — patient care, research, teaching and community outreach. Throughout the review period, the five divisions were:

- Paediatric cardiology — Prof Farirai (F) Takawira
- Paediatric neurology — Prof Izelle (I) Smuts
- Paediatric nephrology — Prof Ida (G) van Biljon
- Paediatric gastroenterology — Dr Alta (AJ) Terblanche
- Paediatric pulmonology — Prof Robin Green.

In 2011, the Department was the only state paediatric service in South Africa to offer allogeneic stem cell transplants. The paediatric oncology unit performed two bone marrow transplants in 2011, and the unit met all the criteria set out by the South African Oncology Consortium (SAOC).

The Department also collaborated with other institutions to provide comprehensive care to children. In 2012, the Department established the UP/Netcare Initiative at Moot Hospital as a consultative service for paediatric neurology. The unit provides comprehensive care to children with neurological disorders, including epilepsy, cerebral palsy, and developmental delays.

In 2012, the Department established a new infectious disease unit that included the management of complex HIV patients. The unit provides comprehensive care to children with infectious diseases, including HIV/AIDS, tuberculosis, and pneumonia.

Overall, from 2009 to 2018, the Department of Paediatrics and Child Health continued to expand and improve its services, research and teaching initiatives. The Department collaborated with other departments and institutions to provide comprehensive care to children and their families and remained committed to excellence in paediatric care, research, and education.

Highlights during the review period included the following:

In 2010, a state-of-the-art isolation room was opened at Steve Biko Academic Hospital, especially for paediatric patients. The facility enabled immunocompromised children who had undergone stem cell transplants or chemotherapy to stay in isolation for up to three months after surgery.

In 2011, Prof Green was elected as the President of the College of Paediatricians at the Colleges of Medicine of South Africa. In the same year, the Department hosted a very successful annual UPdate meeting from 12 to 13 March 2011 at the CSIR Conference Centre. The UPdate event was held annually until 2019.

In 2012, the Department of Paediatrics at Kalafong Hospital hosted a very successful workshop on adolescent HIV care. Prof Theuns (T) Avenant, Head of Department of Paediatrics at Kalafong, delivered the opening address. Dr Ute (UD) Feucht, paediatrician and clinical head of the Kalafong Paediatric HIV services, concluded the proceedings.

Also in 2012, Prof Izelle Smuts hosted a Mitochondrial Symposium, with Dr Joanna (JL) Elson as an international guest speaker from Newcastle University (UK).

In 2013, Prof Ida van Biljon was awarded the Performance Excellence Award for the best medical doctor by the Gauteng Department of Health and the Steve Biko Academic Hospital. Prof van Biljon is a renowned paediatric nephrologist.

In 2015, Dr Talita (T) Ferreira-Van der Watt qualified as the first paediatric sub-specialist in Allergology in South Africa. Also in 2015, Prof Green presented a plenary lecture at the 5th World Congress on Virology in Atlanta (US). In 2016, Prof Ameena (AE) Goga won a prestigious Silver Medal Award from the South African Medical Research Council.



## 22. Pharmacology

The Department of Pharmacology has had a long and illustrious history of research, teaching and service in the field of pharmacology. From 2009 to 2018, the Department was led by a series of distinguished academics. From 2009 to 2015, Prof Opper (OBW) Greeff served as Head of Department until his retirement in October 2015. He was succeeded by Prof Vanessa (V) Steenkamp who held the position from November 2015 until the end of 2018.

Although the Department has seen many staff members come and go, each has brought expertise that remains in the Department. This was the same during the review period. The strength of the Department led to an increase in the number of postgraduate students over the past two decades. By 2018, the Department had the largest postgraduate student cohort in South Africa. The honours programme was extremely popular and attracted many students from across the country and abroad. The programme consists of three tracks: basic, clinical and regulatory pharmacology. The MPharmMed programme, initiated in 1974, has produced graduates who have made a significant contribution to drug development and regulation over many years.

The Department has maintained several laboratories covering all the required equipment for cell culture work and

cell biology studies, including fluorescence spectrometers, chemiluminometers, a research-type flow cytometer and a sophisticated triple quadrupole LC-MS/MS, as well as a microbiology laboratory. It also has the laboratory equipment and skills for carrying out proteomic assays which provide information on possible mechanisms of action or to identify which intracellular biochemical pathways are activated or deactivated due to drug exposure.

The phytomedicine unit has focused on the determination of biological activity of traditional herbal remedies in order to identify compounds with pharmacological activity, which could be developed as new agents in treatment of diseases. This Unit has continued to attract both national and international students at master's and doctoral level. Other assays routinely performed are used to determine the expression of protein surface markers of various cell types, anti-oxidant or free radical concentrations and mechanisms leading to cellular death.

In addition, the Department has had access to a well-established Clinical Trials Unit which was renovated and upgraded during 2009 to international standards and approved by the Federal Drug Administration. The Unit, managed by Dr Sophie (S) Mathijs, with support from Prof Paul (P) Rheeder as CEO and Prof Greeff in an advisory capacity, was officially opened on 27 August 2009. Clinical

research studies in various areas have been conducted. The Unit provides the opportunity to all clinicians in the School of Medicine to become involved in clinical research. The support of an experienced study coordinator team and a site dedicated for research has also been provided.

Staff members in the Department of Pharmacology have served as board members of various scientific societies both locally and abroad. Collaboration is fostered in the Faculty of Health Sciences, as well as between other UP faculties and universities and institutions nationally and internationally.

Research was a major focus of the Department during this time, and the high standard achieved was evident in the number of awards received by both students and staff. Research foci involved a wide range of studies, including drug development, drug metabolism, and toxicology. One of the major areas of research was the study of natural products for the treatment of diseases. Researchers in the Department were particularly interested in the potential of traditional African medicines to provide new sources of drugs.

In conclusion, the Department of Pharmacology made significant contributions to the field of pharmacology during the period from 2009 to 2018. The Department's research activities focused on drug development, drug metabolism, and toxicology, as well as the potential of traditional African medicines. It also played an important role in teaching and training, providing undergraduate and postgraduate courses in pharmacology. Service activities included the provision of drug information to health care professionals and the public. Finally, collaboration with a range of institutions strengthened the identity of the Department, as did its role in the wider community through public lectures and training activities.

Highlights of achievement in this review period included the following:

Prof Steenkamp obtained an NRF C rating in 2014. Also in 2014, a PhD student, Werner Cordier, was awarded the prestigious Innovative Pharmaceutical Association of South Africa (IPASA) award for best research in basic pharmacology for his research titled, 'An in vitro mechanistic evaluation of the hepatotoxic properties of *Solanum aculeastrum*'.

In 2016, Prof Steenkamp was nominated for the NSTF award in the category Research or Engineering Capacity Development. In 2018, Prof Steenkamp was elected as the President of the South African Society of Basic and Clinical Pharmacology. She was the first female president of the society. In the same year Prof Steenkamp was elected as

a member of the education and management division executive committee of the International Federation of Clinical Chemistry and Laboratory Medicine (IFCC).

The first conference of Biomedical and Natural Sciences and Therapeutics (CoBNeST) was held in Stellenbosch, with accolades for students and staff: The best oral presentation was awarded to Vulyelwa (V) Buque; Keith (K) Ncube was awarded second place, and Andrea Ellero was awarded third place. Vulyelwa Buque also won the award for the best poster and Dr Werner (W) Cordier received the educator's award.

## 23. Physiology

The Department of Physiology has had a long history of excellence in research and teaching. From 2009 to 2018, the Department continued to make significant contributions to the field of physiology through its research and teaching activities. In 2009, Prof Dirk (DH) van Papendorp was the Head of Department, a position that he had held since 1999. Prof Van Papendorp retired in 2014 and was succeeded by Prof Annie (AM) Joubert who held this position beyond 2018.

During this time, the Department focused on several research areas, including neurophysiology, cardiovascular physiology, respiratory physiology, endocrinology, and reproductive physiology. The Department's research output was consistently high, with many publications in top-tier journals and significant contributions to the field.

One of the Department's major research focuses was on the effects of exercise on physiological systems, particularly in relation to sports performance and health. The Department's researchers conducted several studies on the physiological effects of different types of exercise, including resistance training, endurance training and high-intensity interval training. This research contributed to a better understanding of how exercise affects the body and how it can be used to improve health and performance. In 2014, the Division of Biokinetics and Sports Science was incorporated into the Department of Physiology. This led to the establishment of the Institute for Sport, Exercise Medicine and Lifestyle Research (SEMLI), under the directorship of Prof Martin (MP) Schwellnus, in June 2015. The Division consists of staff members registered as Biokineticists with the Health Professions Council of South Africa. The new Bachelor of Sport Science (BSportSci), new Higher Certificate in Sports Science, as well as the postgraduate programmes associated with these degrees reside in the Department of Physiology.

## Section Sports Medicine

Sports Medicine is a division within the Department of Physiology that also feeds into the sports and research dimension of the SEMLI. Founded in 1999, this Division was still led by Prof Christa (DCC) Janse van Rensburg. She was supported by Dr Maki (M) Ramagole, who was the Chief Medical Officer for the Western Cape province at the Schools' Games in 2015, 2016 and 2017. Dr Rina (R) Grant was also a senior lecturer in the division. Dr Audrey (A) Janse van Rensburg joined the Section Sports Medicine in 2013.



The Department's undergraduate programme in Physiology was highly popular and attracted many students. The programme included courses in general physiology, neurophysiology, cardiovascular physiology, respiratory physiology, endocrinology, and reproductive physiology. The Department also offered a range of postgraduate programmes, including honours, master's and PhD programmes, which have provided students with the opportunity to conduct research in several areas of physiology.

Apart from training students for a specific occupation in the Health Sciences, Human Physiology was also taught as a basic science course to BSc students on the Hatfield Campus where they had the option of choosing Human Physiology as a major subject in the BSc (Medical Sciences), BSc (Human Physiology), or BSc (Human Physiology, Genetics and Psychology) degree

programmes. In addition to basic scientific research careers, these BSc students were equipped for a career in industrial physiology, neurophysiology, sport physiology, cellular physiology and psychology. A Human Physiology module was taught as a supportive discipline on the Hatfield Campus to BCommunication Pathology students in the Faculty of Humanities, as well as to BConsumer Science students in the Faculty of Natural and Agricultural Sciences. These courses included lectures and tutorials, as well as practical sessions.

During this time, the Department played an important role in community outreach and engagement. Researchers worked closely with health care providers and community organisations to promote health and well-being. Several outreach initiatives were undertaken to promote healthy lifestyles, such as exercise programmes for children and seniors.

The Department of Physiology was also active in promoting scientific exchange and collaboration. The Department hosted several international conferences and workshops that brought together researchers from around the world. These events helped to promote scientific exchange and collaboration, and contributed to the Department's reputation as a leading research institution.

In conclusion, from 2009 to 2018, the Department of Physiology continued to make significant contributions to the field of physiology through its research and teaching activities. The Department's focus on exercise physiology, pharmacology, and community outreach contributed to a better understanding of the physiological effects of exercise, drugs and lifestyle choices, and helped to promote health and well-being in the community.

Highlights included the following:

In 2011, Prof Joubert was awarded the AG Oettle Memorial Silver Medal by the Cancer Association of South Africa for her significant contributions in cancer research. In the same year, Prof Joubert was nominated for the prestigious 2011/12 NSTF BHP Billiton TW Kambule Award. Also in 2011, Dr Anne (AE) Theron was invited by Dr Laurence Lafanechere to visit the Department of Cellular Differentiation and Transformation at the Joseph Fourier University, Grenoble (France). Also in 2011, Prof Resia (R) Pretorius was named the Southern Region winner in the Basic Science, Technology and Innovation Sector of the African Union Kwame Nkrumah Scientific Awards.

In 2012, Prof Van Papendorp was awarded an honorary fellowship at the annual Physiology Society of Southern Africa conference held in Stellenbosch. He was recognised for his long and proud contribution and dedication to the medical profession and physiology.

In 2017, the Department hosted the 45th conference of the Physiological Society of Southern Africa at the Groenkloof Campus. There were 694 national and international delegates at the conference.

Also in 2017, Prof Christa Janse van Rensburg presented her research on the effects of international travel on elite athletes at the International Olympic Committee (IOC) World Conference held in Monaco. In the same year, Prof Martin Schweltnus received the 2017 American College of Sport Medicine (ACSM) International Clinical Scholar Award. This award recognises the top athlete care and/or clinical case paper submitted at the ACSM's annual meeting.

In 2018, Dr Alisa (A) Phulukdaree was chosen as the third Next Einstein Forum (NEF) fellow from the University of Pretoria. The NEF is a platform that connects science, society, and policy in Africa.

## 24. Psychiatry

The Department of Psychiatry provides education, research, and clinical care in the field of mental health. In 2009, the Department was headed by Prof Louw (JL) Roos until 2017. He was succeeded by Prof Pierre (PM) Joubert in 2018. During this time, the Department continued to build on its strong reputation in the field of psychiatry.

Alongside research and teaching, the Department also provided in-service training to mental health care providers in the Gauteng and Mpumalanga Departments of Health. Further, in the context of the staff members' various joint appointments within the Gauteng and Mpumalanga Health Departments, psychiatric services were rendered at Weskoppies Psychiatric Hospital, Steve Biko Academic Hospital and Witbank Hospital, as well as at community psychiatric clinics.

Research in psychiatry and psychology was done in five broad research fields: schizophrenia, physiology in psychiatry, clinical psychiatry and psychology, forensic psychiatry, and psychiatric service delivery. The research on the genetics of schizophrenia made up the bulk of neurosciences related research in the Department. In this field, the focus has been on elucidating the genetic architecture of familial schizophrenia by combining linkage analysis with studies of fine-level chromosomal variation in families recruited from the Afrikaner population in South Africa.

There were several broad research themes. The field 'physiology in psychiatry' has included studies on EEG changes during patients' acute experience of dissociative symptoms and studies on psychoneuroimmunology. The field of 'clinical psychiatry and psychology' has included numerous studies on the symptoms of various mental illnesses. Research on 'forensic psychiatry' has included studies on associations between psychiatric diagnoses and certain crimes. 'Psychiatric service delivery' refers to studies that have monitored the services that are rendered to patients in Weskoppies Hospital.

In the context of undergraduate medical training towards the MBChB degree, the Department of Psychiatry contributes to several blocks and special activities, as well as to the undergraduate medical curriculum.

Overall, the period from 2009 to 2018 was a time of growth and development for the Department of Psychiatry. Through its research, clinical care, and education activities, the Department made significant contributions to the field of mental health and helped to improve the lives of individuals and families affected by mental health conditions in South Africa and beyond.

Highlights during this review period included the following:

In 2012, Dr Gerhard (G) Grobler was elected President of the South African Society of Psychiatrists. In 2014, Dr Grobler was part of the organising team of the South African symposium on diagnostic systems and local psychiatry. The symposium was presented at the World Psychiatry Association in Madrid, Spain.

In 2013, Prof Werdie (W) van Staden was appointed as first professorial Chair in Philosophy and Psychiatry outside Europe. He was supported by the International Network of Philosophy and Psychiatry (INPP). Prof Christa (C) Krüger received a C rating from the NRF in 2013. In 2015, Prof Krüger was inducted as a fellow of the International Society for the Study of Trauma and Dissociation (ISSTD).

## 25. Radiation Oncology

The Department of Radiation Oncology is one of the most prominent departments in the Faculty of Health Sciences, known for its excellence in research, education and clinical practice. The discipline of radiation oncology forms part of the radiation sciences, comprising radiology, nuclear medicine, and radiation oncology. While radiology and nuclear medicine are concerned with diagnosing cancer, radiation oncology involves the treatment of cancer using high energy x-rays or photons.

Prof Jenny (JAG) Wilson was the Head of Department in 2009 until she passed away on 30 September 2009. On 1 October 2009, Dr Alain (AML) Hoceped rejoined the Department in the position of Acting Head and Principal Consultant. Prof Roy (RH) Lakier was appointed as Head of Department in 2011 and filled this position beyond 2018. The head radiographer was Zebeth (Z) Cronjé and the director of medical physics was Prof Ado (AJ) van Rensburg. Both Zebeth Cronjé and Prof van Rensburg held these posts until the end of the period under review. The Department undertook several research projects, leading to the publication of numerous scientific papers in peer-reviewed journals.

In 2012, the Department acquired a state-of-the-art linear accelerator machine, which allowed for more advanced radiation therapy treatment for cancer patients. This acquisition placed the Department at the forefront of cancer treatment in South Africa. By 2014, the Department became the first in South Africa to offer a specialised radiation therapy treatment known as Stereotactic Ablative Radiotherapy (SABR). This treatment allowed for more precise radiation therapy to tumours, reducing the risk of damage to surrounding healthy tissue. In 2018, the Department received a new linear accelerator machine valued at R41 million.

In 2018, the Department established a Palliative Care Unit to provide support for cancer patients and their families. The Unit offers emotional and psychological support, pain management and symptom control, ensuring that patients receive comprehensive care throughout their cancer treatment.

By the end of 2018, the Department saw approximately 2800 new patients per year. The number of new cases had increased by approximately 10% per year and were being referred from surrounding provinces including Mpumalanga and Limpopo. Throughout the period from 2009 to 2018, the Department's focus on research, education and clinical practice ensured that it remained at the forefront of cancer treatment in South Africa.

## 26. Radiology

Radiology is a field of medicine that uses various forms of imaging technology to diagnose and treat diseases. The Department of Radiology offers training to medical students, residents and fellows and provides diagnostic and interventional radiology services to various hospitals affiliated with the University of Pretoria. In 2009, the Head of Department was Prof Zarina (ZI) Lockhat, who held this position for the entire period under review.

From 2009 to 2018, the Department of Radiology experienced significant developments. Renovations improved infrastructure, including the installation of new imaging equipment and the expansion of existing facilities. In 2012, the Department acquired a new Siemens 1.5T Magnetom Essenza MRI scanner, which improved the accuracy and speed of diagnostic imaging.

The Department also expanded its services during this period, offering specialised imaging procedures such as CT and MR

angiography, mammography, and interventional radiology. The introduction of interventional radiology was a significant milestone for the Department as it enabled minimally invasive procedures such as biopsies, stent placements, and embolisation to be performed using imaging guidance, thus reducing the need for open surgery.

In addition to its clinical services, the Department of Radiology played a crucial role in research and academic activities at the University of Pretoria. The Department conducted various research studies on imaging technology and techniques, resulting in numerous publications in scientific journals. The Department also provided training and education to medical students, radiology residents and fellows, with a focus on improving the quality of health care and advancing the field of radiology.

The Department presented a specialised five-year residency programme. The programme aims to provide specialised training in diagnostic and interventional radiology to medical graduates, preparing them for a career in radiology. The residency programme was accredited by the Health Professions Council of South Africa and provided extensive training in various subspecialties of radiology, including neuroradiology, musculoskeletal radiology, and cardiovascular radiology.

In conclusion, from 2009 to 2018, the Department of Radiology underwent significant changes and advancements, including the introduction of new imaging equipment, expansion of clinical services, and expansion of academic and research activities. It played a crucial role in providing diagnostic and interventional radiology services to affiliated hospitals and training the next generation of radiologists in South Africa.

## 27. Surgery

The Department of Surgery at the University of Pretoria is one of the oldest and largest surgical departments in South Africa. It has a rich history of innovation, excellence in surgical training, and clinical research. In 2009, the Department was headed by Prof Hennie (JHR) Becker until 2012. The Department underwent a change of leadership in 2013, with Prof Taole (TR) Mokoena taking the helm.

The Department of Surgery was composed of four divisions, each headed by a specialist surgeon responsible for teaching and research in their respective fields:

- Paediatric surgery — Dr Ernst (EW) Müller (2009–2018)
- Cardiothoracic surgery — Prof Dirk (DJ) du Plessis (2008–2018)
- Vascular surgery — Dr Thanyani (TV) Mulaudzi (2016–2018 and beyond)
- Plastic surgery — Prof Petrus Francois (PF) Coetzee (2009–2015); Dr Solly (S) Selahle (2015–2018).

During this time, the Department of Surgery was heavily involved in the training of medical students, surgical residents and fellows. The surgical training programme was comprehensive, and included rotations through various surgical specialties, as well as research opportunities. In addition to training future surgeons, the Department was also active in clinical research. There were numerous ongoing research projects in various surgical fields, including cancer, trauma, and vascular surgery.

The Department also played an important role in providing surgical care to underserved populations. It regularly conducted outreach clinics in rural areas, providing much needed surgical services to people who otherwise would not have had access to them. By 2018, it remained a leader in surgical training, clinical research and innovation. It continued to attract some of the best and brightest surgical minds from around the country and the world, and remained committed to providing the highest quality surgical care to patients.

Some of the highlights in this period are listed below:

In 2011, the Department hosted the 39th Annual Meeting of the Surgical Research Society of Southern Africa, which was attended by 157 delegates and two international guests, Prof Andrew (A) Bradley (President of the Society of University Surgeons, UK) and Prof Hendrik (H) Thorlacious (President of the European Society of Surgical Research, Sweden).

Dr Brandon (BS) Jackson won the Bunny Angorn Prize for best presentation.

In 2011, Prof Hennie Becker was elected President of the Surgical Research Society of Southern Africa. Also in 2011, the Department of Surgery hosted the Colo-Drive, the annual congress of the South African Colo-Rectal Society.

On 11 April 2016, the Department of Surgery signed a collaboration agreement with Inqaba Biotechnical Industries to promote and increase the use of medicinal maggots for wound cleaning in South Africa. The agreement was signed by Prof Eric (E) Buch (the Dean), and Dr Oliver Preisig (Executive Director of Inqaba Biotec).



## 28. Urology

The Department of Urology has had a proud history of providing exceptional patient care, conducting innovative research, and training the next generation of urologists. From 2009 to 2018, the Department continued to build on its legacy of excellence and made significant strides in advancing the field of urology.

In 2009, the Department was led by Prof Evelyn (EM) Moshokoa, a renowned urologist and academic. Under her leadership, the Department was actively involved in clinical trials and research projects, including studies on prostate cancer and urinary incontinence.

The Department had four main focus areas: prostate cancer; male reproductive health; human and health impacts of

indoor residual spraying; and endocrine disrupting chemicals. The Department was the lead partner in the South African leg of an international prostate cancer study in collaboration with scientists from Australia and the University of Limpopo. The Head of Department at Kalafong Hospital was Dr Rasmi (RA) Abul-Feilat. Prof Riana (MS) Bornman was the Head of Andrology, and Dr Natalie (NH) Aneck-Hahn was the Deputy Director of Medical Natural Sciences. Andrology in collaboration with the School of Health Systems and Public Health was part of the Environmental Chemical Pollution and Health Research Unit.

The formal urological training programme retained its accreditation from the Health Professions Council of South Africa. The programme was designed to provide trainees with a comprehensive understanding of urology and the skills necessary to provide excellent patient care.



## 5 | Humanities

### DEAN'S OVERVIEW

The Faculty of Humanities at the University of Pretoria is widely recognised for its excellent contribution to education, research and societal engagement in languages, the social sciences and the arts. It continues to offer the most comprehensive range of courses and degrees in the country and has evolved to keep abreast with changes at UP and within society at large. The period 2009 to 2018 was no different. In terms of excellence in teaching and learning, postgraduate throughput and research outputs, the Faculty made significant improvements. Internationalisation remained an important objective, and several partnership agreements were concluded with international universities and many international scholars appointed as research associates and extraordinary professors.

#### *Leadership and structural change*

During the period under review, the Faculty of Humanities underwent a number of changes, both in structure and focus. Prof Sandra (S) Klopper resigned as Dean in 2011 and Prof Hennie (HF) Stander, Deputy Dean: Teaching and Learning, was appointed as Acting Dean until the appointment of Prof Norman (N) Duncan as Dean in 2012. During this period, Prof John (JM) Sharp served as Deputy Dean in the Faculty until his retirement in 2013. In 2014 Prof Duncan was appointed as Vice-Principal: Academic and Prof Stander again stepped in as Acting Dean. In August 2015 Prof Vasu (V) Reddy was appointed as Dean of the Faculty.

During his tenure, Prof Duncan established four clusters in the Faculty, aiming at bringing together the 18 departments, and the various research entities in the Faculty into like-minded groupings in order to promote inter-disciplinary collaboration in teaching and learning, and research. These were: Languages, Arts, Core Social Sciences and Applied Social Sciences.

Under Prof Reddy's leadership, the Arts cluster was restructured into a School of the Arts in 2018. The former departments of Music, Drama and Visual Arts now constituted the School of the Arts, which included elements of the former UP Arts Department. Under Prof Reddy, Prof Stander remained as Deputy Dean: Teaching and Learning, and the position of Deputy Dean: Postgraduate Studies and Research Ethics that became vacant after the resignation of Prof Sakhela (S) Buhlungu, was filled by Prof Maxi (M) Schoeman in early 2016.



l to r: Prof Maxi Schoeman, Prof Vasu Reddy and Prof Hennie Stander

## New directions

The organisational restructuring of the Faculty under Profs Duncan and Reddy points to a new direction for the Faculty, in line with changing trends in higher education, both locally and globally. Increasingly the Dean's office started focusing on leading the Faculty in a way that aligned to the University's 2025 Strategic Plan, with members of the Faculty taking a leading role in the development of the Plan. Prof Duncan focused on the identification of a number of research focus areas in the Faculty, viz. Peace and Conflict in Africa, The Child and the Story, Capital Cities: Space and Belonging, Visual Technologies, and a comprehensive project aimed at improving access to health care across the continent, with a special focus on audiology.

A generous award from the Andrew W Mellon Foundation supported the development of these focus areas into longer term multidisciplinary research clusters in the Faculty, allowing also for internationalisation, with the appointment

of international scholars to participate in the projects of these focus areas. It also served the purpose of focusing attention on the UP 2025 strategic goal of maintaining and further strengthening the University's reputation and standing as a research-intensive university in Africa.

Prof Reddy's arrival saw a further refinement of the Faculty's focus on teaching and learning, and research, with a growing alignment of programmes and projects with evolving local and global trends. Between 2016 and 2018 the Faculty embarked on a number of large-scale research programmes, funded by the Mellon Foundation, and spanning not only the already identified research focus areas, but all departments and research entities in the Faculty.

A key feature of the Mellon-funded programmes was the inclusion of postgraduate scholarships to promote postgraduate education in the Faculty, and to address the growing financial needs of students who wished to continue with postgraduate studies but who found it difficult to

finance their studies. The Arts and Humanities were given priority during this period, with interdisciplinarity increasingly foregrounded. This focus was supported by the University's large Arts project during the period under consideration — the conceptualisation and building of the Javett-UP Arts Centre. A new academic programme, the Master's degree in Tangible Heritage Studies (THC), with specialisation both in the arts and humanities, and the physical sciences, was developed between 2015 and 2018 and would enrol its first cohort of students in 2019. The THC programme is embedded within the Javett-UP Arts Centre and the University's range of museums, aimed at training future generations of tangible heritage conservationists from across the African continent. The programme is closely linked to internationally renowned museums, conservation centres and training programmes, among these at Yale, Delaware in the US and the Chhatrapati Shivaji Maharaj Vastu Sangrahalaya (CSMVS) Centre in Mumbai, India.

A second faculty-wide research programme embarked on by the Faculty — and in collaboration with several South African research-intensive universities (again funded by the Mellon Foundation) — was the Inclusive Professoriate, a concerted effort to assist with building a new generation of black South African academics within the professoriate in the Humanities and Social Sciences. This project, started during the deanship of Prof Duncan, was managed by Profs Reddy and Schoeman and in the period up to the end of 2018 saw several staff members being supported in building their academic profiles with a view to promotion into the professoriate, among them Prof Vusi (V) Thebe, Prof Shakila (S) Dada, Prof Thula (T) Simpson and Prof Siona (S) O'Connell.

An interesting development during the period under consideration is a change in the subsidy policy of the national Department of Higher Education and Training (DHET), now recognising artistic and creative outputs as formal research outputs. This policy change had an immediate and significant impact on the quality and volume of outputs in the Arts and Humanities, among others encouraging the development of a strong focus on film documentaries, with Prof O'Connell producing award-winning work.

Equally important, during the period under review, was the establishment of the National Institute for the Humanities and Social Sciences (NIHSS) in 2013. Aimed at advancing scholarship, research and ethical practice, the NIHSS has been offering scholarships for doctoral students and postdoctoral fellowships in the fields of the Humanities and Social Sciences, allowing the Faculty of Humanities to significantly improve the number of students graduating with a doctoral degree and

postdoctoral fellows. In addition, the NIHSS offers competitive research awards to academics, again placing the Faculty in a position of attracting funding for dedicated research that is relevant to the needs of the country and the continent.

## Decolonisation and transformation

The student protest movement, perhaps best characterised by the #RhodesMustFall and #FeesMustFall campaigns of 2015 and 2016, inspired the Faculty (and the rest of the University) to seriously consider the issue of decolonisation, especially with reference to academic programmes and course syllabi. One consequence was the establishment of a Transformation Committee in the Faculty. At an intellectual and research level, the Faculty, under the guidance of Prof Reddy, developed a comprehensive five-year research programme, 'The Decolonial Turn'. The project included the faculties of Humanities at the universities of Cape Town, Western Cape, Stellenbosch, KwaZulu-Natal, Rhodes, Free State and Witwatersrand. It was organised around theory and research, theory and teaching, and hidden curriculum and embedded practices. These themes served as thematic work clusters which incorporated the conceptual and organising frame. Underlying and supporting the thematic work clusters was an open online knowledge portal, which served as an archive and a repository of sources and resources to be used by all participating institutions, as well as other tertiary institutions in South Africa in order to share the knowledge and expertise generated by the partners.

In 2010, the South African government adopted its *National Development Plan 2030*, identifying a triple crisis in the country's development trajectory: poverty, unemployment and inequality. The Faculty's research started focusing increasingly on issues of inequality, broadly defined, and in late 2016 it developed a comprehensive research project, 'Justice and humanity: Challenging world (in)equalities'. The project created scope for a wide range of disciplines, from the arts to applied social sciences, to get involved in research around issues of inequality and social justice, whether locally or internationally.

In the mid-2010s a debate ensued nationally about the teaching of History as a compulsory school subject, and by 2017 the numbers of students in the Department of Historical and Heritage Studies had grown dramatically. In order to support this growth and deepen research in the Department, a programme focused on archival history, 'Engaging the Archive and the Counter-Archive', created a number of postgraduate scholarships and postdoctoral fellowships.



Prof Norman Duncan | Dean, 2012–2014



Prof Sandra Klopper | Dean, 2008–2011

Prof Reddy addresses prospective students during Welcoming Day



Again, the idea of inter- and transdisciplinarity was built into the programme, allowing for broad participation from across the Faculty of Humanities.

Similarly, a programme on public intellectuals, 'Public Intellectuals in Times of Wicked Problems', was conceptualised, and launched in 2017, on the basis that much is to be gained from studying the public intellectual in a broader socio-political and contextual dimension. This programme, located as a project in historicisation, brought new ways of thinking and learning into the Faculty as a result of the multidimensionality of interpretation that constituted the overall programme.

As part of the University's strategic objective of promoting diversity at all levels in the service of excellence, the Faculty's prioritisation of teaching and learning, and research saw a dramatic increase in areas of research specialisation and publication outputs, and internationalisation of both the student body and academics appointed, and a solid improvement in the throughput rates of undergraduate and postgraduate students.

The infographic on pages 240 and 241 shows progress against key performance indicators. In summary:

- Undergraduate module pass rates improved from 75,1% in 2009 to 85,2% in 2018, although the student:staff ratios had declined from 16,3 to 31,1 over the same period.
- The proportion of black undergraduate students changed from 32,7% in 2009 to 51,8% in 2018; and of black postgraduate students over the same period, from 42,1% to 50,8.
- Academic staff capacity improved, as illustrated in the increase of staff with doctoral qualifications, from 46,2% in 2009 to 72,2% in 2018. Over the same period the number of NRF-rated researchers increased from 18 to 48.
- Research output also improved from 169,67 output units to 224,96 over the same period, and the weighted research output from 0,71 to 1,51.

In addition to these metrics, there were several achievements and accolades which are detailed in the departmental summaries that follow.

**Prof Vasu Reddy** | Dean, 2015–2018 and beyond

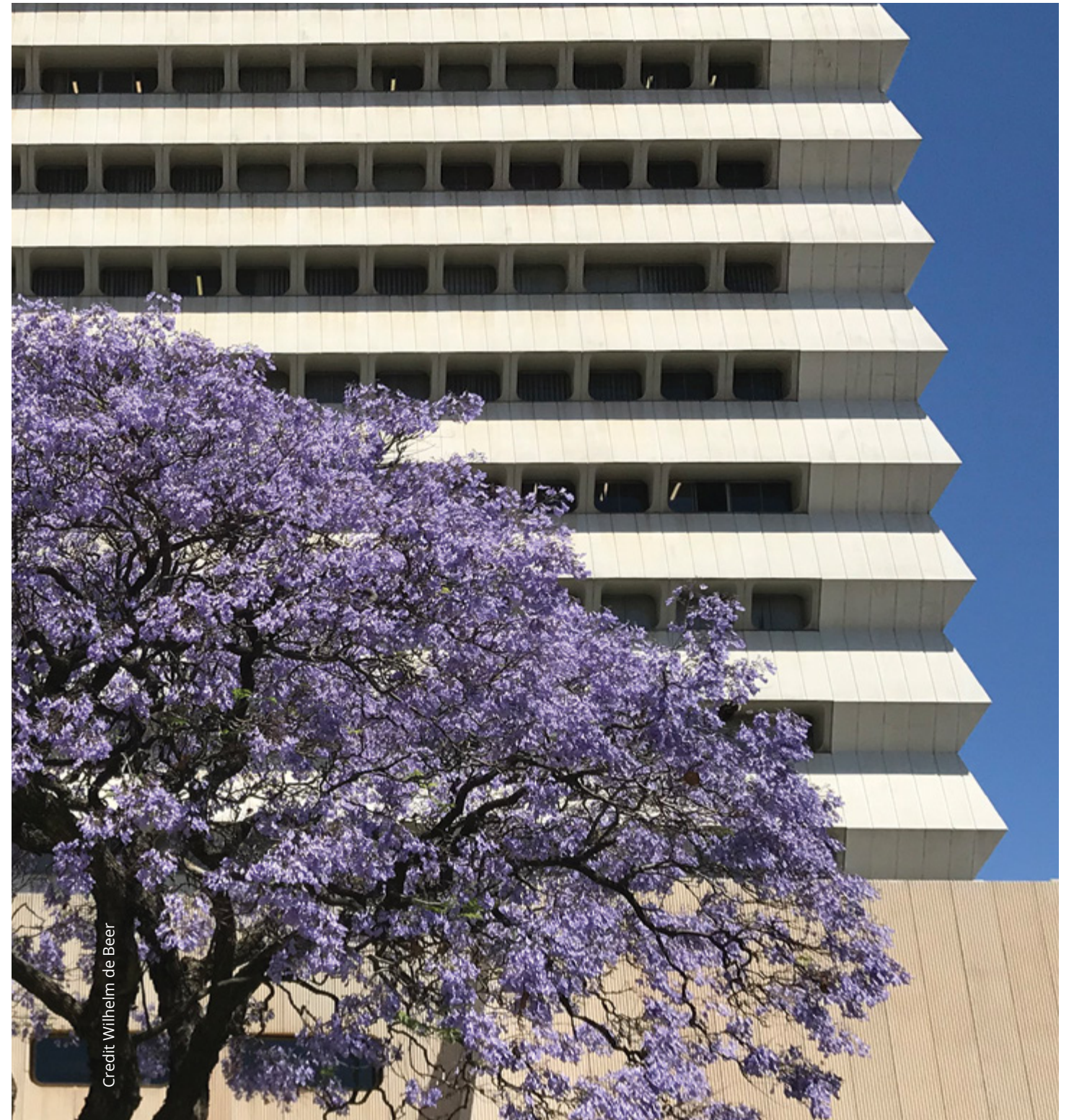

Credit: Wilhelm de Beer

# HUMANITIES: PERFORMANCE AT A GLANCE

## Enrolment and success

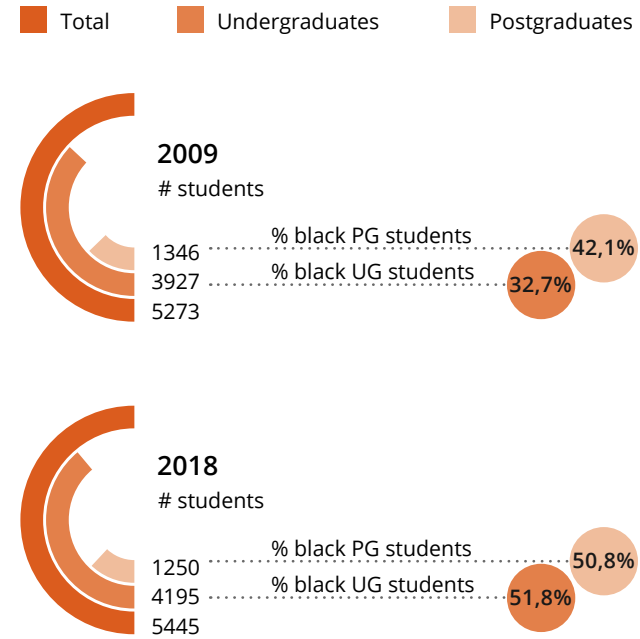

### Undergraduate module pass %

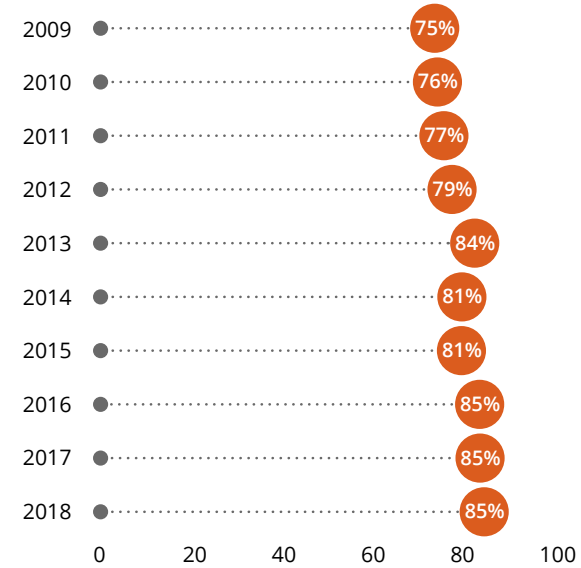

## UG graduates

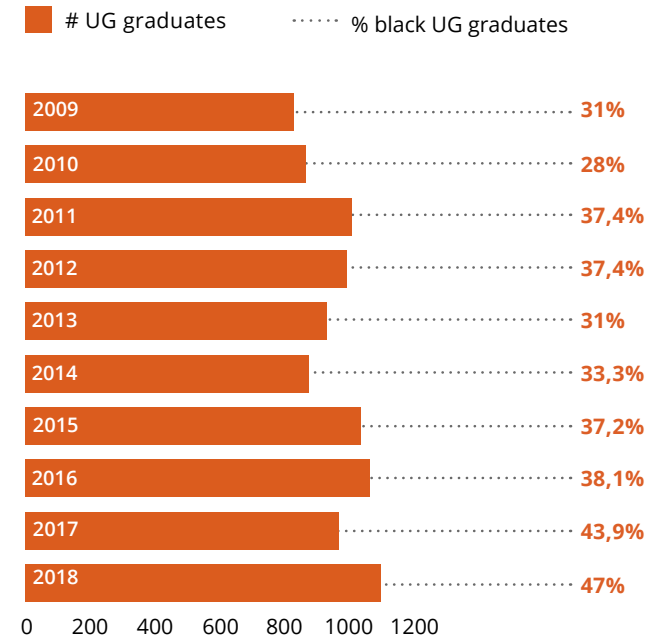

### Student : staff ratio

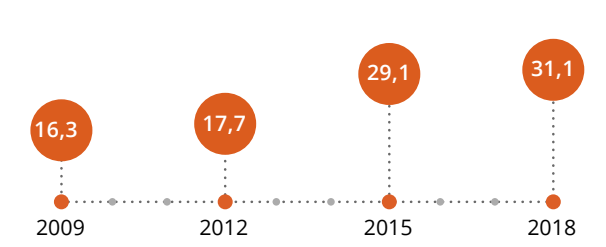

### Weighted M and D output

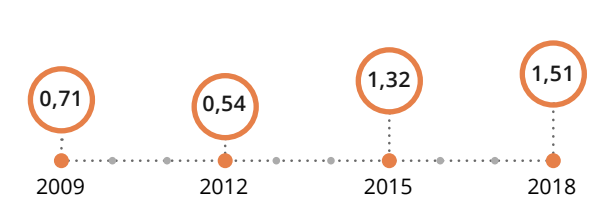

## Research pipeline

### M and D enrolment

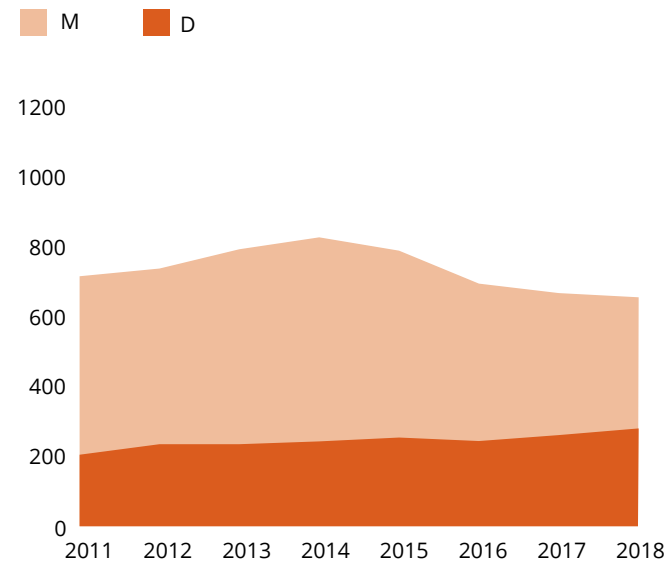

### M and D graduates

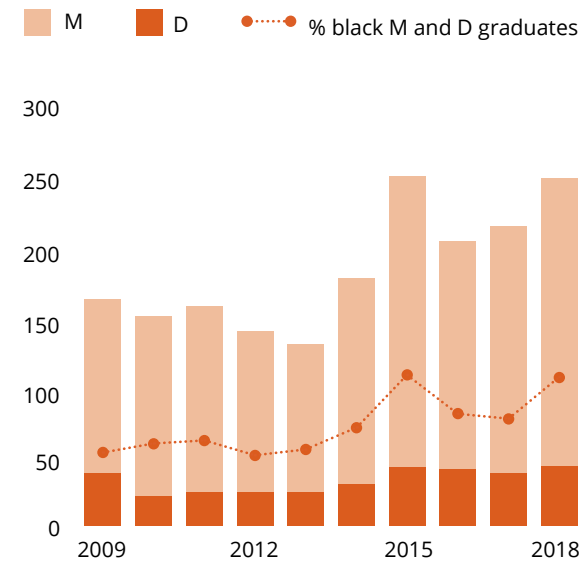

## Capacity and productivity

### % Academic staff with PhDs

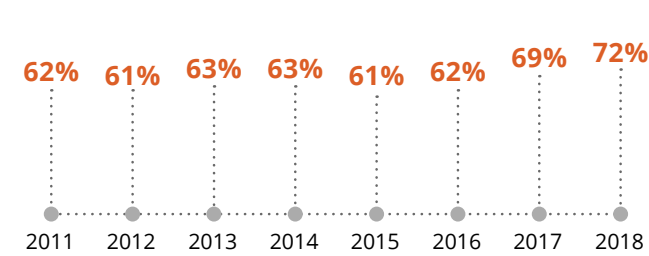

### NRF-rated researchers, 2018



### Research output

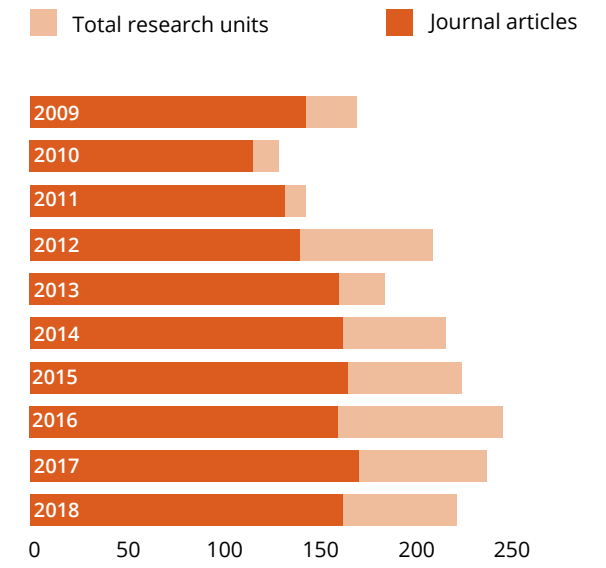



## DEPARTMENTS

## 1. African Languages

Prof Mawatle (MJ) Mojalefa was the Head of the Department of African Languages from the beginning of the period under review until 2012. He was succeeded by Prof Danie (DJ) Prinsloo in 2013 who served in this leadership position until the appointment, in February 2017, of Prof Nompumelelo (NB) Zondi as the new Head of the Department of African Languages. In the period leading up to the review period, the Department did not escape the effects of dwindling student numbers. By the end of 2009, the number of staff had been reduced from 19 to seven. In the context of these changes, the challenge was to maintain academic excellence.

The Department of African Languages maintained the quality of its teaching and research of African languages, linguistics and literature by focusing on innovative research and new teaching and learning strategies. The Department also continued to project an inclusive and enabling, value-driven culture that provided an intellectual home for the rich diversity of South African academic talent, whilst acknowledging the prominent role it needed to play in Africa and South Africa, and its active role in the transformation from Eurocentric to Afrocentric initiatives.

Renée (R) Marais joined the Department of African Languages in January 2015 from the Unit for Academic Literacy. She managed and taught Translation Studies, specifically the BA honours in Translation and Professional Writing, and the coursework master's in Applied Language Studies, with the option of Translation and Interpreting. These two postgraduate degree programmes afforded language students a career-oriented, professional degree in various aspects of language practice, mostly editing, translation and interpreting in a number of language pairs. A large number of students also obtained research master's degrees that focused on a translation or an interpreting topic.

**Highlights of achievement**

In the period under review, Prof Danie Prinsloo and Prof Elsabé (E) Taljard obtained respectively B and C NRF ratings. Prof Prinsloo was also acknowledged by UP for exceptional academic achievement in two annual Academic Achievers' Awards, respectively in 2012 and 2014.

The University of Pretoria, as the host of the South African Centre for Digital Language Resources (SADiLaR) digitisation node, continued to bring technological development for African languages on par with the best that exists for major languages of the world. SADiLaR (<https://www.sadilar.org/index.php/en/>) is a state-funded project, aimed at creating digital resources for the African languages of South Africa. These resources are essential for research on the African languages, and the development of human language technologies. The main goal of the Department's digitisation node in the period under review remained the digitisation of valuable material that would otherwise be lost, with sources including videos, audio material and text.

In partnership with UP's Department of Information Science and commercial programmers, the Department worked on the compilation of Sepedi support tools for teaching and learning and text production (e.g., for use as a support tool in an electronic dictionary, sentence building and generating complex grammatical constructions), as well as online learning courses.

During the review period staff members served on several national and international associations and committees. Two staff members served on the board of Afrilex, the African Association for Lexicography. They were also part of the rotating editorship of *Lexikos*, an internationally recognised journal that publishes lexicographic research. The Department was also represented on the steering committee and the scientific advisory committee of SADiLaR, and staff served on the editorial boards of a number of international journals.

Publications in the period under review largely focused on African languages, linguistics and literature. In literature research, there remained a strong focus on gender issues, as reflected in the literature of the different languages, and also the revitalisation of the work of scholars who had been marginalised in the past.

The Department remained recognised as a leader in research on lexicography and terminology of African languages. In 2011, Prof Prinsloo and co-researcher Prof Ulrich Heid (Stuttgart University) won the Via Afrika award for the best article on linguistics published in the *South African Journal of African Languages*.

## 2. Afrikaans

Prof Willie (W) Burger was appointed as the Head of the Department of Afrikaans in 2010. He succeeded Prof Hein (HSS) Willemse who was in this leadership position until 2009. Prof Burger's appointment was renewed for two more terms, respectively in 2014 and 2018. The focus in the period under review was on repositioning the Department in the context of several changes, among which were the decline in student enrolments. While students in the Faculty of Education boosted enrolment numbers, Afrikaans was, since 2012, no longer a requirement for Law students.

At the level of the curriculum, the Language, Culture and Communication modules were discontinued during the period under review.

There were several staff changes: Neeltjie (N) Celliers, the Department Administrator, retired in 2011 after 24 years at UP, and Heinrich (HCHF) Ohlhoff retired in 2014, receiving a certificate for 40 years of service at UP. Sadly, Prof Heinrich (H) Grebe passed away in 2011. Dr Annette (AM) Jordaan, who published several popular romances under the pseudonym Magda Schmidt, retired in 2015. Prof Andries (A) Visagie joined the Department in 2011 as an associate professor for Afrikaans and Dutch Literature. He left at the end of 2015 to take up the position as Head of Department at Stellenbosch University.

**Research highlights**

The focus of the Department on research and scholarly writing was reflected both in departmental research projects and in the achievements of individual staff members.

A notable research project, headed by Dr Nerina (N) Bosman, started in 2017 on forms of address in Afrikaans. In 2015, Prof Burger was the recipient of the Caxton-Magazines Award in the category Best Reviewer. In the same year he also received the award for the best scholarly article, 'Historiese korrektheid en historiese fiksie: 'n respons' by the *Suid Afrikaanse Akademie vir Wetenskap en Kuns* (SAAWK). In 2016 he received the kykNET-Rapport-prize for Book Reviewer of the Year. Prof Burger also served on the editorial board of *Tydskrif vir Letterkunde*, *Stilet* and *Tydskrif vir Geesteswetenskap*, the Literary Commission of the SAAWK responsible for, among other matters, the Hertzog Prize.

Dr Bosman was promoted to associate professor in 2017 and her article, 'Eet en drink in Afrikaans — 'n leksikaal-semantiese ondersoek', received a prize for the best linguistics article published in 2015. In 2016, she was appointed as chairperson of the South African Society for Netherlandic Studies; she also served on the Council of the *Internationale Neerlandistiek* (International Netherlandic Studies).

Dr Suzan (SS) Thembekwayo received her PhD in education in 2011 and took early retirement in 2016 to take up a position as a member of the South African National Assembly.

Prof Willemse became the first appointee to the University of Ghent in the Special Chair for South African Languages, Culture and Society in 2018, and remained the editor-in-chief of *Tydskrif vir Letterkunde*. Dr Jacomien (J) van Niekerk received her PhD in 2014 and her article, 'The national question in Antjie Krog's *Transformation Trilogy*' (2017), received the Thomas Pringle award from the English Academy of Southern Africa for the best research article (2017-2018).

Dr Suléne (S) Pilon joined the Department in 2012 as a lecturer and served as deputy chair of the Language Committee of the SAAWK. She was also responsible for the publication of the eleventh edition of *Die Afrikaanse woordelys en spelreëls* (The list of Afrikaans words and spelling rules), published by the SAAWK in 2017. Dr Bibi (B) Burger was appointed as lecturer in 2016 and became a research fellow of the American Council of Learned Societies' African Humanities Program in 2018.

With respect to notable student achievements during the review period, Anneli Groenewald completed her MA in Creative Writing under supervision of Prof Burger in 2015. She completed the novel, *Die Skaalmodel*, for which she received the debut prize in the NB Publishers Great Novel Competition.

## 3. Ancient and Modern Languages and Cultures

The former departments of Ancient Languages and Cultures, and Modern European Languages merged in January 2018 to become the Department of Ancient and Modern Languages and Cultures. Prof Rada (R) Tirvassen was appointed as the new Head of Department. Before the merger, Prof Henk (JH) Potgieter was the Head of Department of Ancient Languages (1993 to 2017), and Prof Stephan (S) Mühr of the Department of Modern European Languages (2007 to 2013).



## Highlights

Module changes during the review period included:

- The phasing in of Spanish (since 2008) and of Portuguese (since 2014) as part of the BA programmes
- In 2013, the introduction of an interdisciplinary MA in African-European Cultural Relations
- In 2014, the introduction of BA honours and master's programmes in Spanish
- Further, in 2011 all Modern European Language programmes were changed to allow beginners to complete a three-year BA degree (previously four years).

There were several staff highlights during the period. Four doctoral degrees were awarded, respectively to Anna-Marie (AM) de Beer (2014), Angelika (A) Weber (2014), Jo-Marí (JM) Schäder (2016) and Luis (LA) Lancho Perea (2017). In 2014 Prof Tirvassen obtained a fellowship from the Japanese Society for the Promotion of Science and spent five weeks at the University of Kyoto for research in francophone sociolinguistics. In 2015, Prof Mühr was granted a research

fellowship to spend time at the Institute for Advanced Study at Konstanz University, Germany.

Although postgraduate student numbers remained relatively low, the Department also saw the emergence of two important opportunities during this review period. In collaboration with the North-West University, resources were pooled in a joint lecturing project that involved the French and German honours programmes. There had also been systematic support from foreign Embassies (Austria, Brazil, France, Germany, Portugal and Spain, in particular), which involved student exchange programmes, visits abroad, the supply of teaching material, teacher training and secondment, volunteers, or financial support.

Some events hosted during the review period included, in 2011, the hosting of the 25th conference of the Association of German Studies in Southern Africa (SAGV) at UP, attended by about 80 participants from 15 countries. In 2013, the Department hosted the German-African Network of Alumni and Alumnae (GANAA) Summer School at UP, 'Practising Multilingualism in (Higher) Education in Africa', which attracted around 60 participants from 16 African countries.

## 4. Anthropology and Archaeology

The Department of Anthropology, Archaeology and Development Studies is an example of the successful implementation of a decolonised and contextualised curriculum in response to a changing world. The importance of curriculum change was premised on the idea that the social sciences and societal needs share an intimate relationship and that disciplines are in their finer analysis about humanity and humanism.

Prof Innocent (I) Pikirayi was appointed as Head of Department in 2010 and remained in this leadership position beyond 2018. His predecessor, Prof John (JS) Sharp, was Head of Department from 2001 to 2009 and initiated several of the changes that came to fruition in the decade that followed.

### Highlights and achievements

#### Anthropology

In Anthropology, the transformation that began with the name change from *Volkekunde* to Anthropology extended over time to a number of structural and curriculum changes. Prof Sharp, initially assisted by Prof Sakkie (I) Niehaus and Prof Sue (SE) Cook, had recruited Profs Rehana (R) Vally, Owen (O) Sichone and Elaine (E) Salo, and later Prof Fraser (FG) McNeill and Dr Detlev (D) Krige.

The academic expertise provided by the reconfigured Anthropology team facilitated the broadening of the academic focus to include research and teaching in ethnicity, identity, gender, xenophobia, human rights and more, reflecting both an African and international context. Moreover, the team broadened academic contact with institutions in African countries and beyond, including collaborations in Nigeria, Cameroon, Mozambique and Senegal, and with institutions in the Netherlands, France, the US and the UK.

#### Archaeology

Transformative changes in Archaeology reiterated the importance of decolonising the curriculum to reflect the democratic socio-political milieu of post-apartheid South Africa. Prof Pikirayi provided strategic direction to the transformation of Archaeology from an inward looking discipline to one that would achieve international recognition. Prof Pikirayi, together with Drs Maria (M) Schoeman and Doris (D) Cruz from the College of William and Mary (US), and the expert assistance of Prof Rod (R) MacIntosh from Rice University (US), redesigned the curriculum. The curriculum

change introduced was manifest, for example, in the different approaches adopted in the preservation and study of the Mapungubwe collection.

The excavation of the Mapungubwe sites yielded artefacts that were hidden from public interest. Making these artefacts visible and accessible for public viewing and academic research was an important step in decolonising Archaeology. This not only created the opportunity for Archaeology at UP to take its place alongside other Archaeology departments at South African universities, it was also about reimagining the links between the state and the discipline. The requests from government to assist in the repatriation of human remains and the repositioning of the Mapungubwe collection as part of our African heritage also emphasised the Department's resolve to decolonise its teaching and learning and approaches to research.

The departure of Drs Cruz and Schoeman and later Dr Ouzman saw the appointments of Prof Ceri (C) Ashley and Drs Alexander (A) Antonites and Ndukuyakhe (N) Ndlovu, respectively in the years 2011, 2011 and 2013, while Dr Tim (T) Forssman joined the Department as a replacement for Prof Ashley in 2020. This team, under the guidance of Prof Pikirayi, elevated Archaeology out of relative obscurity to become one of the top 200 leading Archaeology research departments internationally in the QS rankings in 2016 and 2017.

#### Heritage and Cultural Tourism

The Heritage and Cultural Tourism component, which was introduced in 1998, continued to grow during the period under review. In 2009, Prof Chris (C) Boonzaaier became part of the international African-European academic alliance for the research project on sustainable tourism development, environmental sustainability and poverty reduction, funded by the European Union and administered by the University of Wageningen (The Netherlands). The aim was to improve the tourism curriculum at tertiary institutions in Africa and to promote research in tourism. When Prof Boonzaaier retired in 2017, the programme was taken over by the Department of Historical and Heritage Studies. The two departments were jointly responsible for the programme until 2017.

#### Development Studies

Development Studies as an academic discipline in the Department was relatively new. Introduced in 2013, it replaced Community Development, which during early post-colonialism was central in developing and providing blueprints for development interventions. However, it was



limited in scope and could not accommodate the complex development demands of a changing context. Development Studies offered only postgraduate programmes in a range of fields, adopting an integrative transdisciplinary approach that brought together disciplinary areas such as Historical and Heritage Studies, Political Sciences and International Relations and Sociology in the Humanities, and Agriculture and Extension Services, Economics, Environmental Sciences, Human Rights and Public Administration in other faculties at UP. The programme was led by Prof Sharp who was also the Co-Director of the Human Economy Programme.

Prof Vusi (V) Thebe, appointed in 2015, took over the coordination of the programme and was pivotal to its further development. Development Studies continued to attract large numbers of postgraduate students, making it perhaps the subject of choice in the Department. Under his leadership the honours curriculum was reviewed in line with the changing development emphasis and the complexity of the world of development practice, with the new curriculum offered since 2016. The Department was also able to expand its research activities into development aspects.

## Achievements

Staff achievements during the review period included Prof Pikirayi receiving the Faculty Researcher of the Year Award in 2014 and 2016, and Profs Thebe and McNeill respectively the Faculty Researcher and Lecturer of the Year Awards in 2017.

The Department raised substantial external research funding to support research in Archaeology and postgraduate research and training during the review period. This included an equipment grant received from the National Research Foundation (NRF) to develop research capacity in Archaeology, and the refurbishment of the archaeology laboratory facilities on the South Campus from UP's own funds.

## 5. English

Prof Andries (JA) Wessels served as Head of the English Department from 2009 to 2014 and was succeeded by Prof Molly (MA) Brown in 2014. The period from 2009 to 2018 focused on rationalisation and renewal rather than expansion

as steeply rising undergraduate student numbers forced the Department to reconsider what was possible and sustainable.

In general, the English Department, which taught more than 3 000 undergraduates annually during the period under review, continued to contribute substantially to teaching and learning at UP and also managed to increase its research output significantly. To this end, significant changes had to be made with regard to four key areas.

### Journalism

The years 2010 to 2014 constituted the golden age of Journalism training at the University of Pretoria, and the reasons for its cancellation after 2014 were complex. In 2012, the BA Languages (Journalism) and undergraduate modules in journalism were phased out in favour of a one-year honours course. Although this was considered best practice, it did make the course expensive, with three full-time lecturers teaching one honours programme; there were two full-time appointments and a third post dedicated to the appointment of expert guest lecturers. Prof Pippa (P) Green, the Head of the Journalism programme, resigned in 2014 to take up a position at the University of Cape Town; in the same period, Marenet (M) Jordaan accepted a position at Stellenbosch University. The closure of the journalism honours programme, nominally located in the Department of English, coincided with tripling student numbers in undergraduate English modules.

### English Studies

Between 2015 and 2019 the specialist BA Languages (English Studies) degree was phased out, though elements of its third-year modules have continued to be offered to honours students. These modules have attracted students from all parts of South Africa.

### The Unit for Creative Writing

Following the resignation of Prof Henning (HJ) Pieterse, the former director, in 2014 and a period in which the Unit for Creative Writing was largely dormant, it was relaunched in October 2017 with Prof David (D) Medalie, a successful writer and full professor in the English Department, as the new Director. The relaunch was very successful. A significant number of new students have since enrolled and UP has benefitted from the widespread interest in creative writing and its development as an academic subject. The Unit offers only postgraduate degrees: an MA and a PhD in Creative

Writing, although there is also an honours module in Creative Writing, which is housed in the English Department.

### Editing and English Foreign Language (EFL) short courses

EFL short courses managed by Dr Patrick (PC) Lenahan continued to run in partnership with CE@UP and grew from small beginnings to a lucrative enterprise. By 2013, when the courses ended due to staffing constraints, they were serving more than 200 students from across the globe. The students were largely either international postgraduates and staff members at UP, or members of the diplomatic corps and their families. During this period, a course in editing was developed by Dr Idette (I) Noomé, which is accredited by the South African Editors' Forum.

### Achievements and challenges

A major challenge for the Department of English was the dramatic increase in student numbers without a corresponding increase in staff. The increase in students was in part due to the repatriation of English modules offered by the Faculty of Education to the Department of English, starting in 2011, and the high numbers of Law students who were required to register for English modules. This unprecedented increase in student numbers had substantial implications for teaching and research in the Department.

The disruptions brought about by the #FeesMustFall protests in 2015 and 2016 also posed serious challenges. However, engagement with students and the issues raised by them offered opportunities to reinvigorate syllabi and experiment with new modes of teaching and more flexible, hybrid approaches to both teaching and learning.

Curriculum changes during this period included, for example, an increased focus on Africa and contemporary world literature in undergraduate modules. The research essay, previously an optional module in the honours degree, became compulsory and continues to provide training in vital research skills for our students.

There were also important research and creative output achievements during this period; in overview:

- Prof Medalie published several creative works that won widespread acclaim. During this period, Prof Medalie maintained his C2 NRF rating and won the faculty supervisor of the year award in 2018.



- Prof Wessels's research into South African and Modernist literature led to him receiving a C3 rating from the NRF in 2013.
- Prof Brown, a pioneer in her study on children's literature in South Africa, ensured that the Department was generally recognised as the best place for postgraduate students wishing to work in this field. Her work was acknowledged when she received a C3 NRF rating in 2017.
- Prof Corinne (CL) Sandwith received a C2 rating from the NRF in 2017, and won the UP Vice-Chancellor's Book Award in 2016 for her book, *World of Letters: Reading Communities and Cultural Debates in Early Apartheid South Africa* (University of KwaZulu-Natal Press, 2014).
- Dr Rebecca (R) Fasselt, who joined the Department in 2015 as an African literature specialist, was awarded an NRF Y rating in 2018.
- Prof Russell (R) West-Pavlov (2013–2014) joined the Department from the Freie Universität Berlin, Germany and soon received a B2 rating from the NRF. Although forced to leave UP for family reasons in mid-2014, he sustained his collaboration with colleagues at UP and made a considerable contribution to both the research culture of the Department and to curriculum innovation. In 2018 he co-authored, with John Kinsella, *Temporariness: On the Imperatives of Place*; in the same year he was editor of *The Global South and Literature* (Cambridge University Press).
- Dr Colette (C) Guldemann was awarded a Knight Nieman Fellowship at the Nieman Foundation for Journalism at Harvard (2018), and Dr Nedine (NL) Moonsamy was named one of the *Mail and Guardian's* 100 young South Africans to watch (2016).

Research remained largely independent and aligned with individual skills and interests. However, since 2015, the Department has become involved in several major cross-institutional and international research projects; examples include:

- Dr Moonsamy and colleagues as well as a number of postgraduate students contributed to the intra-Africa Mellon focus area research project on urban cultures and popular imaginaries, based at Rhodes University, planned to run from 2017–2021.
- Prof Sandwith played a key role in the Minor Cosmopolitans project hosted by the University of Potsdam, Germany.

- In 2018 Prof Brown and Prof West-Pavlov were successful in winning an Erasmus+ grant to support staff and student exchanges between the University of Pretoria and that of Tübingen, Germany.

There were also several highlights in student achievements: Michelle (M) Joubert was awarded a Fulbright scholarship in 2011; three students were Chancellor's medallists, Marguerite (M) de Waal (2012), Kirsten (KC) Dey (2014) and Kaleela (KS) Callaghan (2015); and a number of students — including Georg (TG) Nöffke, Nicole (N) Best, Dewald (DM) Steyn and Christiaan (C) Naudé — published creative works in journals such as *New Coin* and *New Contrast*.

## 6. Historical and Heritage Studies

The Department of Historical and Heritage Studies is a leading history department in South Africa, and one of the largest. With growing student numbers and increased research output, achieving a balance between research, the quality of teaching and curriculum relevance remained central to its identity during the period under review.

There were several leadership and structural changes during this period. Prof Johan (JS) Bergh retired as Head of Department in 2011 having served in the position for 25 years (1986 to 2011). He was succeeded by Prof Alois (AM) Mlambo who held this leadership position from 2012 to 2017 until his retirement. Prof Karen (KL) Harris was appointed in 2017 as the first female Head of Department.

In 2018, there were eight permanent staff in the department. Prof Fransjohan (F) Pretorius and Dr Jackie (JEH) Grobler retired in 2014 and 2017 respectively, Thatisi (TA) Machaba left UP in 2014, and Dr Lize (L) Kriel joined the Department of Visual Arts in 2017. Research and teaching capacity were strengthened by retaining the services of visiting and emeritus professors and the appointment of postdoctoral fellows.

### Research highlights

The Department continued to be one of the leading departments in the Faculty of Humanities with respect to research outputs. Highlights included three large-scale research projects, the 2018 Archives projects funded respectively by the Higher Education Funding Council for England (HEFCE) Newton Fund and the Andrew W Mellon Foundation of New York City, with Prof Harris as Principal Investigator in both projects, and the National Department of Tourism projects (2012–2018), also led by Prof Harris.

A number of outstanding scholarly books were published during this review period.

Prof Charles (C) van Onselen, a senior research fellow at the Centre for the Advancement of Scholarship and emeritus professor in the Department, published three books:

- *The Cowboy Capitalist: John Hays Hammond, the American West, and the Jameson Raid in South Africa* (Jonathan Ball Publishers, 2017)
- *Showdown at the Red Lion: The Life and Time of Jack McLoughlin* (Jonathan Ball Publishers, 2014)
- *Masked Raiders: Irish Banditry in Southern Africa 1880-1899* (Protea Boekhuis, 2010).

Prof Alois Mlambo also published three books, two of which were co-authored:

- *A History of Zimbabwe* (Cambridge University Press, 2014)
- A Mlambo and N Parson, *A History of Southern Africa* (Red Globe Press, 2019)
- A Mlambo and B Raftopoulos, *Becoming Zimbabwe: A History of Zimbabwe from the Pre-Colonial Period to 2008* (Jacana Media, 2009).

Prof Fransjohan Pretorius published two books:

- *Verskroeiende aarde* (Tafelberg, 2017)
- *History of South Africa – from the distant past to the present day* (Protea Boekhuis, 2014).

Three more books were published by staff in the department:

- Ian (IM) Macqueen. *Black Consciousness and Progressive Movements Under Apartheid* (University of KwaZulu-Natal Press, 2018)
- Johan (JS) Bergh. *Paul Kruger – toesprake en korrespondensie 1881-1900* (Protea Boekhuis, 2017)
- Thula (T) Simpson. *Umkhonto we Sizwe: The ANC's Armed Struggle* (Penguin Random House SA, 2016).

An outstanding student achievement was that of Dr Fred (FG) Brownell who was the recipient of the Vexillon award by the international Fédération Internationale de Associations Vexillologiques for his doctoral thesis, 'Convergence and unification: the national flag of South Africa (1994) in historical perspective.' He was also recognised as a 'Laureate of the Federation'. He designed the flags for Namibia and South Africa and completed his PhD in 2015, supervised by Prof Karen Harris.

## Curriculum and students

At the level of programmes and modules, there were several changes:

- The subject and degree qualification for Cultural History was removed at both undergraduate and postgraduate levels.
- The first year, first semester module GES 110, which was students' first engagement with the study of history, was changed significantly.

In keeping with debates on decolonising and transforming higher education, this distinctly Eurocentric module was replaced with a module on World History, which shifted the lens of Historical Studies to a global world rather than exclusively on western civilisations.

Further changes at postgraduate levels included the introduction in 2014 of a film module as an honours elective, World History in Film (GES 715).

The Museums Studies programme (MKD) was also completely restructured and a new programme in Tangible Heritage Conservation (THC) developed with the first master's degree student intake planned for 2019.

Both History and Heritage postgraduate students remained an integral part of the Department with numbers steadily increasing in the period under review; by 2018, the cumulative numbers were: honours (134), master's (41), doctoral (16). Students were involved in several projects and activities. The following are to illustrate:

The History postgraduates were involved in and hosted several events, including a postgraduate skills training workshop hosted by the Oppenheimer Trust at UP (March 2012); a similar workshop hosted by the Archive for Contemporary Affairs held at the University of the Free State (November 2013); and a 'Think in Ink II' graduate workshop hosted by the Southern African Historical Society (SAHS), held at Stellenbosch University (February 2015).

The Heritage and Cultural Tourism postgraduates involved in UP Campus Tours, an integral part of the practical component of their EFK 752 module, were particularly busy during this period. The UP Campus Board Game (2012) won the MACE (Marketing, Advancement and Communication in Education) excellence award as the overall national winner in the category, Internal Communication. The UP Campus Tours team of 2011 created and developed this game with Prof Harris and UP Archive staff. Other events were the 'Walk

through Time' (2011); Ten-year Reunion (2013); Heritage Race (2014); Green Tour of Campus and Amazing Race (2015); Museums beyond Walls (2017).

## 7. Philosophy

At the start of the period under review, Prof Deon (GJ) Rossouw was serving as Head of Department, a position he had held since 2004. He resigned in 2011 and a new Head of Department, Prof Emma (EB) Ruttkamp-Bloem, joined the Department from the University of Johannesburg. In September 2014 she stepped down as departmental head and alumnus professor Etienne (DE) de Villiers was appointed as Acting Head, a position he filled until February 2017 with the arrival of Prof Leonhard (L) Praeg who joined UP from Rhodes University.

In 2013, the Department appointed Mpho (MT) Tshivhase as its first black staff member and in 2018 she became the first black African woman in South Africa to be awarded a PhD in Philosophy. In 2018, Dr Tshivhase was elected as president of the Philosophical Society of Southern Africa (PSSA). In 2017 the Department appointed Keo (KG) Mbebe as a lecturer in the Department, followed by the appointment of Dr Jonathan (JO) Chimakonam as a senior lecturer in 2018.

### Achievements and change

During the period under review, two staff members achieved NRF B-rated status, namely, Profs Ernst (E) Wolff and Ulrike (U) Kistner, and two internationally renowned scholars, Profs Reingard (R) Nethersole (University of Richmond, US) and Philippe (P) van Houte (Radboud University in the Netherlands) continued to serve as extraordinary professors in the Department. In 2016, Prof Marinus (MJ) Schoeman retired and in 2017 Prof Wolff joined KU Leuven in Belgium; he remained affiliated to the Department as a research associate.

There were important programme changes in this period:

In 2012, the Centre for Business and Professional Ethics was moved from the Department of Philosophy to the Albert Luthuli Centre for Responsible Leadership, associated with the Faculty of Economic and Management Sciences (EMS). The Department continued to teach professional and business ethics modules to students in EMS.

In 2013 Prof Ruttkamp-Bloem initiated the establishment of an undergraduate degree in Politics, Philosophy and

Economics (PPE). Hosted by the Philosophy Department, this degree is aimed at promoting inter-disciplinary and inter-faculty collaboration in offering students highly specialised degrees with a view to preparing them for work-readiness and equipping them with the required skills to operate in the corporate world.

In 2017, the University Senate approved the establishment of an honours degree in PPE and Prof Ruttkamp-Bloem commenced the process of developing a master's degree programme in PPE.

### New directions

The period under review also saw a number of new directions explored and expanding the Department of Philosophy. A decades-long focus on Continental (Europe) philosophy was slowly making place for new development and directions in African continental and global philosophical trends. Analytical and African Philosophy now ranked with Continental Philosophy to complete the three broad philosophical traditions studied in the Department. Prof Praeg's arrival sparked a further period of transformation in the Department's traditional offerings and turned attention to African Philosophy and ideas, issues and debates in decolonisation, coloniality and Africanisation. Prof Praeg brought with him the UKZN Press *Thinking Africa* book series.

Another new direction in the Department came with Prof Ruttkamp-Bloem, who as a specialist in the philosophy of science and ethics of artificial intelligence (AI), had been a researcher at the Centre for AI Research (CAIR) since 2014. The CAIR is a distributed South African research network with nine research groups across six universities: UP and the universities of Cape Town (UCT), Stellenbosch (SU), KwaZulu-Natal (UKZN), North West (NWU), and Western Cape (UWC). The Centre is funded primarily by the Department of Science and Technology (DST) through the Council for Scientific and Industrial Research (CSIR).

Until 2017, Prof Ruttkamp-Bloem belonged to the Knowledge Representation and Reasoning research group and in 2017 she founded the Ethics of AI research group at the Centre. In 2018, she initiated an *AI for Society* bi-annual symposium series, hosting seminars by researchers from UP and the universities of the Witwatersrand (Wits), Johannesburg (UJ), UCT, and SU, from computer science, philosophy, historical studies, statistics, information science and computer engineering.

## 8. Political Sciences

The period under review saw several changes in the staff structure of the Department of Political Sciences. Prof Maxi (M) Schoeman, who joined the Department in late 2000, remained Head of Department until February 2016 when she took up the position as Deputy Dean: Postgraduate Studies and Research Ethics in the Office of the Dean of Humanities. The departmental administrator, Rina (R) du Toit, who joined the Department in 1996, remained in this position throughout the review period. After the departure of Prof Schoeman, Prof Sandy (S) Africa was appointed as the acting Head of Department until the appointment of Prof Siphamandla (S) Zondi in early 2017.

Several new appointments were made in the Department during this period, among them Prof Lorenzo (L) Fioramonti who subsequently received a Jean Monnet Chair in European Union Studies and who established the Centre for the Study of Governance Innovation (GovInn). Prof Fioramonti took a leave of absence in early 2018 to take up a position as elected member of the Italian Parliament. Prof Laurie (L) Nathan was appointed to the Department in 2011 and established the Centre for Mediation in Africa (CMA). He resigned in 2016 to take up the position as Director of Notre Dame University's Kroc Institute for International Peace Studies. Sithembile (S) Mbetse was appointed as a lecturer in 2013 and was awarded a PhD in International Relations in 2018. Dr Cori (C) Wielenga was appointed in 2017 as a senior lecturer. With the departure of Prof Fioramonti, Dr (CC) Nshimbi was appointed Acting Director of GovInn, assisted by Dr Wielenga as Acting Deputy Director.

From 2017, onwards Safiyya (S) Goga worked at growing a generation of young black academics at South African universities in terms of the New Generation of Academics Programme (nGAP) of the Department of Higher Education

and Training (DHET). Prof Christopher (C) Isike joined the Department in early 2018. Several contract and part-time lecturers joined the Department during the period under review, among them Anthony (A) Bizos, Heather (H) Thuynsma and Ambassador Mdu (M) Lembede, an alumnus of the Department's MA (Diplomatic Studies) programme.

Prof Marié (ME) Muller, whose second term as Dean of the Faculty of Humanities came to an end in early 2008 and who had returned to the Department as a full professor, passed away in March 2013. Prof Hussein (H) Solomon took up a position at the University of the Free State in 2009. Prof Michael (M) Hough, who for three decades served as the Director of the Institute for Strategic Studies in Southern Africa, retired at the end of 2009 and the Institute was restructured into the Institute for Strategic and Political Affairs (ISPA) with Prof Sandy Africa at the helm. Profs Katabaro (K) Miti and Anton (A) du Plessis retired in 2016.

Two new extraordinary professors were appointed: Dr Henning (H) Melber, an NRF B-rated scientist, and Prof 'Funmi (F) Olonisakin, Director of the African Leadership Centre at King's College in London. She was appointed Deputy Vice-Chancellor at King's in 2018. Prof Chris (C) Alden (London School of Economics, UK) remained a research associate of the Department.

Dr Gerhard (FG) Wolmarans, a staff member in the Department, was awarded a PhD in Political Sciences from the University of Johannesburg in 2009. Prof Africa was seconded for a period of one year in 2010 to serve as deputy director general in the Department of State Security, and between 2012 and 2014 was again seconded to the National Treasury as advisor to the Minister of Finance. Prof Schoeman took up fellowships with the Nordic Africa Institute in 2009 and with the Stellenbosch Institute for Advanced Study (STIAS) in 2016. In 2013, Prof Schoeman was awarded the Claude Ake visiting chair at the University of Uppsala, Sweden.

### Jean Monnet Chair in Regional Integration and Governance Studies

Linked to the Department of Political Sciences and GovInn was the Chair awarded to Prof Lorenzo (L) Fioramonti in 2015 by the European Commission. These Chairs are offered to outstanding scholars in the field of regional governance. This was the first time such a position was given to an academic working in Africa. For three consecutive years, the Chair organised international symposia and research activities, and funded young scholars in the fields of regional integration in Africa. The thematic focus was on comparing governance systems in Africa and Europe and on inter-regionalism. The Chair also published a number of papers, including a paper series on regional integration in Southern Africa, and a few books with contributions by leading experts at the international level.

### Centre for Mediation in Africa

The Centre for Mediation in Africa (CMA) was founded by Prof Laurie (L) Nathan in 2011. In the review period, the CMA established two working paper series: *Mediation Arguments* and *Practitioner Notes*. Ten mediation arguments were published that aimed to capture trends in mediation by scholars working in the field. Five practitioner notes were written by some of the leading mediation practitioners in Africa.

Prof Nathan, in his position as Director of the CMA served on numerous high-level bodies, including the steering committee of the UN Academic Advisory Council on Mediation. The CMA hosted public seminars and events with scholars, practitioners and policymakers on cutting-edge issues in the field of peace, conflict and mediation. Invited speakers included the Deputy Director General of the Department of International Relations and Cooperation (DIRCO), among other high-level dignitaries. The Centre trained hundreds of women, men and youth in mediation skills, including a number of training workshops with the United Nations (UN), African Union (AU), Southern African Development Community (SADC) and the East African Community (EAC).

CMA staff also contributed to scholarly debates on peace, conflict and mediation through numerous publications in academic journals and edited volumes. The work of the CMA was made possible during this period by funding from the African Peacebuilding Network, the Belgian government and the Royal Norwegian Embassy.

### Teaching and research

During the period under review, the Department continued its focus on teaching and research. It experienced a steady growth in student numbers, and the demographic profile of students continued to change. By 2018, approximately 80% of students were black and a growing number from the rest of the African continent.

Several new research projects were initiated during this period:

- The Department joined seven international universities (in the UK, Europe and China) with the University of Edinburgh as the lead university in an EU-funded MERCURY project on multilateralism and the EU in the contemporary global order (2009-2012).
- In 2014 the Department received funding under a grant to the University from the Andrew Mellon Foundation to establish a focus area on Peace and Conflict in Africa. Prof Olonisakin served as an expert scholar during the initial phases of the project.
- Through GovInn's research on African migration under the leadership of Dr Chris Nshimbi, a specialisation in migration studies was established.
- Funding from the Belgian government for the period 2011-2014 ensured the development of the CMA and a specialisation in mediation studies, dovetailing with the Department's offering of its specialised master's programmes in Security Studies and Diplomatic Studies.

- Under the leadership of Prof Schoeman and Prof Olonisakin, a joint PhD in Security and Leadership was established between UP and King's College in 2018.

Throughout this period the Department retained its status as one of the top publishing entities in the Faculty of Humanities. It also successfully hosted seven postdoctoral fellows, two of whom (Prof Fioramonti and Dr Wielenga) were appointed as permanent staff members at the conclusion of their fellowships. The Department continued to offer its annual study abroad programme (initiated in the early 2000s) with George Mason University in Virginia (US).

## 9. Psychology

There were several changes in the leadership of the Department of Psychology during the period 2009 to 2018. Prof Maria (MC) Marchetti-Mercer served as Head of Department from 2009 to 2011. She was succeeded by Prof David (DJF) Maree in 2012 who served until 2017. Prof Tharina (T) Guse was appointed in 2018 as the new Head of Department, after a short period during which Prof Claire (C) Wagner served as Acting Head.

Although there were no major structural changes, the Department's renewed focus on increasing research capacity and output resulted in the appointment of extraordinary professors. Five such appointments were made during the review period: Prof Cindy (C) Crusto (Yale University, USA); Prof Oliver (O) Turnbull (Bangor University, Wales); Prof Saths (S) Cooper (International Union of Psychological Science

(IUPsyS); Prof Derek (D) Hook (City University of New York, US); and Prof William (W) Latimer (McAnulty College and Graduate School of Liberal Arts, US).

## Highlights

Notable staff achievements during the review period included recognition received by national and international associations:

- The appointments, in 2015, of Prof Guse and Prof Maree as board members of the Professional Board for Psychology of the Health Professions Council of South Africa (HPCSA).
- Prof Maree's keynote address at the *7th World Conference for Psychotherapy: Psychotherapy meets Africa*, held in Durban from 25 to 29 August 2014.
- Tebogo (TB) Sole's award for her exceptional paper at the Sustainable Built Environment (SASBE) Conference held in Pretoria from 9 to 11 December, 2015. The conference paper, 'Smart fuel choices in urban households: Stories from women in Soshanguve' was co-authored with Prof Wagner. The authors were invited to submit the paper for review and a revised version was published in 2018, 'Understanding domestic fuel use practices in an urban township', *Building Research & Information*, 46(2), 220-230.
- Dr Nicoleen (N) Coetzee's co-authored article, *Kardiovaskulêregesondheidsrisiko onder universiteitstudente in Suid-Afrika*, published in *Suid-Afrikaanse Tydskrif vir Natuurwetenskap en Tegnologie* (ATKV, 2015). She was awarded first prize in the Science category of the ATKV awards for outstanding scientific articles in Afrikaans in 2016.
- Dr Assie (A) Gildenhuys was elected as board member of the International Congress of Group Psychotherapy and Group Process for the period 2012 to 2016.

Notable research projects in the Department during this period included:

- The *Kgolo Mmogo* project, completed in 2009, which was a joint project between Psychology and UP's Faculty of Education, and the Center for International Research on AIDS (CIRA) of Yale University under the leadership of Profs Irma (I) Eloff and Brian (BWC) Forsyth. The project was recognised for excellence in HIV research related to children by the International AIDS Society and the Coalition on Children affected by AIDS. It was based on a randomised clinical trial of an intervention to promote

resilience in young children of HIV positive mothers in South Africa. Prof Maretha (M) Visser was one of the researchers on the project.

- Prof Maree, Prof Visser and Sonja (S) Mostert's project for the Public Protector, 'Public and stakeholder awareness, access, trust, confidence and faith in the Public Protector South Africa' (2012).
- Anne-Gloria (A) Moleko's project, 'Adaptation of the US version of IFCBT-HIVPI to prevent HIV among drug users in South Africa' (2012-2014).

Department-specific research projects included:

- 'The impact of NGO services on the psychological health and coping resources of HIV/AIDS-affected children in South Africa' (2012-2013), which sought to evaluate the impact of Lefika NGO services on the psychological health, coping resources, and school performance of orphans and vulnerable children (OVC) who receive services from the Stinkwater Centre (Hammanskraal, Pretoria).
- The Department took the lead in an interdisciplinary Mellon-funded project on vulnerable children, with the focus on children exposed to violence, and children orphaned and affected by HIV. Several staff members and master's students were involved (2013-2016).

## Programme accreditation

In 2016, the Health Professions Council of South Africa (HPCSA) reaccredited three professional programmes in the Department, namely the MA (Clinical Psychology), MA (Counselling Psychology), and MA (Research Psychology).

## SCHOOL OF THE ARTS

In 2018, the Arts cluster in the Faculty was restructured into a School of the Arts, an amalgamation of the departments of Music, Drama and Visual Arts, with Prof Alexander (A) Johnson as Head of School.

## 10. Drama

Prof Marié-Heleen (M-H) Coetzee, appointed as the Head of the Drama Department in 2009, remained in this leadership position until the end of the review period. Long-time academic staff members Abri (A) le Roux and Dr Estelle (E) Zeeman retired in this period, as well as Yvonne (Y) Rabie, the departmental administrator.



Mama Mudu's Children, a play staged by UP that formed part of the Ubuntu project

Dr Chris (CW) Broodryk was promoted to the academic staff complement and later to senior lecturer. Extraordinary professor and NRF C3-rated researcher, Prof Marth (M) Munro continued her involvement in the Department's academic and research programmes. Three new lecturers joined the Department: Bailey (B) Snyman (Standard Bank Young Artist for Dance in 2012), Morné (M) Steyn and Dr Myer (M) Taub.

Prof Coetzee initiated the reconfiguration of the Arts Cluster into the School of Arts, which was concluded in 2018, bringing together under one umbrella the departments of Drama, Visual Arts and Music.

## Curriculum change and research

The undergraduate academic programme was reconfigured into a BDram degree (phased in from 2016) to better align with changes in the performing arts landscape, to create a greater interface with industry, and to enhance epistemic diversity in the curriculum. The BDram not only focuses on discipline-specific skills, but also opens up ways in which drama and performance can be applied as modes of inquiry and ways of generating new knowledge.

Teaching was undertaken by a small complement of permanent staff and part-time experts from the professional performing arts sector. The Department's excellent throughput rate demonstrated the success of the student selection process, and the effectiveness of the Department's approach to teaching and learning. The UP Teaching and Learning award won by Rian (R) Terblanche and Johannes (J) Visser in 2010, was further testimony to the Department's commitment to excellence.

At postgraduate levels, the MA and DPhil programmes were streamlined to include an MA and a PhD in Drama, and in Drama and Film Studies. The Department significantly increased its postgraduate output, with advanced postgraduate students presenting their work at local and international conferences and contributing to journal articles.

The Department's research outputs increased with staff members publishing book chapters, articles in academic journals and popular journals, co-editing three books and editing two special editions of the *South African Theatre Journal* (2010, 2018). Staff members also received creative output awards from the UP Creative Awards Committee.

During this period, the Department co-presented with the University of the Witwatersrand (Wits) the third and fourth Africa Research Conference, *Drama for Life*. In 2012, the Department co-presented and hosted the fifth Africa Research Conference, followed by the *Body-Space-Emergence* conference in 2014. In 2016, the Arts cluster, under the chairpersonship of Prof Coetzee, hosted its first colloquium with a focus on embodied knowledges and pedagogies in the arts in support of one of the cluster's research focus areas.

### Highlights of engagement

The Department's applied drama and theatre modules, offered from second year to honours, were modules specifically aimed at community engagement and working with issues of social justice. To this end, students were involved in a range of community-based projects that dealt with issues communities typically face. The practical components of these modules were presented, among others, in Matsulu, Mamelodi, Eersterust, Villieria, Brooklyn and the Merafong municipal area.

There were also several sponsored initiatives, which included a year-long partnership with the South African National Parks (SANParks), a three-year partnership with Anglo-Gold Ashanti and the Aardklop Arts Festival, a three-year project funded by the National Lottery, and a 10-year partnership with the South

African Police Service (SAPS) Villieria and the Tshwane Metro Police.

The Department initiated several international partnerships during the review period, which manifested in extra-curricular workshops and training modules in Lessac Kinesensics (2013, 2015 and 2017), and Laban/Bartenieff Movement Studies (2014, 2016, 2018) that were respectively endorsed by the Lessac Research and Training Institute and Laban/Bartenieff Movement Studies in New York (US).

These workshops and training modules were the first of their kind in sub-Saharan Africa. As the work had interdisciplinary and transdisciplinary applications, attendees came from several countries and a range of professional backgrounds, from theatre, to therapy and teaching. In 2017, the Department entered into a formal memorandum of understanding with the Laban/Bartenieff Institute of Movement Studies. This made possible the offering of local training for the introductory Laban/Bartenieff Movement Studies module, as well as four of the five modules that make up the international certification in movement analysis (CMA). A number of international guest artists and lecturers engaged with staff and students.

### Productions and awards

During the review period, the Department staged between 10 to 12 public productions of varying size per year, including exams that took the form of public performances. The Department's creative work received two Standard Bank Ovation awards, in 2013 and 2015 respectively. Creative work (student-authored and authored by lecturers with students as performers) was presented on platforms including the National Arts Festival (student, fringe and main festivals), the JOMBA! Dance Festival (2011), the Aardklop Arts Festival (2011), the Presidency (2012), the Smithfield Arts Festival (2013), the Vavasati International Women's Festival (2015), the Market Theatre (2017), the Brooklyn Theatre (2017), and the Breytenbach Theatre (2018).

The Department collaborated with universities in South Africa, which included a dance work co-produced with the Tshwane University of Technology's (TUT) Department of Dance and Musical Theatre, and a theatre production with the Durban University of Technology (DUT) and the University of KwaZulu-Natal (UKZN) Drama Departments.

In 2016, the Department partnered with community artists from Mamelodi in its production of *uMabatha*. It also presented two productions in association with the

US Embassy in 2013, and the Embassy of Spain in 2017. Academic staff, as well as local and international practitioners contributed to these productions.

A further notable achievement was the Department's annual hosting of the Kopanong Student Arts Festival that offered a platform for any student or young artist to create original work in any language and genre. The focus is on facilitating the transition from the educational arena to an economically active professional environment. During the review period, the festival saw productions from as far as Mozambique, and in South Africa, KwaZulu-Natal.

## 11. Music

Prof Wim (W) Viljoen was Head of the Department of Music from 2008 to 2015 and, in 2016, was succeeded by Prof Alexander (AF) Johnson, who was appointed in this leadership position. In 2013, the Department became part of the Arts Cluster in the Faculty of Humanities (Drama, Music and Visual Arts).

The music technology programme underwent significant revision and growth in the period 2017 to 2018, including Dr Miles (MS) Warrington's full-time employment to oversee the development of the programme. A new module, MCS 200, was introduced to address gaps in the sequence of electives. Also of significance was the introduction of electroacoustic composition to the content of the composition elective streams in 2018 and the establishment of an electroacoustic music recording, production, and composing studio.

The appointment of Prof Mageshen (M) Naidoo (Coordinator of Jazz Studies) in November 2015 made possible the offering of a fully-fledged jazz studies stream from 2016 onwards. In addition, students in the BMus (Performing Art) programme could elect to take jazz modules leading to a major in jazz studies. In 2016 UP celebrated the launch of jazz studies in the Department of Music at the Tshwane JazzUP donor event, hosted by the Vice-Chancellor and Principal, Prof Cheryl de la Rey. A year later, in October 2017, the Faculty hosted the first UP Jazz Symposium, *Freedom in Jazz*.

### Highlights

With world-class composers, musicians, and conductors, the Department of Music had several notable achievements during the period under review. Some of the many staff highlights are listed here:

- In 2014, Prof Johnson's *Colour-keys for Clarinet in B flat* was prescribed for the First Unisa International Flute and Clarinet Competition, and in 2018, his *Vocalise Africa* for the Unisa International Classical Singing Competition. His orchestral works have been performed by a number of esteemed orchestras, including the Lucerne Festival Strings, Zürich Camerata Orchestra, Niš Philharmonic Orchestra, and South Africa's National Symphony Orchestra.
- Prof Naidoo was elected president of the South African Association for Jazz Education (SAJE) from 2016–2018. He was appointed to a second term as President of SAJE from 2018. Prof Naidoo performed at several national and international events, including a featured concert at the Amersfoort International Jazz Festival in The Netherlands (2016), the Kreol Festival in Mahe, Seychelles (2018), and the South African Jazz Songbook with the Artvark Saxophone Quartet in The Netherlands and South Africa (2019).
- Dr Hanli (H) Stapela started teaching part-time at UP in 2008, and in 2012 she was appointed full-time as coordinator of the Classical Voice and Opera Studies programme. She recorded several well-received CDs during this period and performed at the Lithuanian Academy of Music and Theatre, Vilnius, Lithuania, in 2018.
- Prof Theo (T) van Wyk gave several organ recitals during his United States tour in 2016, including at the University of North Texas, Denton, and in New York City at the Grace Church, Manhattan, and at St Thomas Church, Fifth Avenue. In 2018 he performed at the Westminster Abbey in London.
- Dr Michael (MJ) Barrett's choirs won numerous national and international awards, as well as choral competitions, including the Grand Prix of Nations (Latvia 2017), the 8th World Choir Games (Latvia 2014), the St Petersburg Choral Competition (Russia 2013), the Llangollen International Musical Eisteddfod (Wales 2012), Krakow International Advent Choral Competition (Poland 2012), Europe and its Songs (Spain 2010), and the International Youth Music Festival (Slovakia 2010).
- The Tuks Camerata celebrated its 50th anniversary in 2018 and received numerous national and international accolades over the years. In 2017 the choir was invited to perform at the World Choral Symposium in Barcelona, Spain. The choir also released three CDs, all nominated for the South African Music Award (SAMA).



- Dr Ben (B) Schoeman won several awards during this period, including the International League Music Competition, London (2009), the Standard Bank Young Artist Award for Music (2011), and the contemporary music prize at the Cleveland International Piano Competition, US (2013).
- Dr Carol (C) Lotter and Dr Andeline (A) Dos Santos won the bid at the World Congress of Music Therapy in Tsukuba, Japan, to host the 2020 World Congress, in Africa, at the University of Pretoria (2017).

There were several important student achievements during this period: Misha (M) Melck won the UNISA Licentiate Overseas Scholarship Competition (2012), which allowed her to travel to London, Austria, Germany, and Switzerland for masterclasses. Willem (WP) de Beer was the main prize winner and the joint winner of the Piano Category at UNISA's 120th Anniversary Bursary Concert (2014), and a finalist in the Stellenbosch International Chamber Music Festival Bursary Competition (2015). Megan (M) Kahts appeared in various operatic roles in Europe, including performing with the Sarajevo Philharmonic Orchestra in 2017. Ammiel (A) Bushakevitz was named the Edison Fellow of the British Library, London, in 2014.

## Research

In addition to the research interests of individual members of staff, the Department focused on two research projects. The first was the Advancing Interdisciplinary Research into Singing (AIRS) project, a major collaborative research initiative based at the University of Prince Edward Island, Canada, which involved over 70 researchers worldwide. There were nine strands, including a global focus for which Prof Caroline (C) van Niekerk was responsible. The second, North-South-South project started in 2004 as a collaboration between the University of Jyväskylä and the University of Pretoria, organised by the Centre for International Mobility (CIMO) in Finland. In 2018, and due to reduced financial support from the Finnish government, the University of Pretoria and the University of Jyväskylä signed a new agreement that replaced the former, and that would promote the exchange of staff and students, participation in seminars and workshops, and the joint supervision of master's and doctoral students, as well as cooperative research projects.

## 12. Visual Arts

Prof Jeanne (J) van Eeden served as Head of the Department of Visual Arts from March 2007 until 2015. Prof Raimi (R) Gbadamosi served in this leadership position in 2016. Prof Amanda (A) du Preez acted as Head of the Department in 2017 and 2018.

An important transition at the end of the review period was the amalgamation of three departments into the new School of the Arts, namely the departments of Visual Arts, Music and Drama. Prof Lize (L) Kriel was appointed as chair of the Visual Arts programmes in 2019, reporting to the new Head of the School of Arts, Prof Alexander (AF) Johnson.

Programme and curriculum changes during the review period included the consolidation of the disciplines Art History and Visual Communication into a new major, Visual Culture Studies, in 2011. Master's and doctoral programmes were introduced in Digital Culture and Media in 2018. The Department looked forward to the completion of the Javett-UP Art Centre, which would house a student art gallery.

Creative outputs in art and design, which had enjoyed official recognition at UP since 2003, could, from 2018, also be submitted to the Department of Higher Education and Training (DHET) as subsidised research outputs.

### Highlights

There were several notable achievements during the review period, some of which are listed below. Academic staff continued to be represented on the boards of national and international subject associations and academic journals, and were adjudicators of art and design competitions. They were also regularly invited as visiting scholars to international institutions. In 2014, 2015 and 2016 respectively, Andrew W Mellon distinguished visiting scholars Kris van 't Hof (at the time from Artesis Hogeschool Antwerpen, Belgium) was hosted by Prof Elfriede (E) Dreyer; Audrey (AG) Bennett (at the time from Rensselaer Polytechnic Institute, Troy, New York) was hosted by Dr Fatima (F) Cassim in Information Design; and Prof Gillian (G) Rose (at the time from The Open University, Milton Keynes, UK) by Dr Jenni (J) Lauwrens in Visual Studies.

Three professors achieved NRF ratings during this period, namely: Prof Van Eeden, C2 (2011), Prof Kriel, C2 (2012), and Prof Du Preez, C2 (2013).

The Department's staff were engaged in several research projects in this period:

- The Visual Technologies project, sponsored by the Andrew Mellon Foundation, ran from 2013 to 2015, coordinated by Prof Van Eeden.
- In 2014, the NRF Thuthuka grants were awarded to Nicola (N) Grobler for her doctoral project, 'The Visitor Centre: Artistic reconfigurations of multispecies interactions in an urban environment', and to Fatima Cassim for her doctoral research on Design Activism.
- The NRF-sponsored Digital Humanities project from 2016 to 2018 was managed by Prof Du Preez.
- Prof Kriel began a National Institute for the Humanities and Social Sciences (NIHSS) sponsored project on 'Mission archives as repositories of African knowledge' in 2017.

The Department increased its national inter-university collaborations with Fine Art students at UP working with students at the University of Cape Town (UCT) and the Tshwane University of Technology (TUT). International partnerships focused, in particular, on Africa-Africa and Africa-Europe collaboration.

Publication highlights during the review period included:

- A monograph by Prof Amanda du Preez: *Gendered Bodies and New Technologies. Rethinking Embodiment in a Cyber-Era* (Cambridge Scholars, 2009).
- A monograph by Dr Duncan Reyburn: *Seeing Things as They Are: GK Chesterton and the Drama of Meaning* (Cascade, 2016).
- Book chapters contributed by Prof Jeanne van Eeden and Jacques Lange to *Designing Worlds. National Design Histories in an Age of Globalization*, edited by Kjetil Fallan and Grace Lees-Maffei (Berghahn, 2016).
- Prof Jeanne van Eeden served as editor, until 2018, of the journal *Image & Text*, an accredited open access journal, and was followed by Dr Rory du Plessis and Dr Fatima Cassim as editors of the journal.

### Exhibitions and awards

The Department also hosted several exhibitions during this review period:

- In 2013, *Metromusings, Hidden Urban Histories* and *Nomad Bodies*.





- In 2014, *Visual Encounters* and in the next two years *Soiled* (2015) and *Tempo* (2016).
- Facilitated by Information Design alumnus Jacques Lange, The Mandela Poster Project Collective, in partnership with the University of Pretoria, exhibited 95 posters by designers from around the globe in July 2013, which celebrate the life of Nelson Rolihlahla Mandela.

The achievements of students who were finalists and winners in some of the major South African art competitions were a source of pride to the Department. In 2014, for example, Fine Art student Liberty Battson won the prestigious Absa L'Atelier Competition.

Guest lecturer in Fine Art, Diane (D) Victor, exhibited internationally, with works purchased by, among others, the Museum of Modern Art (New York) and the Victoria and Albert Museum (London).

In 2012–2013, Dr Cassim was affiliated with Harvard University's Graduate School of Arts and Sciences on a Harvard South Africa fellowship; and in 2014 Dr du Plessis was awarded a pre-doctoral fellowship at the Max Planck Institute for the History of Science in Berlin. Prof Kriel's Alexander von Humboldt Foundation Fellowship was renewed in 2013-2014 for an affiliation to the Humboldt-University in Berlin.

### 13. Sociology

The Department of Sociology underwent several changes in the period 2009 to 2018. When Prof Janis (J) Grobbelaar retired in 2014, she had been at the helm of the Department since 2001. There were a number of acting heads of department before the appointment of Prof Debby (D) Bonnin as the new Head of Department in July 2014. Prof Sakhela (S) Buhlungu was Acting Head in 2012 and for a period in 2013, and Dr Charles (C) Puttergill from November 2013 to June 2014.

The Department experienced a high turnover of staff during this period. In 2009, there were eight full-time academic staff and one administrator. By 2018, all with the exception of one member of the academic staff had either retired or left the department. However, the change in staff also provided the opportunity to introduce new curriculum content and, by late 2018, to consider the complete renewal of undergraduate and postgraduate programmes.

#### Curriculum change

There were important changes to the curriculum during the review period; in summary:

In 2013, Humboldt-Universität zu Berlin, Germany, approached the Sociology Department to be a South African partner in the MA Global Studies Programme (GSP), focusing on postgraduate student exchange. The programme is housed in the Department of Sociology and, between 2014 and 2018, 39 students had come to UP from 21 countries across the world.

At the level of undergraduate modules, a tutor programme was launched in 2011 to assist first-year students, which contributed to an increased pass rate in first-year modules. In 2014 a foundation module was introduced that focused on key themes and historical moments in the development of apartheid South Africa.

An ongoing focus remained the introduction of new scholars from the global South and Africa, in particular.

#### Research highlights

A number of research projects were undertaken by the Department during the review period, with highlights including:

- A baseline survey on the needs and perceptions of the youth (2009). The Department of Sociology together with the Department of Social Work conducted a survey in collaboration with the Gauteng Department of Education (Tshwane South District) to collect baseline information on the youth.
- Kumba Iron Ore Project (2013-2014). This project was commissioned by Kumba Iron Ore and managed by Prof Buhlungu and Prof Andries (A) Bezuidenhout. Several postgraduate students participated in the fieldwork and were able to use the data collected towards their dissertations.

- 'Taking democracy seriously' workers' survey (2014). The aim of the project was to assess workers' perceptions of trade union democracy and how that was extended to broader political democracy in South Africa. This formed part of a longitudinal study that takes place every five years prior to the national election.
- Audit of health and safety structures of the National Union of Mineworkers (NUM) (2015). Staff and students from the Department conducted an audit of the health and safety structures of NUM. The project was led by Prof Bezuidenhout.
- Family cohesion, values and well-being project (2015-2017). Prof Zitha (Z) Mokomane collaborated with the Human Sciences Research Council (HSRC) on this project, which entailed the analysis of the family module of the 2012 South African Social Attitudes Survey.
- The corporate family responsibility in South Africa project (2016-2017). In collaboration with the International Centre for Work and Life at the IESE Business School (Barcelona, Spain), Prof Mokomane coordinated the implementation of the International Family-Responsible Employer Index (IFREI) in South Africa.

In addition to the research output of individual members of staff, the Department contributed substantially to two publications:

The first, *Development, Inequality and Social Justice in Southern Africa*, was published in the journal *Development Southern Africa* in 2011. The special issue was edited by Prof Janis Grobbelaar and Prof Kammila (K) Naidoo. A number of the articles were authored by staff, postgraduate students and a postdoctoral fellow in the Department.

The second, edited by Prof Andries Bezuidenhout and Prof Malehoko (M) Tshoedi, *Beyond COSATU: Mapping the Rupture in South Africa's Labour Landscape*, was published by Wits University Press in 2017. A number of postgraduate students were co-authors of some of the chapters in this edited volume.

Three national and international conferences were hosted by the Department:

- *XVII Annual Congress of the South African Sociological Association* (10-13 July 2011), hosted in collaboration with the Institute for Women's and Gender Studies (IWGS) at UP.
- *The International Symposium on Food Studies: Transnational Conversations*, University of Pretoria (22-23 July 2016).

The symposium was jointly organised by the Dean of Humanities, Prof Vasu (V) Reddy, staff in Sociology, and colleagues at the University of the Western Cape.

- A *Southern African Dialogue on the Professions and Professional Work*, University of Pretoria (18-19 September 2017). The colloquium was organised by Prof Bonnin in collaboration with a colleague from the University of KwaZulu-Natal.

### Notable individual achievements

Notable individual achievements during this period included:

- Two members of staff received NRF ratings, Prof Mokomane, a C2 rating (2018), and Prof Reddy, a B3 rating (2016).
- Prof Bonnin was elected to the Board of the International Sociological Association's Research Committee 52 (Sociology of Professions) in 2014, and as vice-president in 2016.
- Prof Mokomane was appointed as a member of the International Advisory Board of the India-based Service and Research Institute on Family and Children (SERFAC) (2015); and in 2016, to the International Federation for Family Development, Spain (2016).
- Dr Irma (I) du Plessis served as president of the South African Sociological Association from 2013 to 2015.

The Department's students also had notable achievements during this period: master's students Saint-Jose (Sj) Inaka and Mukai (M) Jaison were joint winners of the South African Sociological Association's student essay competition in 2015. Vangile (V) Bingma was awarded a fellowship at the University of Michigan (US) by the African Presidential Scholars Programme (2015-2016). Doctoral student John (J) Mashayamombe was selected to participate in the International Sociological Association PhD Laboratory held in Poland in September 2017.

## 14. Social Work and Criminology

Prof Antoinette (A) Lombard was the Head of the Department of Social Work and Criminology during the period under review. While there were no major structural changes to the Department, six members of staff retired in this period, which presented the opportunity to expand the diversity profile of staff. Adding to the academic profile were exchange programmes with the Arveelde University of Applied

Sciences, Ghent and the Management Centre in Innsbruck, Austria.

In addition to teaching and curriculum renewal, research remained an important focus and so too the Department's community engagement projects.

### Highlights of achievement

Four professors achieved NRF ratings during this period, which was testimony to the Department's increased research capacity: Prof Lombard C2 (2010) and C1 (2016), Prof Christiaan (C) Bezuidenhout C3 (2017), Prof Francois (F) Steyn C3 (2018), and Prof Lourie (LS) Terblanche C3 (2018).

Notable staff achievements during this period included the following:

Prof Bezuidenhout served as the president of the Criminological Society of Africa (CRIMSA) for the period 2015 to 2018.

In 2011 Prof Stephan (LS) Geyer was awarded the Young Up-and-Coming Academic of the Year by the Association of South African Social Work Education Institutions (ASASWEI). Prof Lombard was the second runner up for the Distinguished Women in Science Award (WISA) in the category Humanities and Social Sciences by the Minister of Science and Technology in 2015; she received the ASASWEI Distinguished Educator of the Year award in 2017.

Prof Reineth (CE) Prinsloo was awarded the International Association of Social Work with Groups (IASWG) International Honouree Lifetime Award in 2018. In the same year Prof Lourie (LS) Terblanche received special recognition from the Employee Assistance Professionals Association, South Africa branch for his book, *The Development of Employee Assistance Programmes in South Africa and the History of the EAPA-SA*.

Some of the highlights included:

- The collaborative Fordham University Ubuntu Study Abroad programme, launched in collaboration with UP in 2012, under the leadership of Prof Lombard.
- In the period 2011 to 2014, Prof Lombard facilitated the research proposal development of the PROSOWO<sup>1</sup> project, working with Carinthia University of Applied Sciences (Austria), Makerere University (Uganda), University of Nairobi (Kenya), the Institute of Social Work (Tanzania), and the National University of Rwanda (Rwanda). Prof Lombard subsequently evaluated all book chapters and

assisted in finalising the publication by H Spitzer, JM Twikirize and GG Wairire (eds.), *Professional Social Work in East Africa. Towards social development, poverty reduction and gender equality* (Kampala: Fountain Publishers, 2014).

- Prof Bezuidenhout led two research projects: in 2010-2015 a project on human trafficking, with Prof Mark (M) Lanier at the Virtual Centre for Epidemiological Criminology (VCEC), University of Alabama (US); and in 2013 a project on rhino poaching in collaboration with the Department of Safety and Security at the Council for Scientific and Industrial Research (CSIR).

Prof Geyer, Dr Liana (MP) le Roux, and Dr Herna (H) Hall were engaged in a three-year study on internet use among students at a South African tertiary institution (2016-2019). Prof Steyn undertook a longitudinal assessment of students' perceptions about crime and criminality (2010-2014), followed by an evaluation of the programmes of the non-profit organisation, Camp Sizanani Life Skills in 2017-2018. Dr Le Roux conducted a research project in 2017 for Johannesburg Child Welfare as motivation for continued funding for a project on volunteer 'grannies' for young children in residential care.

There were also notable student achievements:

- In 2017, Peggie Chiwara received two scholarships, respectively from the National Institute for the Humanities and Social Sciences (NIHSS) and Canon Collins, as well as a UP bursary for her comparative doctoral study on the environmental and community sustainability of informal settlement communities in Namibia and South Africa.
- In 2016, Corlie Giliomee (Van der Berg) received the African Mobility Pathways grant and UP Mellon Foundation funding for her doctoral study on exploring human rights education at schools of social work in Southern and East Africa.
- Dr Pamhadzayi Berejena Mbongera obtained her PhD at UP in 2015 and was the first postdoctoral fellow appointed in the Department of Social Work and Criminology for the period 2016 to 2017.
- Dr Ilse Aucamp obtained her PhD in 2015; notably her doctoral research brought together the social and natural sciences in the assessment of social impact as a tool for social development in South Africa. An article published in *Impact Assessment and Project Appraisal* (IAPA) in 2018 won the IAPA best paper award.

### Curriculum change

In addition to ongoing curriculum renewal that remained a central focus for the Department the following changes were made during the review period:

- A module was added to the Criminology honours programme, KRM 781 (Research Report) in order to strengthen students' research foundation.
- In 2016, the name of the MSW Play Therapy programme was changed to MSW Play-based Intervention.
- From 2018, there was a moratorium placed on the intake of the MSW Employee Assistance Programme (EAP) and the MSocSci Employee Assistance Programme (EAP) pending the outcome of an external review. The last intake for EAP was in 2017. However, the EAP programme continued through CE@UP in a range of beginner to advanced short courses, offered in conjunction with other national organisations. It has remained on offer as a research-based focus in an MSW or DPhil study in the Department of Social Work and Criminology.

## 15. Speech-Language Pathology and Audiology

At the start of the review period, Prof Maggi (ME) Soer was the Acting Head of the Department of Communication Pathology (2009-2010), before the appointment of Prof Bart (BM) Vinck as the new Head of the Department in 2011. Prof Vinck served in this leadership position until 2017. Prof Jeannie (J) van der Linde first served as the Acting Head (since 2017) until her appointment as Head of Department in 2019.

In 2014, the name of the Department changed from Communication Pathology to Speech-Language Pathology and Audiology.

### Curriculum restructuring

Since 2009, the Department offered two programmes instead of a single dual programme in order to meet the academic and clinical outcomes of the two professions: Speech-Language Pathology, and Audiology. This restructuring of the degree programmes was also in line with local and international trends.

<sup>1</sup> A project aimed at professionalising social work in East Africa.

In 2016, the degree names B.Communication Pathology in Audiology and B.Communication Pathology in Speech-Language Pathology changed respectively to BA (Audiology) and BA (Speech-Language Pathology).

A further restructuring of the curricula took place in 2017, to align the BA in Audiology (AUD) and BA in Speech-Language Pathology (SLP) programmes to UP's strategy to strengthen the enquiry-led undergraduate programmes, as well as to conform to the professional requirements of the Health Professions Council of South Africa (HPCSA). The restructuring was based on a curriculum mapping exercise undertaken in 2017, benchmarked against the minimum requirements of the HPCSA and international best practice. The revised curricula, approved by Senate in 2018, were developed to be contextually relevant and included interdisciplinary learning as well as a strong research focus.

Some modules in Communication Pathology and Speech Sciences were discontinued and replaced with interdisciplinary community engagement modules (e.g., Integrated Health Leadership, IHL). Further, a year-long research module was introduced in the third year of study, which would be offered by the School of Healthcare Sciences (RHC 300).

### Highlights of achievements

There were several notable staff achievements during the review period:

- Prof Vinck received an NRF B2 rating in 2018. His research on the effectiveness of hearing protectors led to the adoption of a new set of regulations by the Belgian government to enforce quality control on all hearing protectors sold.
- Prof Vinck and Dr Barbara (BM) Heinze secured a R3 million grant from the Oticon Foundation for a state-of-the-art diagnostic and research auditory-vestibular laboratory in 2015.
- Prof De Wet (DW) Swanepoel received an NRF B2 rating in 2016. He was also the recipient of several awards, including the UP Exceptional Young Researchers Award in 2013, and the NSTF/BHP Billiton Innovation Award in the same year.

Prof Swanepoel was the lead inventor of hearScreen™, an innovation that turns an ordinary smartphone into an easy-to-use and cost-effective solution for screening children and adults for hearing loss. In 2016, he received the British

Research Association silver medal for original research by a scientist under 40 years. The medal is one of the highest awards for original scientific research in South Africa. In 2018 he was elected president of the International Society of Audiology. In the same year he was awarded a Newton Scholarship and became the editor-in-chief of the *International Journal of Audiology*.

Prof Van der Linde was a PhD fellow of the multidisciplinary research project on vulnerable children funded by the Andrew Mellon Foundation after completing her PhD in 2015. Dr Faheema (F) Mahomed-Asmail was awarded the Women Emerging: Researcher of the Year in the Faculty of Humanities in 2017 and the Emerging Researcher Award. Prof Anita (A) van der Merwe launched the website on the speech motor learning approach to treating apraxia of speech (<http://www.apraxia-anitavandermerwe.co.za>).

With respect to student highlights, the Department saw the unusual development of four sisters all graduating within a matter of five years. The four sisters, Tamaryn, Meghan, and twins Caitlin and Melissa Pike, all completed their bachelor degrees and subsequently their master's degrees between 2012 and 2017.

## 16. UP Arts

UP Arts in the Faculty of Humanities was initially established as a university-wide entity with the aim to centralise the management and logistics of cultural, performing, musical and visual arts activities on all campuses of the University of Pretoria. First named Arts@UP when it was founded in 2008, the Department was subsequently renamed the Department of UP Arts, and Dr Masitha (M) Hoeane was appointed as Director of the Department in 2009.

There were several leadership and structural changes to the department between 2009 and 2018. Dr Hoeane left the University at the end of April 2013, and Prof Alex (AE) Duffey, previously the Chief Curator of the Van Tilburg Collection, was appointed in an acting capacity after his retirement in 2012. Gerard (GC) de Kamper, then Chief Curator of the UP Art Collection, was appointed interim Director of the Department from September 2013 to February 2015 with the mandate to integrate UP Arts from an independent support service department to a more academic department under the Faculty of Humanities. In March 2015, Prof Theo (TJ) van Wyk was appointed as the new Head of Department, a position he held until March 2018, when the Department of UP Arts along with the Departments of Music, Drama and Visual Arts



were amalgamated under the newly established School of the Arts. Leading up to the end of 2018 — and before the establishment of the School of the Arts — UP Arts comprised three units: Museums and Collections, Music Ensembles and Production Logistics. The staff complement included 24 full-time staff and a further 10 contract and affiliated staff.

### Museums and Collections

Until 2018, the Museums and Collections Unit had 56 museum collections across its campuses with UP Arts being directly responsible for the management and conservation of 28 collections, and indirectly responsible for the remainder. The museums always had a strong focus on the importance of the care and conservation of its collections, with some of the Mapungubwe gold first conserved by the British Museum in 2003. By 2009, however, the UP museums had opened a dedicated conservation space within the Old Arts Building and created a post of museum objects conservator.

This was, at the time, a unique facility at a tertiary institution in South Africa. These in-house services allowed for the improved care of collections, and the preparation of internal and loaned objects for exhibition. Together with the management and conservation of collections, the Unit was also responsible for three permanent UP museums on the Hatfield Campus, the museums housed in the Old Merensky Building and the Old Arts Building, as well as the Van Wouw House Museum that was amalgamated with the Edoardo Villa Museum in 2010.

Collections ranged from cultural, numismatics (coins, medals, gold, etc.), art, textiles, archival, archaeological, historical, natural specimens and ethnographic materials and included artworks, graphics, paintings, sculptures, ceramics, figurines, masks, furniture, carpets, print media, maquettes, artefacts, documents and photographic archives. Each collection required its *own* specialist on the basis of the collections' materials.

The UP Museums grew and continuously received new acquisitions, with about 600 new items acquired between 2009 to 2018, including important donations such as the Mike Edwards Collection (sculptures by Edwards, 2008); the Christo Coetzee Estate (furniture and artworks, 2010); the Welman Collection (South African Ceramics, 2010); the Rita van der Walt Collection (Zulu Artifacts, 2012); and the Giraud Collection (South American Artifacts, 2014). These collections are extremely unique and valuable and hold over 250 000 objects that have been accumulated through donations, bequests, fieldwork, gifts and acquisitions over a century.

Collectively, they are insured for approximately R500 million.

Four of the permanent staff in the review period 2009 to 2018 were researchers and scholars, who published four books and several catalogues with accompanying exhibitions on South African artists in the UP Collections. These included Bettie Cilliers-Barnard (2009), Anton van Wouw (2010), Fanie Eloff (2011), Christo Coetzee (2011), Edoardo Villa (2012), as well as their South African Ceramics (2016) and Eastern and Western Ceramics (2016). Their services were also used on an inter-departmental platform to teach practical components and modules in particular academic departments and faculties.

The core function of this Unit remained museum and collections management and conservation, including both preventative and interventive care of objects. The emphasis on conservation in the UP museums is highlighted by a museum publication, *Staples and Glue: a glimpse into heritage conservation at the University of Pretoria Museums 2008-2018*, and a number of high-profile conservation projects funded by the National Lotteries Commission of South Africa and the US Ambassador's Fund for Cultural Preservation. This emphasis on conservation also carried through academically into the revision of the postgraduate diploma in Museum and Heritage Studies (since 2014, known as the BSocSci Honours Heritage, Museum and Preservation Studies) and saw the University of Pretoria hosting the AW Mellon Foundation's 2015 Art Conservation Workshop. This event, in turn, inaugurated the only master's in art and heritage conservation in Sub-Saharan Africa in 2019, namely the MSoc Sci Tangible Heritage Conservation. The development of the master's in conservation was an essential consideration in the concurrent development of the Javett-UP Art Centre as a central node for art, art appreciation and art conservation in the City of Tshwane.

In this period, the Museums Unit comprised five permanent and two contract positions:

- Dr Sian (S) Tiley-Nel | *UP Museums Manager*
- Gerard (GC) de Kamper | *Chief Curator Collections Management*
- Daniel (DR) Mosako | *Curator Sculptural and Art Collections*
- Isabelle (I) McGinn | *Museum Objects Conservator*
- Maurice (M) Shirinda | *Museum Assistant*
- Helma (H) Steenkamp | *Museum and Research Assistant (contract)*
- Nicole (NB) Hoffmann | *Museum Assistant (contract)*

### Music Ensembles Unit

The Music Ensembles Unit oversaw the activities of a total of eight choirs and ensembles, four of which were affiliated with UP Arts and the University, and were minimally funded by the Office of the Head of Department:

- UP Ovuwa Cultural Ensemble
- Tuks Camerata
- University of Pretoria Symphony Orchestra (UPSO)
- University of Pretoria Symphonic Winds (UPSW)
- Onderstepoort Community Choir (OCC)
- UP Brass Band
- Jacaranda Children's Choir (JCC)
- University of Pretoria Youth Choir (UPYC).

This Unit's core function was the management and coordination of all activities of permanent and affiliated choirs and music ensembles. Until 2018, the Unit was made up of four permanent staff positions with the remaining posts being contract or associated with affiliated choir roles.

The Leo Haese Lunch Hour Concerts were also the responsibility of the TUKS Camerata Manager. The TUKS Camerata Conductor lectured in the Department of Music as part of his employment contract and the choir itself served as a training ground for all choral conducting students.

- Pamela (PA) Oosthuizen | *TUKS Camerata Manager*
- Michael (M) Barrett | *TUKS Camerata Conductor*
- Mxolisi (M) Duda | *UP Ovuwa Manager and Artistic Director*
- Zamile (Z) Mzizi | *UP Symphony Orchestra*

Contract & Affiliated Conductors:

- Gcinabanthu (G) Ntshonga | *UP Symphony Orchestra*
- Matheu (M) Kieswetter, Daniel (D) Letsoalo | *UP Brass Band*
- Lhente-Mari (L-M) Pitout | *UP Youth Choir*
- Christo (C) Burger | *Jacaranda Children's Choir*
- Edwin (E) Mitas | *Onderstepoort Community Choir*

### Production Logistics Unit

UP has a broad range of performing arts facilities and theatres. The responsibility of the Production Logistics Unit,

in this review period, was to coordinate and/or oversee all internal and external productions in various theatres across UP campuses.

The Unit fulfilled a support function for a number of departments, in particular the Department of Drama, and did not have a direct link to academic activities. Productions handled by the Unit included graduation ceremonies, UP Open Days, InSync competitions, choir and opera performances, TUKS Rag, and more.

The core function of this team was to coordinate and oversee all production logistics, both internal and external, across UP campuses. Venues and resources were regularly made available to foreign embassies for the hosting of events and activities focused on cultural exchange. Providing high-quality venues and production services played a role in establishing, maintaining and strengthening international relations on behalf of the University.

Until 2018, the Production Logistics Unit consisted of a team of nine staff, ranging from fashion and décor designers to administrative and support staff.

Due to the nature of services required in the theatre and production environment, staff members are often required to work irregular hours. In this review period, vacant posts were used to compensate staff for overtime work.

- Marielle (M) Labuschagne | *Manager*
- Spiro (S) Schoeman | *Workshop Manager*
- Shilongoane (S) Nkoana and Michael (M) Mosomane | *Workshop Carpenter and Assistant*
- Nomzamo (N) Maseko | *Wardrobe Manager*
- Ninkie (N) Mogwang, Aphiwe (A) Ngcethane | *Senior and Junior Seamstresses*
- Harrison (H) Moeketsi | *Masker and Lier Cleaner*
- Lukas (L) Moumakwe | *Workshop Assistant*

### Highlights of achievements

UP Arts has had a distinguished history in the arts which has included world-renowned art and museum collections and curation, productions in the performing arts, and impressive outreach activities.

Through exhibitions, publications and public lectures the UP Museums ensure access and the use of the UP Art Collections for internal and external research, and where

possible, collaborate on research projects as exemplified by the provenance study of the Rabbi painting, attributed to Rembrandt van Rijn with the Rijks Museum in the Netherlands.

The Museums continually improved knowledge of their holdings through collections-based research which translated into contemporary exhibitions, including the refurbishment of the Van Tilburg Museum, which, since 2013 has included a larger and more diverse display of eastern, western and African ceramics. Likewise, the implementation of the curation of the Mapungubwe Collection and the conservation of the collection lead to updated displays of ceramics in the Old Arts Building, as well as a breath-taking exhibition of the Mapungubwe gold artefacts in the Javett-UP Art Centre in 2019. The Letsopa Lotto Expansion Curation Project focused on collaborative research with the Department of Archaeology on the bone tools of Mapungubwe and led to both an exhibition and the publication of a book. The Mapungubwe Archive Preservation Plan (2018), also funded by the US Ambassadors Fund for Cultural Preservation (AFCP), allowed for the Mapungubwe Digitisation Project, making the archives accessible to research while preserving them.

Further notable achievements in this period included securing the collaboration of an international loan agreement of UP artworks and objects with the British Museum in London, exhibited from October 2016 to February 2017; and the purchase and unveiling of the OR Tambo bust in the Faculty of Law Library in 2017.

The expertise of staff was further recognised externally and they were approached to complete large research projects, such as the Oliver Tambo archival inventory project database commissioned by the Ekurhuleni Metropolitan Municipality (2013); the heritage resources audit, mapping and survey of heritage sites with the City of Tshwane (2016/17); and even the redesign and upgrade of the Ratlou heritage sites and museum for the Ratlou Local Municipality (2015). UP Museums also initiated the UP, South African National Parks (SANParks) and South Africa Heritage Resource Agency (SAHRA) tripartite loan agreement in 2018 which covers artefacts loaned to the Mapungubwe Interpretation Centre at the Mapungubwe World Heritage site in Limpopo.

Tuks Camerata had been actively involved in various noteworthy endeavours. In November 2016, the choir produced an award-winning album, *Love + War*. The album garnered critical acclaim for its exceptional musicality and artistic expression. In the same year, Tuks Camerata toured Europe. In 2017, the choir participated in the prestigious

Grand Prix of Nations in Riga (Latvia), and showcased their talent at the 11th World Symposium on Choral Music.

UP Arts demonstrated its commitment to community engagement by establishing the Onderstepoort Community Choir with the Faculty of Veterinary Science in 2017. This initiative aimed to foster a sense of unity and promote the joy of choral singing within the local community. Furthermore, UP Arts played a pivotal role in providing logistical support for the successful execution of the World Choir Games in 2018, ensuring a seamless and memorable experience for participants and attendees.

UP Arts also prioritised international collaborations, exemplified by the establishment of a memorandum of understanding with Tehran University in Iran. This partnership fostered cultural exchange and cooperation in the realm of arts education and collaboration. In addition, the Department worked towards strengthening the collaboration between the University of Pretoria and various music schools through the JazzUP Tshwane Project, promoting musical diversity and excellence.

Recognising the importance of technical infrastructure, UP Arts took steps to modernise the Masker and Lier Theatres, implementing updated structural, technical, and lighting requirements. In addition, UP Arts enhanced the audience experience and facilitated the staging of memorable performances, such as the annual Principal's Concert.

## FACULTY CENTRES AND UNITS

### **Centre for Augmentative and Alternative Communication**

The Centre for Augmentative and Alternative Communication (CAAC) had grown significantly since its inception in 1990. Prof Juan (J) Bornman was appointed as the Director of CAAC in 2010, following a brief period in 2009 as Acting Director. She remained in this leadership position during the review period.

As a research-orientated centre, the focus continued to be on projects that help people with severe disabilities to participate more fully in society. The projects were facilitated and strengthened by many international partnerships, which included:

- Reducing the risk of being a victim of crime in South Africa, with Temple University, US (2009–2012).

- Speech and language delays in children with neurodevelopmental disorders in South Africa; a five-year collaborative project with Georgia State University (US), funded by the US National Institute of Health (NIH) (2013–2018).
- An NIH-funded project which started in 2017, through the Fogarty International Center and National Institute of Deafness and Other Communication Disorders Mobile Health Initiative, US. The focus was on remediating speech and language disorders in the lives of young South African children.
- A Mellon Foundation-funded research project that formed part of the Faculty of Humanities research theme on traumatised children. The focus was on developing a means of communication for children with severe communication disabilities to disclose sexual abuse and acts of crime against them (2015–2016).
- An NRF-funded Thuthuka postdoctoral grant to design and develop augmentative and alternative communication (AAC) systems for persons with non-English and multilingual backgrounds in South Africa (2016–2018).
- A further NRF-funded project focused on the development and piloting of a training programme comprising an augmented input strategy and use of an iPad™ with AAC software on the receptive language abilities of children with little or no functional speech (2016–2018).

The Centre published two books during this review period. The first, *Write to Life* (2016), is a book of poetry, text and images that profiles seven young adults with severe communication disabilities. The second, *AAC Resource Manual* (2nd edition, 2017) covers a spectrum of AAC topics, practical tips and how-to guidelines and was made available as a CD or via an internet link. Both books were published by the Centre.

### **Achievements and awards**

The CAAC received several awards for its research contributions during this period, which included:

- A UP Education Innovation Laureate Award for exemplary innovative teaching at a PhD level (2010).
- A Hamlet Outstanding Achievement Award in recognition of outstanding achievements in the development and upliftment of the quality of life of persons with intellectual disability (2013).
- The Wharton Re-imagine Education Gold Award for the Africa region, bestowed in Philadelphia, US in recognition

of innovative teaching and learning practice for the project, 'Enhancing postgraduate student achievement: From honours to PhD' (2016).

There also were notable staff achievements in the period under review:

Prof Bornman received several accolades culminating, in 2018, in her election as President-Elect for the International Society for Augmentative and Alternative Communication (ISAAC). In the same year Prof Bornman was awarded the UP Exceptional Academic Achiever's Award and 25-year-long service award. In 2018, she also was elected as a member of the Academy of Science of South Africa (ASSAf), and received an award from the *Journal of Communication Disorders* for her outstanding contributions.

Prof Shakila (S) Dada received the Faculty of Humanities Researcher of the Year Award in 2018. Dr Kerstin (KM) Tönsing was appointed chairperson of the ISAAC research committee (2016). Dr Alecia (AE) Samuels was awarded a two-year postdoctoral fellowship at Jonkoping University, Sweden (2015–2016). Refilwe (RE) Morwane received a scholarship from the National Institute for the Humanities and Social Sciences (NIHSS) in association with the South African Humanities Deans' Association (SAHUDA) (2018).

### **Student achievements**

There also were notable student achievements in this period:

- Dr Sadna (S) Balton received an Excellence in Health award from the Health Professions Council of South Africa (HPCSA) in 2011 for her dedication and making a difference in the lives of those with communication challenges.
- Vuledzani (V) Ndanganeni, a BA Honours student, received a scholarship award for postgraduate studies from the Margaret McNamara Memorial Fund (MMMMF), which is administered through the World Bank (2011).
- Louisa (L) Alberts, a former BA Honours (AAC) graduate and a teacher at the Platorand School in Belfast, Mpumalanga, together with Kristin (K) van der Merwe (Rhodes University), translated the English Blissymbolics vocabulary into Afrikaans (2014).
- Dr Liezl (L) Schlebusch (PhD alumna) received the Emerging Researcher Award from the International Society for Autism Research (INSAR) and Autism Speaks (2017).

## Centre for Sexualities, AIDS and Gender

Established in 1999, the Centre for the Study of AIDS (CSA) was the first dedicated centre of its kind at a university in Africa. In January 2015, the Centre was renamed the Centre for Sexualities, AIDS and Gender (CSA&G) to reflect what had become a more diverse focus that reached beyond AIDS to include other areas of research and engagement.

Mary (M) Crewe, the founding Director, remained in this leadership position, apart from a brief period of co-directorship with Pierre (P) Brouard from 2015 to 2017.

CSA&G continued to receive support from a university-wide body, the TUKS AIDS Reference Group (TARG). Chaired by the Dean of Humanities, Prof Vasu (V) Reddy, and previously by Prof Anton (A) Ströh, TARG met at least twice a year. Members were drawn from all faculties, student bodies, support services and key bodies of the University.

In its twenty-year history, the Centre transformed ways in which many young people came to think about sexualities, race, class, gender and HIV/AIDS. Its theory-led courses aimed to develop a critical curiosity about social issues and, in particular, the intersectionality of race, class and gender. Students were trained to question and challenge the *status quo* and standard or taken-for-granted explanations, and to find new ways of addressing problems and understanding how, as students, they could co-create 'imagined futures'.

In addition, by straddling the domains of theory and practice, CSA&G remained uniquely placed to inform policy and programmes at institutional and broader regional and international levels.

### Research highlights

During the review period, CSA&G became a much more research-intensive organisation. To this end, a number of senior academics, notably Profs Christi (C) van der Westhuizen and Catherine (C) Burns, with co-appointments in the Department of Sociology, spent short periods at the Centre to assist with their contributions to research. Later during this period, the employment of Drs Christi (C) Kruger and Tinashe (T) Mawere contributed to the research undertaken by the Centre. Dr Mawere developed a body of gender writing focusing on Zimbabwe, while Dr Kruger took on the development and editing of a gender justice series.<sup>2</sup> Some of the research highlights during the review period included:

- In 2009, a situational analysis was undertaken of women's and girls' access to health care in Botswana, Kenya,

Namibia and Tanzania. Partners in this initiative included the International Centre for Research on Women, the International Community for Women living with HIV/AIDS, the European Parliamentarians for Africa and the Ethical Globalisation Initiative.

- In 2010, a study was commissioned by the Foundation for Professional Development (FPD): 'What can we learn from people living with HIV to improve HIV prevention for HIV positive and HIV negative people?'
- In partnership with the USAID-funded Health Policy Initiative, the Centre developed indicators of stigma and produced a resource pack for creating awareness about stigma and informing stigma mitigation efforts.<sup>3</sup>
- In 2011 to 2012, the Centre was contracted by Concern Kenya to develop and implement an adolescent life skills programme looking at HIV and AIDS, violence and substance abuse.
- In 2016, the Centre was commissioned by the United Nations Population Fund (UNFPA) South Africa to support the South African National AIDS Council (SANAC) in drafting the new National Strategic Plan on HIV, STIs and TB. The Centre offered technical expertise on the social and structural drivers of HIV.
- In 2017, CSA&G completed a comprehensive desktop review of the integration and linkages between sexual and reproductive health and rights and HIV in South Africa for the UNFPA to guide their country engagement for the next five years.
- Also in 2017, the Centre hosted a colloquium on sexualities, *Trans(lations), fictions, fantasies and Id(entities)*, in partnership with the Department of Philosophy; and a book launch, Prof Ulrike (U) Kistner's *Translation of the first edition of Sigmund Freud, Three Essays on the Theory of Sexuality (1905)*, published by Verso.

During the review period, CSA&G published 12 annual and two extraordinary AIDS Reviews focused on topics of national and regional interest. These Reviews have become prescribed texts in a number of university courses globally.

A further area of engagement and contribution was the work of staff serving on many editorial boards and government agencies related to HIV and AIDS research.

While there were many areas of achievement during this period, notable highlights were:

- The Centre hosting, in 2011, of the SAIH's (Norwegian Students' and Academics International Assistance Fund)



50th Anniversary Conference: *Education for Liberation* with delegates from South Africa, Bolivia, Nicaragua, Norway, Zambia and Zimbabwe.

- In 2015, Mary Crewe and Pierre Brouard co-chairing the 3rd International Conference of the Association for the Social Sciences and Humanities in HIV (ASSHH).
- Prof Van der Westhuizen developing the *Doing Difference Differently* online transformation module for students, under the deanship of Prof Duncan.

With the focus in large part on young people and students, the Centre continued during the period under review with projects related to promoting social justice, critical consciousness, inclusive practices, and co-creating university environments that are responsive and transformed by just leaders.

<sup>2</sup> For a list of monographs in this series, see [www.justgender.org](http://www.justgender.org)

<sup>3</sup> See [www.csagup.org](http://www.csagup.org)

## Centre for the Study of Governance Innovation

The Centre for the Study of Governance Innovation (GovInn) was launched in 2013 and, within a couple of years, it established itself as a leading research institution globally in the field of sustainable development, new economic paradigms as well as innovation applied to governance and social problems. Prof Lorenzo (L) Fioramonti was the founding Director, assisted by Dr Mzukisi (M) Qobo who subsequently was appointed as the Head of the School of Governance at the University of the Witwatersrand (Wits).

GovInn received funding from a number of institutional donors and philanthropies, including the European Union, the South African Department of Science and Technology, the Flemish government, the French government, the Volkswagen Foundation, the Belmont Forum, the Italian Ministry of International Affairs, the German Development Cooperation

## Centre for Japanese Studies

The Centre for Japanese Studies (CJS), established in 2011 to commemorate the centenary of diplomatic relations between South Africa and Japan, was initially located at the University's Gordon Institute for Business Science (GIBS) at the Illovo Campus in Johannesburg. While at GIBS, the Centre was run by an administrator, Robyn (R) Lin.

In 2015, Prof Cyclic (C) Hartell was seconded from the UP Faculty of Education to the CJS as its first Acting Director, and the Centre moved to the Faculty of Humanities. A faculty administrator's post was transferred to the Centre while the University continued to pay for both posts during this period. During the review period, the CJS did not operate as a typical research centre.

With offices at the Graduate Centre on the Hatfield Campus, the Centre's main function was to assist the Embassy of Japan with activities such as receiving students from Japan and sending students and staff to universities in Japan. Japanese language courses were also offered by the Centre for Continuing Education (CE@UP) under the auspices of CJS.

In 2018, the Centre hosted and facilitated two events, namely the Africa-Asia University Dialogue, which was held from 26 to 18 March 2018, and the South Africa-Japan Bilateral Seminar on 12 September 2018. The latter was the precursor to the 4th SAJU (South Africa-Japan Universities) Forum Conference planned for May 2019.

(GIJZ), the European Union Delegation to South Africa, the Heinrich Boll Foundation, the Mellon Foundation, the Friedrich Ebert Foundation and the Compagnia di San Paolo.

It also coordinated several international research projects and specifically two Framework Programmes of the EU and half a dozen of Erasmus-funded initiatives. It hosted the Governance Innovation Week, an annual gathering of the brightest minds and innovators in academia, policy and civil society. Its high-profile lectures attracted thousands of participants from all over South Africa and beyond, in particular, the Thuli Madonsela Governance Innovation lectures, which were broadcast live on national TV. In 2017, GovInn also hosted the first Wellbeing Economy Festival, which was then replicated in the UK and the USA. At its peak, the centre staffed over 30 researchers, financed almost entirely through external funding.

## Unit for Academic Literacy

Prof Adelia (A) Carstens was appointed as the Head of the Unit for Academic Literacy (UAL) in January 2013 and remained in this position beyond the period under review. Before her appointment, Jurie (J) Geldenhuys served as Acting Head, from July 2009 to December 2012.

In 2015, the Language Unit, led by Joanne (J) Lombard, was transferred to the Unit for Academic Literacy from the Quality Unit at UP. The merger of the Language Unit with the Unit for Academic Literacy resulted in a combined staff complement of 11 namely, eight academic and three administrative staff members.

UAL increased its research output from on average two publications per year in 2009 to eight in 2018. Main research themes focused on academic reading and writing, curriculum transformation, and pedagogy. The Unit also embraced hybrid learning through UP's online platforms. In October 2018, UAL hosted a workshop for UP students and staff, titled *Curriculum Transformation*.

Research project highlights during this period included:

- In collaboration with the University of Cape Town (UCT) and the Department of African Languages at UP, Prof Carstens worked on a project, 'Designing and compiling a multilingual open resource term bank' (2014-2017).
- In 2018, Dr Helena (H) Kruger-Roux and Dr Pineteh (PE) Angu completed a comparative study on bimodal and unimodal English comprehension among students enrolled in the module, Academic English for Health Sciences (ELH121).
- Starting in 2018, Prof Carstens and Dr Avasha (A) Rambiritch undertook a multimodal analysis of video-recordings of student-consultant interactions in a writing centre; the study was intended to inform tutor training.

Staff achievements during this period included Prof Carstens achieving an NRF C2 rating in 2017. Dr William (W) Kelleher completed his PhD in Linguistics at the University of the Witwatersrand (Wits) in 2018, and successfully applied for an NRF postdoctoral scholarship. Notable among student achievements were four students who completed their doctoral and two their master's degrees — all six students were supervised by Prof Carstens.

## Language Unit

The Language Unit is responsible for the implementation of the University of Pretoria's language policy. The University generates vast numbers of texts in a wide range of formats destined for use at institutional level, in the research environment, in the teaching and learning environments, and in the media. The Language Unit helps to ensure that staff and students have access to certain categories of communication in the most relevant languages for the contexts in which the University operates. It has arguably over time achieved the status of a statutory body, which fulfils the requirement that universities must establish or strengthen centres for language development and provide supporting language services.

Joanne (J) Lombard, formerly managing editor at UNISA Press, was appointed in September 2010 as the first Head of the Language Unit following its establishment in 2009 by the Executive of the University of Pretoria. It was situated in the then Department of Academic Administration (now DESA) under the directorship of Dr Dawie (D) Marais.

The establishment of the Unit flowed from Dr Marais's vision to expand the language services being rendered to the Registrar at the time, to become a central Language Unit for the University. Involved in the process were Daleen (D) Malan, Elfriede (E) Ainslie, Marlene (M) Kromberg and Herculene (H) Kotzé (subsequently Dr Kotzé, Deputy Director of the School of Languages at the North-West University). A corporate language policy was developed under the guidance of the Registrar, Prof Niek Grové. Ms Ainslie was deeply involved in the compilation of style guides to ensure consistency in the language services provided.

Alongside editing and translation of official and corporate documents — such as policies and contracts — simultaneous interpreting burgeoned, at first as an institutional service. This meant that administrative meetings, which varied in nature, were interpreted between English and Afrikaans.

In 2012, the Language Unit was repositioned in the institution as a result of the development of a knowledge management structure. The Unit reported to Christa (C) North, Head of the Quality Unit and the Chief Knowledge Officer, and functioned in a matrix structure with the Web Office, the Quality Unit and the Information Governance Unit. This combination of divisions provided for editorial input (the provision of language services to promote and maintain the

quality of information in a multilingual environment) and aspects of implementation of the language policy, which required decisions on the language used in documents and in communication with a range of constituencies which, in turn, impacted on aspects of information governance.

Under Joanne Lombard's leadership the Unit's scope of language services was expanded to include Sepedi and Rosina (R) Msiza was appointed to the team as a Sepedi language practitioner. A trilingual glossary of institutional terms — still published yearly — was created. The Language Unit's ties were expanded to include groups such as the Special Interest Group on Multilingualism (SIGoM) as well as the roundtable on African Languages in Higher Education. Joanne Lombard attended and addressed annual joint conferences of the Linguistics Society of South Africa (LSSA), Southern African Applied Linguistics Association (SAALA) and South African Association of Language Teaching (SAALT). Internally, the Unit established ties with existing support services for students such as the Faculty of Law Language Centre.

In 2013, faculties were assisted in their development of long-term language plans linked to UP's language policy. A survey of courses was undertaken to determine the need for, and resource implications of, text translation and simultaneous interpreting services. Educational interpreting (a version of simultaneous conference interpreting in academic contexts) was piloted in selected fields, for example Geology, to determine students' language needs in the classroom.

Following the restructuring of the Quality Unit in 2015, the best fit for the Language Unit was found to be the Unit for Academic Literacy (UAL) in the Faculty of Humanities. The Director, Prof Adelia (A) Carstens, welcomed the Language Unit as an applied language service complementing the theory being taught in the UAL and encouraged close cooperation.

Professional development endeavours included regular workshops hosted for external language practitioners and an Autshumato translation software course sponsored by the Department of Arts and Culture. Senior language practitioners Dr Matemane (M) Lekganyane and Tildie (T) Williams were appointed in 2014 with Dr Helena (H) Kruger-Roux succeeding Williams in 2017. Their joining the Unit increased the Unit's expertise with their respective specialisation in terminology and educational subtitling. In 2014, Mrs Msiza was promoted to senior administrative assistant in the Language Unit.



### Unit for Creative Writing

The Unit for Creative Writing was established in the Faculty of Humanities in 2007.

When Prof Henning (HJ) Pieterse, the former Director, resigned in 2015, there was a period in which the Unit was largely dormant. It was relaunched in October 2017 with the appointment of Prof David (D) Medalie, an acclaimed scholar and writer, as the new Director.

The relaunch was successful in that the Unit was able to tap into and benefit from the widespread interest in Creative Writing and its development as an academic subject. From the start, the Unit offered master's and doctoral degrees, with the honours module in Creative Writing hosted and taught by the Department of English. With the relaunch, the number of MA and PhD candidates increased substantially.

Although several South African universities now offer degrees in Creative Writing, the PhD and MA in Creative Writing at the University of Pretoria (as designed by Prof Pieterse) are different from most of the other offerings in that students are required to complete a substantial scholarly dissertation or thesis as well as a full-length creative work. This means that they emerge with an enriched and even more substantial qualification.

Among the notable achievements for Prof Medalie in the years between 2009 and 2018 was the graduation of ten doctoral and eight master's students (in English and Creative Writing) whom he had supervised. The Creative Writing programme has drawn a number of established writers, including Dr Fiona Zerbst. Dr Zerbst, a noted South African poet, subsequently published the collection of poems she completed as part of her PhD (which was awarded in 2018) as

*In Praise of Hotel Rooms* (Dryad Press, 2020). In the years since 2018 the diverse interests and profile of the Creative Writing students have expanded considerably, which has been very gratifying. The achievements and creativity of the students (and by implication the quality of the programme) have been commended by international and local external examiners.

In 2010, Prof Medalie published a volume of short stories entitled *The Mistress's Dog* (Pan Macmillan/Picador Africa), which was shortlisted for the University of Johannesburg Literary Award in 2011. The title story, 'The Mistress's Dog', was shortlisted for the Caine Prize for African Writing in 2011. It was also chosen as one of the best short stories of the post-apartheid period and was included in an anthology, entitled *Twenty in 20: The Best Short Stories of South Africa's Twenty Years of Democracy* (Times Media).

Another story, 'Borrowed by the Wind', was shortlisted for the Gerald Kraak Award in 2017 and was subsequently published in 2018 in an anthology entitled *As You Like It: The Gerald Kraak Award* (Vol II) (Jacana/The Other Foundation).

In 2016, Prof Medalie was one of two staff members who were nominated by the Faculty of Humanities for the Vice-Chancellor's Exceptional Supervisor Award. He was nominated again for this UP award in 2018. At an award ceremony of the Faculty of Humanities in 2018, Prof Medalie was named the Faculty's Supervisor of the Year. It was the first time this award was given by the Faculty.

At the invitation of the then Vice-Chancellor of the University of Pretoria, Prof Cheryl de la Rey, Prof Medalie delivered the sixth in a series of lectures known as the 'Expert Lectures'. The lecture, entitled *To Retrace Your Steps: The Power of the Past in Post-Apartheid Literature*, was presented on 1 November 2011.



Dr Imtiaz Sooliman, founder of Gift of the Givers, awarded the Chancellor's Medal, 28 April 2019



## 6 | UP Law

### DEAN'S OVERVIEW

In 2009 the Dean, Prof Christof (CJ) Heyns (2006–2010), was in the process of repositioning the Faculty of Law to strengthen its focus on research and postgraduate students with a strong Africa focus. UP's strategic vision was to become a research-intensive university by increasing postgraduate enrolment and throughput, the quality and quantity of academic staff with doctoral degrees, and research outputs — and UP Law followed suit.

The UP Law's Heads of Departments in 2009 were Profs Frans (F) Viljoen (Centre for Human Rights), Karin (K) van Marle (Jurisprudence), Stéfán (BPS) van Eck (Mercantile Law), Trynie (CM) Boezaart (Private Law), André (A) Boraine (Procedural Law), and Christo (CJ) Botha (Public Law). When Prof Heyns' term as Dean concluded at the end of 2010, Prof Anton (A) Kok was the Acting Dean during 2011. Prof Boraine was appointed as Dean as from 1 November 2011, and served for two terms until 31 October 2019. Prof Kok served as Deputy Dean: Teaching and Learning from 1 January 2010 to 30 June 2018, whereafter Prof Birgit (B) Kuschke was appointed.

In 2012, UP Law aligned its first five-year planning cycle (2012–2016) with the vision, mission and goals of the University's long-term strategic plan, UP 2025. These institutional and faculty-specific plans guided UP Law in respect of projected targets and indicators. The aim was to lead and manage UP Law to improve its international ranking and to become more research-intensive in the contexts of South Africa and Africa. In 2013, and in line with the University's planning cycles, UP Law introduced annual action plans to support its contribution to achieving the vision and goals set out in UP 2025.

South Africa's broad development agenda was also reflected in UP Law's strategic plans. It continued to have a strong focus on governance, development and human rights issues and several other important areas within this ambit, such as access to justice and a fair and just society for all. UP Law focused on its core mandate of capacity building through education and research. Simultaneously, community engagement remained a priority and several avenues were considered to give all undergraduate law students at least some exposure to the lived realities of a broad spectrum of communities. Here the Law Clinic played a significant role, especially in regard to providing access to legal services.



Prof Christof Heyns | Dean, 2006–2010



Prof André Boraine | Dean, 2011–2018 and beyond

In 2018, UP Law also produced the highest number of accredited research outputs, including articles, books and chapters in books of all law schools and faculties at other public universities in South Africa, according to the Department of Higher Education and Training's (DHET) evaluation.<sup>1</sup>

Apart from its academic departments, research centres and units, some staff members also achieved international acclaim through high profile appointments on committees of the United Nations. Three law professors, namely Christof Heyns, Ann (AM) Skelton and Dire (D) Tladi served as international experts on key UN bodies responsible for the development and application of international law. More than two-thirds of UP Law's 70 full-time academics held doctorates at the end of the period under review, and many had received national and international recognition for their research achievements. In 2009 UP Law had 12 NRF-rated researchers; by 2018 this number had increased to 26, including one researcher who received an A-rating, Prof Erika (E) De Wet, and 11 B-rated researchers. Prior to 2018, two extraordinary professors in the faculty were also A-rated, Profs Johan (JD) van der Vyver and Drucilla (DL) Cornell.

Apart from its research contributions and postgraduate education, UP Law remained extremely focused on the importance of undergraduate teaching. UP Law's LLB programme was one of only three LLB programmes at South African public universities that immediately received full accreditation from the Council on Higher Education (CHE) in November 2017. UP Law offers the four-year LLB degree and its teaching philosophy is based on an inquiry-led approach introduced in 2013, following a revision of the LLB degree. In spite of relatively stringent entry requirements, UP Law remained over-subscribed each year during the review period as it is a faculty of choice for many students. At postgraduate levels, UP Law extended its offerings by means of innovative new LLM/MPhil and LLD/DPhil programmes during the review period.

UP Law maintained professional links with the world's most prestigious international bodies, such as the United Nations, the European Union, the African Union, the World Bank and a plethora of foreign universities.

At the level of community service and legal training, the UP Law Clinic is a statutorily recognised legal aid clinic in terms of the Legal Practice Act, 28 of 2014 (as amended) and is duly certified and accredited as such by the Legal Practice Council. The Clinic provides free, quality legal services to the indigent and superior clinical legal education to a cohort of final-

year law students. It has remained a trendsetter for South African law clinics, and in the review period, some of its staff also received the UP Award for Innovation and Community Engagement.

An exceptional feature of UP Law is that it has its own printing press, the Pretoria University Law Press (PULP), an open-access publisher. PULP publishes a number of journals, including the *De Jure*, *African Human Rights Law Journal*, and the *African Disability Rights Yearbook*. In 2018 it published its 200th title, with a landmark publication by Prof Charles (CG) Ngwena, *What is Africanness? Contesting nativism in culture, race and sexualities* that squarely fits into contemporary discussions on race and identity in South Africa.

UP Law did exceptionally well in relation to fundraising during the review period, especially given that it is one of the smaller faculties of the University of Pretoria. In fact, the Centre for Human Rights, a flagship department and research hub of UP Law's internationalisation efforts, was mainly run by means of external funding, as was the Centre for Child Law.

As far as student achievements were concerned, the UP moot society played an active role in preparing students for local and international moot court competitions. Apart from winning a number of important competitions, in 2018, it fielded the best mooters on the Africa continent and ranked 5th in the world in the prestigious Jessup moot competition. Law House was also very active and a leading UP faculty house. Law students served the UP student community, inter alia, through the Constitutional Tribunal and the Student Disciplinary Advisory Panel.

Inevitably, there were also challenges during this period. The negative staff: student ratio remained a significant challenge and one of the areas for which UP Law is penalised in international rankings systems. In 2009 the FTE staff to undergraduate student ratio was 24,1 and by 2018 this had increased to 38,9. Fundraising remained a challenge for law faculties and capacity building of staff, succession planning and the transformation of the academic staff component were further priorities.

### Research themes and entities

Every academic department and research chair, institute, centre or unit in UP Law was involved in the main research themes identified in the UP research plan in one way or another. From 2018, the UN Sustainable Development Goals were factored into UP Law's research themes to

determine how best to contribute to these global goals and to integrate some into existing research strategies and teaching programmes.

Linked to these global goals, the intersections between a broad spectrum of areas of research and collaboration have included, for example: environment, natural resources and society; governance, development and human rights; data and data systems, information and communications technology, cyber law, intellectual property; integrated health systems and environmental law; trade law and business and banking in Africa; identity, dignity and freedom — within an overarching framework of building sustainable futures.

From 2009 to 2018, UP Law established four new research chairs, two centres, one unit and one institute which contributed to the knowledge capacity and identity of the University and UP Law. In addition to the six departments, the full complement of UP Law research entities were, by the end of the review period, the following:

### UP Law's collective contribution

There were many examples in the period under review, of UP Law's collective contribution to the Faculty and the University's knowledge projects. Only a few are highlighted here to illustrate the enormous contributions made, with further elaboration provided in the department and research entity texts that follow.

The Centre for Human Rights (CHR) significantly contributed to UP's focus on postgraduate studies and conferred 61 doctoral degrees during the review period. The CHR introduced master's programmes in Multidisciplinary Human Rights and International Law and HIV in Africa, and in 2015, its first hybrid master's programme, the LLM/MPhil in Sexual and Reproductive Rights in Africa. The CHR exemplified UP's Africa-directed focus. While all its academic programmes focused on knowledge generation from an Africa perspective and brought together students from all over the continent, the LLM (Human Rights and Democratisation in Africa) programme stood out for its collaboration with 13 African partner universities and, on average, its 30 graduates annually. Its African Human Rights Moot Court Competition remained a unique forum for African students to develop skills and knowledge on African human rights. For its work supporting the African Commission on Human and People's Rights, the African Union's human rights watchdog, the CHR received the Commission's NGO Human Rights Prize in 2012.<sup>2</sup>

<sup>1</sup> DHET. 2020. Report on the evaluation of the 2018 universities' research output.

<sup>2</sup> <https://www.chr.up.ac.za/news-archive/2012/1704-centre-for-human-rights-wins-2012-african-union-human-rights-prize>

The **Department of Mercantile Law** also significantly contributed to UP's focus on high quality postgraduate education. New LLM programmes were introduced in Consumer Protection Law, Competition Law, Banking Law, and Insurance Law and Governance. Twenty-nine specialist LLM modules were presented as part of eight LLM programmes. New specialist modules, including the prestigious LLM modules in Advanced Information and Communications Law and Banking Law, were introduced. The LLM in Corporate Law was ranked best in Africa for six years and ranked in the top 100 worldwide. The Department also contributed to UP's focus on Africa. Under the auspices of the ABSA Chair in Banking Law in Africa, postgraduate students from across Africa graduated with LLM and doctoral degrees. The impact of its research outputs was widely recognised as relevant and significant, and several staff members were cited in court judgments, including by South Africa's Constitutional Court and Supreme Court of Appeal.

The **Department of Private Law** increased its postgraduate enrolment and conferred 17 doctoral degrees during the review period. It also offered LLM programmes in Private Law,

Law of Contract, Trust and Estate Law, Child Law, Family Law and Intellectual Property Law. The Centre for Child Law in the Department developed Child Law through strategic litigation, law reform, policy development, public advocacy for the promotion and protection of children's rights and research. It contributed to the presentation of the LLM in Child Law and the output of doctorates. It is globally recognised as a thought leader on children's rights and in 2012, Prof Ann Skelton received the World's Children's Prize for the Rights of the Child.<sup>3</sup>

In 2012, the UP Law Clinic in the **Department of Procedural Law** received its second UP Education Innovation Award. The UP Community Engagement Award followed in 2016 and it also received a civic engagement international prize from Ahfad University in South Sudan.

In 2010, **Prof Christof Heyns**, Dean, and since 2011, Director of the Institute for International and Comparative Law in Africa (ICLA), was appointed as the UN Special Rapporteur on extrajudicial, summary or arbitrary executions for the period 2010 to 2016. In 2016 he was elected as a member of the UN Human Rights Committee for the period 2017 to

2020. Prof Dire Tladi in the Department of Public Law and fellow at ICLA was elected to the United Nations International Law Commission (ILC) in 2012 and re-elected in 2016. As an ILC member, he was appointed as Special Rapporteur on peremptory norms of general International Law (*jus cogens*). On the basis of his four reports, the ILC adopted a set of 23 draft conclusions on peremptory norms of general international law.

Established in 2011, ICLA managed research initiatives with a continental and a global scope and contributed to the research-intensive identity of UP. Some of the research projects included 'Freedom from violence in Africa', which covered various aspects of International Law in collaboration with the UN and the AU, for which it drafted major international instruments on topics such as the peremptory rules of International Law, the Right to Life and the Right of Peaceful Assembly. It housed internationally recognised experts on Africa's constitutions and on Banking and Insurance Law in Africa, and managed websites covering the laws of all countries on police use of force and demonstrations. Importantly too, it was responsible for the participation of UP Law students in the Jessup International Law Moot Court Competition where, in 2018, the UP Law team ranked fifth in the world.

The Department of Public Law introduced an MPhil degree in Medical Law and Ethics and a specialist LLM in Air, Space and Telecommunications Law. The LLM degree in Extractive Industry Law in Africa with the first intake in 2016 was the first of its kind to be introduced in Africa. The Department also introduced other successful postgraduate programmes, namely an LLM in Environmental Law and an LLM in International Humanitarian Law and Human Rights in Military Operations.

### **An overview of performance**

There were several areas of exceptional achievement during the review period, as reflected in this overview, and in the '**performance at a glance**' presented on pages 282 and 283. To highlight a few performance markers in line with UP and UP Law's strategies:

- The focus on postgraduate students is shown in the increase in postgraduate enrolment which more than doubled between 2009 and 2018 — from 327 to 735

<sup>3</sup> <https://worldschildrensprize.org/annskelton>

students, representing a 116% increase. The percentage of black postgraduate students increased from 59,3% to 71,4% in the same period, while the percentage of master's and doctoral black graduates increased from 59,1% to 68% between 2009 and 2018.

- At the same time, the focus on presenting a high-quality four-year undergraduate LLB degree is shown in the success rates of students — an increase from 52,4% in 2009 to 76,4% in 2018, measured as successful FTE students to total FTE undergraduate enrolments. The diversity profile of students also changed. The percentage of undergraduate black students enrolled increased from 37,5% to 54,3% between 2009 and 2018, while black graduates in the same period increased from 29,2% to 41,2%.
- Staff capacity for research and supervision is shown in academic staff with doctoral degrees — from 53,1% in 2009 to 74,2% in 2018, while weighted M and D graduate output per academic FTE staff increased from 0,92 to 2,61 in the same period.

UP Law built on its a good reputation during this review period and remained well-placed in South Africa and Africa as a top provider of legal education at under- and postgraduate levels. In fact, it attracted excellent students from across Africa. What remained in focus concerning foreign postgraduate students, in particular, was that once such students graduate, they return to their countries of origin as UP Law ambassadors and many alumni have served in influential positions in their countries of origin. This Africa-focused networked approach continued throughout the review period. Also, UP Law's local and international connections with the organised professions, research bodies and more, combined with its reputability, established a very strong platform to advance local, regional and international collaboration.

**Prof André Boraine** | Dean, 2011–2018 and beyond

Prof Christof Heyns, an internationally renowned human rights lawyer, teacher and activist, passed away in March 2021. His sudden death was mourned by people the world over. He was one of the founders of the Centre for Human Rights and remained at the forefront of critical yet constructive thinking on human rights.



## UP LAW: PERFORMANCE AT A GLANCE

### Enrolment and success

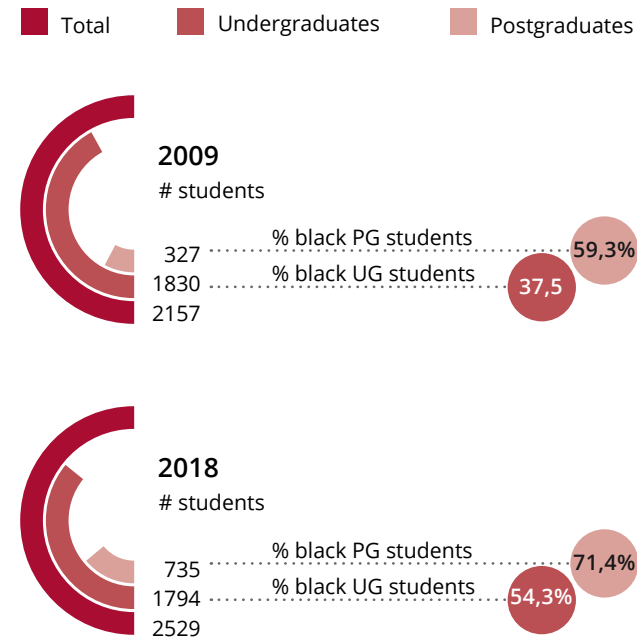

### Undergraduate module pass %

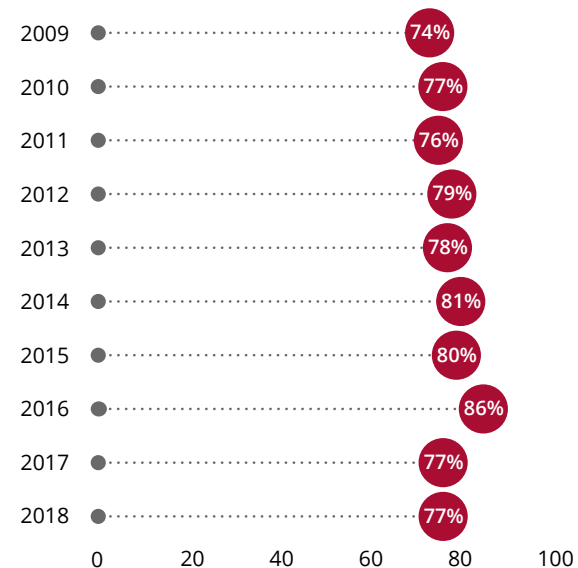

### UG graduates

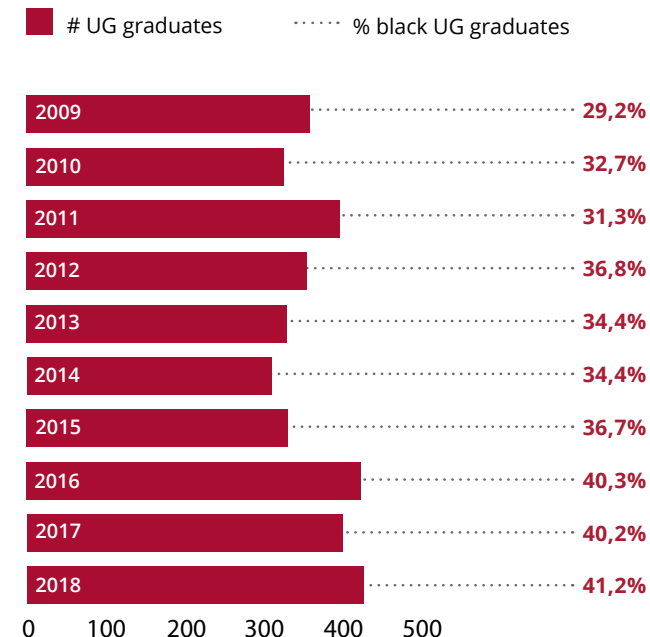

### THE World University Rankings

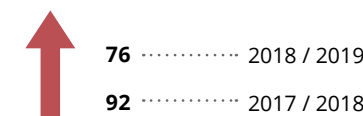

### Student : staff ratio

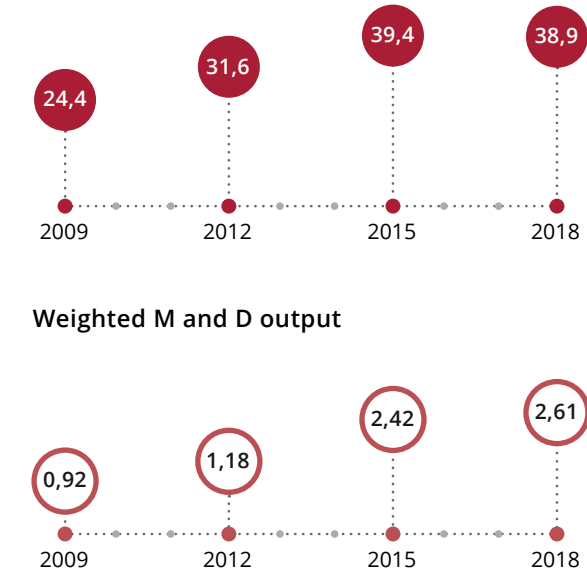

### Weighted M and D output

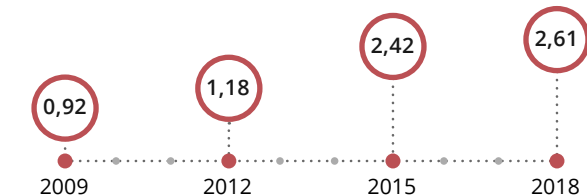

### Research pipeline

#### M and D enrolment

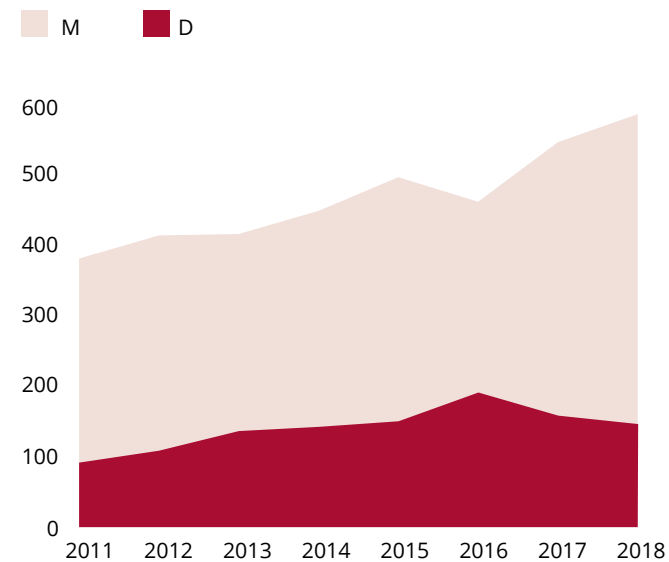

#### M and D graduates

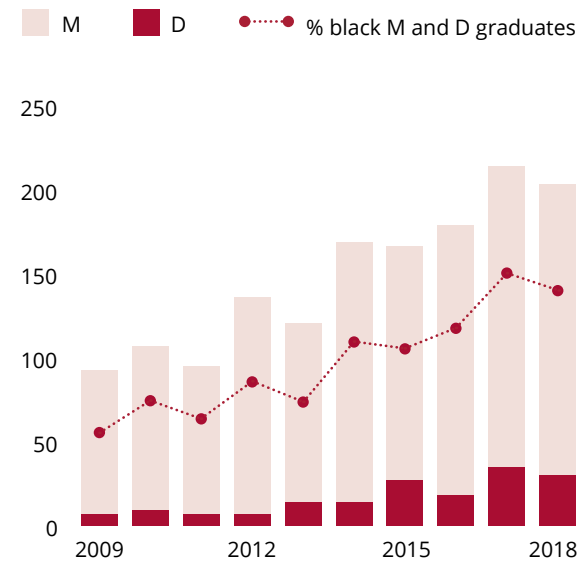

### Capacity and productivity

#### % Academic staff with PhDs

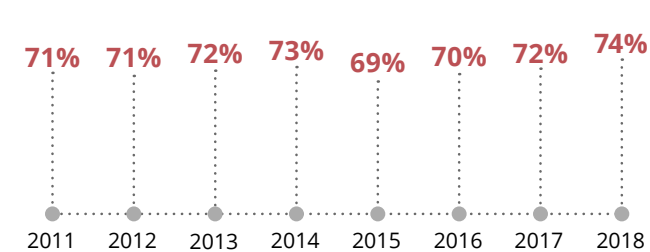

#### NRF-rated researchers, 2018



#### Research output

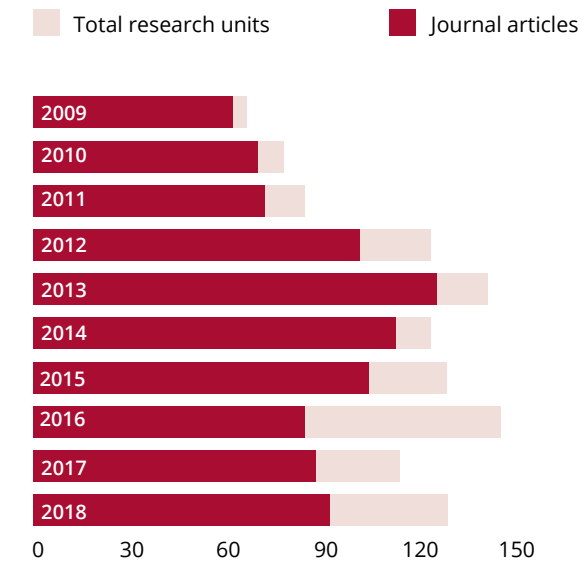

## ACADEMIC DEPARTMENTS

### 1. Centre for Human Rights

The Centre for Human Rights (CHR) is an academic department in UP Law and a centre for the promotion of human rights in Africa through advocacy and research projects funded by external donors. Prof Frans (F) Viljoen was appointed as Director and Head of Department in October 2007, and still held that position at the end of the review period. Dr Nkatha (N) Murungi was appointed as the Assistant Director: Programmes in September 2018.

In addition to six other academic staff members, the Centre employed some 20 project-based staff. Honorary and extraordinary professors were appointed to contribute specific expertise. Dr Edward (E) Kwakwa from the World Intellectual Property Organisation was appointed during the review period.

The Centre is governed by its own Board, whose members included, in the review period, Justice Johann (JC) Kriegler, Justice Bess (Y) Nkabinde, Justice Johann (JV) van der Westhuizen, Prof Sylvia (SR) Tamale, Dr David (D) Padilla and Edouard (E) Jacot-Guillarmod.

The SARChI Chair in International Development Law and African Economic Relations is based in the International Development Law Unit, with Prof Danny (DD) Bradlow as chairholder. The unit undertook research and postgraduate teaching in International Development Law, with a focus on Africa.

As an academic department, CHR offers only postgraduate programmes. During the review period, one of the Centre's flagship programmes remained the one-year full-time LLM/MPhil (Human Rights and Democratisation in Africa), funded by the European Union. Presented with partner universities across the continent, the programme attracts an average of 30 students per year, and is offered in collaboration with Addis Ababa University (Ethiopia), University of Alexandria (Egypt), Catholic University of Central Africa (Cameroon), Makerere University (Uganda), Universidade Eduardo Mondlane (Mozambique), Universite Abomey-Calavi (Benin), Universite Gaston Berger (Senegal), University of Ghana, University of Mauritius, University of Nairobi (Kenya) and the University of the Western Cape in South Africa. In 2013, the programme was opened for the first time to students who were not pursuing a legal career, with an MPhil option added to the LLM stream.

Postgraduate programmes also presented during this period were:

- The LLM (International Trade and Investment Law in Africa) programme, offered in collaboration with the University of the Western Cape. Around 15 students follow this intensive full-time programme at UP every second year.
- The LLM/MPhil programme in Multidisciplinary Human Rights, introduced in 2009; the MPhil stream is open to students who are not following legal careers. Around 15 students registered annually for this two-year part-time programme.
- Between 2011 and 2014, the CHR together with the Human Rights Development Initiative, ran the LLM (International Law and HIV in Africa) programme.
- In 2015, the CHR launched its first hybrid master's programme that combines in-person and online learning, the LLM/MPhil (Sexual and Reproductive Rights in Africa). Around 15 students from across Africa are admitted annually to this two-year programme.
- Another hybrid master's programme, the LLM/MPhil (Disability Rights in Africa) was introduced and developed in 2018, for implementation in 2019. Around ten students from across Africa will be admitted every second year to this two-year programme.

Particular features of all the programmes were the representation of students from across the African continent, and students' exceptional throughput rates, on average one year from registration to graduation. A further achievement in this period was that, between 2009 and 2018, a total of 61 doctoral students graduated from the Centre, with the highest number of 12 doctoral graduates achieved in 2017.

Research on human rights in Africa remained one of the Centre's priorities. Over the review period, the following research and advocacy units were established:

- Business and Human Rights
- Children's Rights
- Democracy
- Disability Rights
- Freedom from Violence
- Freedom of Expression and Access to Information
- Litigation and Implementation Race and Common Citizenship



- Sexual Orientation, Gender Identity and Sex Characteristics
- Women's Rights.

Staff members published numerous articles and books, in addition to the Centre's active involvement in editing and publishing yearbooks, journals and reports. These latter included:

- From 2001, and during this review period, the *African Human Rights Law Journal* which is published bi-annually;
- From 2013, the *African Disability Rights Yearbook*;
- In collaboration with the African Court on Human and Peoples' Rights (African Court), the *African Human Rights Law Reports* (published in English and French); and
- Since 2017, in collaboration with the African Court, the African Commission on Human and Peoples' Rights and the African Committee of Experts on the Rights and Welfare of the Child, the *African Human Rights Yearbook*.

Also noteworthy with respect to the research recognition of academics affiliated to CHR were the NRF ratings achieved in this period: Five academics were awarded B-ratings (Profs Christof (CJ) Heyns, Danny Bradlow, Frans Viljoen, Charles (CM) Fombad and Charles (CG) Ngwenya), and one was awarded a C-rating (Magnus (UM) Killander).

In addition to its strong research output, the CHR is widely recognised for its research and advocacy on human rights in Africa. In 2012, it received the NGO Prize for Human Rights of the African Commission on Human and Peoples' Rights, for its support to the Commission.

The CHR annually collaborates with a law faculty in Africa to host the African Human Rights Moot Court Competition. This vehicle for human rights education brings together over 70 law faculties each year to argue a hypothetical case based on the African Charter on Human and Peoples' Rights. In 2009, the Centre also started organising the Nelson Mandela World Human Rights Moot Court Competition, which initially took place in Pretoria, and from 2014 was organised in Geneva at the seat of the United Nations.



Other projects of the Centre during the review period and beyond, included, the Advanced Human Rights courses which comprise the presentation of up to ten annual one-week courses to senior government officials and members of civil society. Since 2015, the Centre has also housed the secretariat of the African Coalition for Corporate Accountability.

## 2. Jurisprudence

Prof Karin (K) van Marle was appointed as Head of Department of Legal History, Comparative Law and Philosophy of Law, as it was formerly known, in 2008 and reappointed for a second term in 2012.

Following on a departmental review, the Department's name changed to the Department of Jurisprudence in 2012. The identity of the Department started to shift around this time, from a department that used to focus on generic first-year service and skills modules to offering more theoretical and critical modules, and a shift from a narrow conception of jurisprudence to a broader understanding of the discipline, encompassing historical, philosophical and sociological engagement with law and legal theory.

The Department remained extensively involved with first-year students and had as its objective to make all students joining the Faculty of Law feel at home. The Department strove to make the transition for first-year law students from school to university study as smooth as possible, and to lay a sound foundation upon which students could build throughout their academic career. The focus was on the development of critical, creative and independent thought, with staff and students mindful of the need to address social context and the demands of poverty, sexual violence and unequal power relations.

During the period under review, the Department's postgraduate students increased notably, with an increase in the number of master's and doctoral students who graduated. The Department introduced coursework LLM programmes and its research outputs also increased. Some senior colleagues retired or moved to other universities or departments. Staff specialising in critical legal theory were appointed, enabling the Department to improve its gender, age and race profile and to enhance its academic focus on legal theory and legal philosophy.

In 2013, pursuant to the UP's plan to focus on research-intensity and rationalising modules, the Department combined four Introduction to Law and Legal Skills modules into two Jurisprudence modules, and two Roman Law

modules into one module. The Legal Philosophy third-year module was renamed Jurisprudence and Street Law, and a fourth-year elective was renamed Law and the Community.

Annual Ubuntu conferences were arranged on an ad hoc basis during the period 2004 to 2018. A number of Constitutional Court justices and leading scholars participated in these conferences. Profs Drucilla (DL) Cornell, an NRF A-rated philosopher based at Rutgers University (US), Mogobe (MB) Ramose, a leading African philosopher, and Johan (J) van der Walt (Luxembourg) were appointed as extraordinary professors in the Department. The Department also collaborated with the late NRF A-rated scholar, Prof André (AJ) van der Walt, who passed away on 4 November 2016, particularly in the delivery of the Faculty's postgraduate research methodology module. These initiatives improved the research and intellectual profile of the Department considerably.

Past and present members of the Department of Jurisprudence continued to play significant roles in the Faculty of Law, the University, South Africa, Africa and the world:

- Profs Paul (P) van Warmelo, Duard (D) Kleyn and Christof (CJ) Heyns became Deans of the Faculty of Law.
- Prof Johann (JV) van der Westhuizen, the previous Head of Department, was the founding director of the Centre for Human Rights (CHR) and served as a judge in the High Court and the Constitutional Court.
- Prof Philip Thomas is highly respected globally as a legal historian.
- Prof Frans Viljoen is the Director of the Centre for Human Rights and has played a leading role in the promotion of human rights in Africa.
- The late Prof Christof (CJ) Heyns was the UN Special Rapporteur on Extra-judicial Executions and a member of the UN Human Rights Committee.
- Prof Dire (D) Tladi is a member of the UN International Law Commission.
- Prof Caroline (CMA) Nicholson became Dean of the Law Faculty of the University of Free State and, since 2018, the Registrar of UP.
- Prof Anton (A) Kok was the Acting Dean and Deputy Dean of UP Law.
- Prof Annelize (G) Nienaber headed the Department of Public Law.

- Prof Tshepo (T) Madlingozi now heads the leading social justice and civil society organisation, the Centre for Applied Legal Studies (CALS) at Wits University.
- Prof Joel (JM) Modiri was selected as an Inaugural Fellow of the Atlantic Fellows for Racial Equality based at Columbia University (USA) and for the Africa Oxford Law Fellowship at Oxford University (UK).
- The writings and teaching of Prof Karin van Marle (now Deputy Dean of Law at the University of the Free State), Dr Yvonne (Y) Jooste, Dr Isolde (I) de Villiers (now also based at UFS), and Dr Lorette (L) Arendse have made a significant impact on legal research and education in South Africa and elsewhere.

After the end of Prof Van Marle's term as Head of Department, Prof Johann (JV) van der Westhuizen, an emeritus justice of the Constitutional Court and a former director of the Centre for Human Rights, was appointed as Head of the Department from 1 August 2018 to 31 July 2019.

### 3. Mercantile Law

The Department of Mercantile Law is the largest department in the Faculty of Law. Prof Stéfan (BPS) van Eck headed the Department between 2007 and October 2016, followed by Prof Monray (MM) Botha, who became the first black Head of Department at UP Law in 2016. The outcomes of this review period show evidence of high standards and excellence in teaching and learning, research and community engagement.

Eighteen undergraduate modules of relevance to several professions were presented to students from the faculties of Law, Economic and Management Sciences, and Engineering, Built Environment and Information Technology. The Faculty's Teaching Award for 2017 was awarded to the Department's Dr Carika (C) Fritz. The ever-increasing demand to embrace developments in information and communication technologies motivated the Department to introduce an undergraduate module on the intersection between law and technology.

The Department's LLM programmes involved the majority of the postgraduate students in the Faculty of Law. Twenty-nine specialist postgraduate modules were presented as part of eight LLM programmes. The programme curricula met the need for academic and professional development in influential and emerging fields and areas of government interest. New specialist programmes were developed, including Consumer Protection Law, Banking Law, and

Insurance Law and Governance. In 2010, the Department also introduced the LLM module in Advanced Information and Communications Law. The module addressed the many topical issues relating to the 4IR, including artificial intelligence, robotics and the law, data privacy, e-commerce, cybercrime and e-evidence, and telecommunications law. The quality of postgraduate education was evident; to illustrate, the LLM in Corporate Law was, according to the Eduniversal Ranking, the Best Master's programme in Africa from 2012 for a number of years.

In 2018, 68% of staff held doctoral degrees and 40% had received NRF ratings. Prof Corlia (CM) van Heerden was appointed as ABSA Chair in Banking Law in Africa in 2013 and was responsible for the Centre in Banking and Financial Law. Under the auspices of the Chair, she and Prof Reghard (R) Brits established a prestigious LLM in Banking Law as a flagship project in 2016. They supervised doctoral students from across Africa.

The Department's research outputs were recognised as relevant and impactful. To name but a few: Prof Brits received the Vice-Chancellor's Scholarly Book Award of 2017 for his book, *Real Security Law* (Juta, 2016). In 2016 and 2019, Prof Jacolien (J) Barnard received best-contribution awards from the Vereniging Hugo de Groot. The memorandum to the National Credit Amendment Bill, which became the National Credit Amendment Act 7 of 2019, heavily relied on and cited Prof Hermie (H) Coetzee's work in support of the introduction of the debt intervention procedure. In *Jordaan v City of Tshwane* (2017), the Constitutional Court, and in *Firstrand Bank Ltd v Nkata* (2015) the Supreme Court of Appeal, cited Prof Brits' work with approval. The Supreme Court of Appeal also referred to Profs Van Heerden and Stéfan (S) Renke in *Nedbank v National Credit Regulator* (2011), and to Profs Renke and Melanie (M) Roestoff in *Desert Star Trading v No 11 Flamboyant Edleen* (2011). In the period under review, Profs Barnard, Botha, Femida (FM) Cassim, Coetzee, Piet (PA) Delpont, and Jacqueline (J) Church were also referenced in court judgments.

On an international level, Prof Van Heerden was an International Monetary Fund (IMF) accredited banking law expert and incumbent of the Dutch-Belgian 2018/2019 *Tijdschrift voor Privaatrecht Wisselleerstoel*. In the period under review, members of the Department also presented guest lectures at several foreign universities, spoke at numerous international conferences, and collaborated extensively on research projects with their counterparts from local and foreign universities.

The international impact of the Department could be observed in several international organisations. In 2010 Prof Coetzee was a core reviewer of the 'Report on the Treatment of Insolvency of Natural Persons' commissioned by the World Bank. In 2014, the Department launched its flagship bi-annual conference, the *University of Pretoria International Consumer Law Conference* (UPICLC). The conference has attracted renowned keynote speakers, presenters of the highest standard and a continued loyal following by consumer law specialists across the globe. Speakers have included policy makers, regulators and experts from countries all over the world. In 2015, Prof van Eck was a vice-president (Africa region) of the International Society of Labour and Social Security Law, and in 2017, was appointed as president of the African Labour Law Society with members from 28 African countries.

The Department actively engaged with the academic and professional communities. The late Prof Chris (CJ) Nagel was the editor of THRHR (*die Tydskrif vir Hedendaagse Romeins-Hollandse Reg*), a journal that has enjoyed an IBSS status for many years.

In 2017, Profs Barnard and Van Heerden trained delegates from the Department of Trade and Industry (DTI) and the Consumer Tribunal on matters relating to consumer protection law.

### 4. Private Law

During the time under review, the Department of Private Law increased its postgraduate involvement. Seventeen students obtained their doctoral degrees through the Department. The Department also offered LLM programmes in Private Law, Law of Contract, Trust and Estate Law, Child Law, Family Law and Intellectual Property Law.

The Department underwent a change in leadership during this period. After serving two terms as Head of Department, Prof Trynie (CJ) Boezaart retired as Head of Department in 2015, and Prof Steve (SJ) Cornelius was appointed as the new Head of Department in September 2015.

A highlight for the Department was the establishment of the Centre for Intellectual Property Law in 2008 made possible by a generous sponsorship from attorneys Adams & Adams. In 2009 the Adams & Adams Chair in Intellectual Property Law was established with the first incumbent of the Chair, Judge Louis (LTC) Harms.



In addition, four colleagues in the Department were awarded UP Exceptional Academic Achievers' Awards during the time under review: Profs Johan (TJ) Scott, Boezaart, Cornelius and Ann (AM) Skelton.

The Department was also home to the Centre for Child Law, which celebrated its 20th anniversary at the end of the review period. The Centre contributed to the presentation of the LLM in Child Law and the output of doctorates from the Department. During the time under review, the Centre acted as *Amicus Curiae* in several prominent child-related matters that came before the Constitutional Court for adjudication. The Centre firmly established itself as a global thought leader on children's rights and, in recognition, United Nations Educational, Scientific and Cultural Organization awarded the UNESCO Chair in Education Law to the Centre. Prof Skelton held the Chair during the time under review. In 2012, she received the World's Children's Prize for the Rights of the Child. Prof Skelton was also appointed to the UN Committee on the Rights of the Child.

The Department was responsible for undergraduate tuition in all the prescribed subjects within the scope of Private Law, including Law of Persons, Family Law, Legal Pluralism, Law of Contract, Law of Succession, Law of Things, Law of Delict and Private Law 420 (Unjustified Enrichment and Estoppel), as well as a number of electives in the final year of the LLB curriculum.

Several members of the Department were involved in the supervision of master's and doctoral students, and authored or co-authored textbooks and scholarly work during this period, including articles published in peer-reviewed journals and papers delivered at local and international conferences.

Staff who received NRF ratings during the review period were Prof Johan (JD) van der Vyver (A2), Prof Trynie Boezaart (B2), Prof Steve Cornelius (B2), Prof Ann Skelton (B2), and Prof Linda (MC) Schoeman-Malan (C2).

## 5. Procedural Law

Prof André (A) Boraine served as Head of Department of Procedural Law until his appointment as Dean of the Faculty of Law on 1 November 2011. Prof Rian (R) Cloete was appointed as the new Head of Department from July 2012 and was re-appointed for a second term in July 2016.

The Department of Procedural Law has played a significant role in the legal education and development of legal

practitioners in South Africa. It is the primary task of the Department to provide students with a solid foundation for the challenges of practice. During the review period, the Department was responsible for undergraduate tuition in all the prescribed subjects within the scope of Procedural Law, including Civil Procedure, Criminal Procedure, Law of Evidence, Legal Practice, as well as a number of electives (Deeds and Notarial Practice, Alternative Dispute Resolution) in the final year of the LLB curriculum.

Continued collaboration with the various governing bodies of the legal profession contributed to and enhanced the legal skills development of students. This was inculcated through presenting master's programmes in Civil and Criminal Litigation and the Law of Evidence. Further, an LLM module in Sports Law was introduced in 2009.

Several members of the Department were involved in the supervision of doctoral theses and master's dissertations and authored or co-authored textbooks and scholarly work during this period. Members of the Department consistently published articles in peer-reviewed journals, nationally and internationally, and delivered papers at local and international academic conferences.

Further recognition included the appointment of Prof Willem (W) Gravett in 2018 by the Minister of Justice and Correctional Services to the Advisory Committee for the South African Law Reform Commission, and the appointment of Dr Llewelyn (LG) Curlewis in 2017 as defence counsel of the International Criminal Court in The Hague, Netherlands. Prof Rian Cloete was appointed as Tribunal Chair of the South African Institute for Drug-free Sport (SAIDS) in 2015.

Prof André Boraine achieved a B1 NRF rating during this period.

In the period under review, the Department also strengthened its international ties through active involvement in the World Association of Procedural Law. Through international collaboration, Prof Thino (T) Bekker, Prof Willem Gravett and Dr Rashri (R) Baboolal-Frank were elected as members of the International Association of Procedural Law (IAPL) between 2016 and 2018.

## 6. Public Law

The Department of Public Law had several changes in leadership during the review period. After serving two terms, Prof Christo (CJ) Botha retired as Head of Department in

September 2009. Prof Koos (JJ) Malan served in an acting capacity until Prof Charles (CM) Fombad was appointed as Head of Department in 2010. Following Prof Fombad's transfer in 2012 to the Centre for Human Rights (CHR) and the Institute for International and Comparative Law in Africa (ICLA), Prof Ann (AM) Skelton acted as Head of Department until the appointment of Prof Pieter (PA) Carstens in January 2013. When Prof Carstens' term ended in December 2016, Prof Annelize (AG) Nienaber served as acting Head of Department until her appointment as Head of Department with effect from 1 June 2017.

The period witnessed a considerable increase in the research outputs of staff in the Department. Several members of the Department were involved in the supervision of doctoral theses and master's dissertations, and a number authored or co-authored textbooks and scholarly publications during the period under review. Staff also delivered papers at local and international congresses.

By 2018, eight of the 11 academic staff held an LLD degree, and four had received NRF ratings: Prof Koos Malan (C2), Prof

Erika (E) de Wet (A2), Prof Annelize Nienaber (C2), and Prof Philip (GP) Stevens (C2).

Further recognition included Prof Bernard (B) Bekink's election as the chairperson of the Public Law Committee of the International Bar Association for the period 2011 to 2013. Prof Carstens co-authored a book with Dr Patrick (P) van der Heever SC, *Res Ipsa Loquitur in Medical Law* (2011, Juta), the first textbook dealing extensively with this topic in South Africa. Dr Melanie (MJ) Murcott was appointed to the executive committee of the Environmental Law Association of South Africa in 2014, and in 2016 was awarded a fellowship at the University of Tilburg (The Netherlands). In 2012, Prof Dire (D) Tladi was appointed a member of the United Nations International Law Commission, and in 2016, as the Special Rapporteur for *jus cogens*. In 2015, Prof De Wet was awarded the SARChI Chair in International Constitutional Law.

In 2016, Prof Willem (WJ) Jacobs was appointed as an extraordinary professor in the Department to contribute to the postgraduate programmes in extractive industry law and policy. Through his direct involvement, UP Law



African Human Rights Moot Court Competition

was in a position to raise substantial seed funding for the establishment of these programmes.

Following a competitive round, UP Law was selected under the auspices of the Department of Public Law, to participate in the Project Implementation Consortium of the African Mining Legislation Atlas Project (AMLA Project). It was the only Law Faculty from a university in South Africa to be represented. Adv Leon (LJ) Gerber, in his capacity as Programme Head of the Extractive Industry Programmes, was selected to represent UP Law in this forum. The AMLA initiative was initiated by the Legal Vice-Presidency of the World Bank and implemented in collaboration with the African Legal Support Facility and the African Union Commission.

In addition to participating as a Project Implementation Consortium member in sustainability strategy discussions and the conceptualisation of a Five-Year Project Implementation Plan, UP Law was also represented by undergraduate and postgraduate candidates, who were selected annually to participate in 2016, 2017 and 2018 AMLA workshops. The workshops were aimed at identifying possible members of the Legal Research Team of AMLA, with three UP candidates — Leane Louw, Mary-Ann Gettliffe and Nyaradzo Chagwinya — selected for these positions, respectively in 2016, 2017 and 2018, following the workshops.

The extractive industry programmes, under the auspices of the Department of Public Law and the leadership of Adv Leon (LJ) Gerber, successfully hosted the first *Southern African International Arbitration Conference* in 2016. The focus of the particular conference was on bilateral investment treaties and Asia-Africa disputes, with a specific focus on arbitrations in the mineral and hydrocarbon sectors. There were several exciting developments in terms of the introduction of new postgraduate degree offerings during the review period:

- The LLM degree in Extractive Industry Law in Africa, introduced in 2016, was the first degree of this kind in the African region. This was followed, in 2018, by an MPhil degree in Extractive Industry Policy, Management and Regulation.
- Further new programmes in 2018 were the specialist LLM in Air, Space and Telecommunications Law and the LLM in International Humanitarian Law and Human Rights in Military Operations; and in 2015, the LLM in Environmental Law and the MPhil degree in Medical Law and Ethics.
- The Department jointly offers the LLM/MPhil in Disability Law, introduced in 2018, with the Centre for Human Rights.

At the level of undergraduate programmes, the Department was responsible for all the prescribed subjects within the scope of Public Law, including Constitutional Law, Administrative Law, Legal Interpretation, Criminal Law and Public International Law, as well as a number of electives in the final year of the LLB curriculum.

## UP LAW RESEARCH ENTITIES

### *Institute for International and Comparative Law in Africa*

The Institute for International and Comparative Law in Africa (ICLA) was established in 2011 with Profs Christof (CJ) Heyns and Erika (E) de Wet as Co-Directors. The Institute houses research initiatives with a continental and a global scope and researchers from a number of departments in UP Law, as well as international visitors and doctoral students. In 2017, Prof Heyns became the sole Director of ICLA.

Members of ICLA are internationally recognised experts on Africa's constitutions, and on banking and insurance law in Africa. ICLA houses websites covering the Law on Police Use of Force worldwide and on demonstrations.<sup>4</sup>

ICLA is also responsible for the participation by UP Law students in the Jessup International Law Moot Court Competition. In 2018, the team from UP Law was placed fifth in the world.

ICLA's staff includes Profs Charles (CM) Fombad, Dire (D) Tladi (appointed in the Department of Public Law), Niek (NJ) Grové and Corlia (CM) van Heerden (appointed in the Department of Mercantile Law), and honorary professors appointed from abroad, such as Profs Stuart (S) Maslen and Jann (JK) Kleffner, and several postdoctoral researchers who have visited the Institute for short periods.

Although ICLA has received financial support from the University, the most significant funders of its main projects have been the Royal Norwegian Embassy, the Millennium Trust, the Well Spring Foundation and the International Committee of the Red Cross (ICRC).

Freedom from violence in Africa remained a major research focus in the review period, in addition to the work of individual ICLA members, which covers various aspects of international law in collaboration with the United Nations (UN) and the African Union (AU). For these global and

<sup>4</sup> <https://www.policinglaw.info>

Research Entities	est.	Directors/Heads
Institute for International and Comparative Law in Africa	2011	Prof Christof (CJ) Heyns (2011—)
Adams & Adams Centre for Intellectual Property Law	2008	Prof Rian (R) Cloete (Acting, 2009–2012) Prof Steve (SJ) Cornelius (2012—)
Centre for Child Law (CCL)	1998	Prof Ann (AM) Skelton (1998–2018)
Centre for Human Rights (CHR)	1986	Prof Frans (F) Viljoen (2007—)
Centre for Insolvency, Labour and Corporate Law (CILC); formerly the Centre for Advanced Corporate and Insolvency Law, est. in 1995	2016	Prof Stéfan (BPS) van Eck (2016—)
Centre for Law and Medicine	2013	Prof Pieter (PA) Carstens (2013—)
Centre for Sport and Entertainment Law	2002/2009	Prof Rian Cloete (2002— Co-Director, Prof Steve Cornelius (2014—)
Unit for Insurance Law and Governance	2018	Prof Niek (NJ) Grové (2018—)
International Development Law Unit	2009	Prof Danny (DD) Bradlow (2009—)

Research Chairs	est.	Directors/Heads
Adams & Adams Chair in Intellectual Property Law	2009	Judge Louis (LTC) Harms (2009—)
SARChI Chair in International Constitutional Law	2016	Prof Erika (E) de Wet (2016—)
SARChI Chair in International Development Law and African Economic Relations	2018	Prof Danny (DD) Bradlow (2018—)
UNESCO Chair in Education Law in Africa	2010	Prof Ann (AM) Skelton (2013—)
Absa Chair in Banking Law in Africa	2013	Prof Corlia (CM) van Heerden (2013—)

regional organisations, ICLA has drafted major international instruments on topics such as the peremptory rules of international law, the right to life and the right of peaceful assembly.

Perhaps one of the most successful projects has been the Stellenbosch Annual Seminar on Constitutionalism in Africa (SASCA) that started in 2013. As a result of this project, the only five books on African comparative constitutional law, co-edited by Prof Fombad, have been released in a series called, the *Stellenbosch Handbooks in African Constitutional Law*, published by Oxford University Press.

Other remarkable achievements by staff at ICLA included the appointment of Prof Heyns as the UN Special Rapporteur on extrajudicial, summary or arbitrary executions (2010 to 2016) and subsequently, his election as member of the UN Human Rights Committee (2017 to 2020). Prof Tladi has been a member of the UN International Law Commission since 2011. In 2014, Tladi was appointed to serve as its Special Rapporteur for the topic *Jus Cogens*. Since this appointment, Tladi has led

the Commission to give content to *Jus Cogens* by identifying how rules and norms are elevated to the status of *Jus Cogens* and determining their impact in regulating international relations.

NRF rankings for the period under review were Prof Heyns (B1), Prof Fombad (B1), and Prof van Heerden (C1).

### *Unit for Insurance Law and Governance*

The Unit for Insurance Law and Governance was established in 2018 with financial support from the Ubuntu Botho Community Trust. The Unit is housed in the Institute for International and Comparative Law in Africa (ICLA). Prof Niek (NJ) Grové was appointed as the first Director of the Unit.

The flagship programme of the Unit is the LLM programme in Insurance Law and Governance in the Department of Mercantile Law. The first cohort of students to be enrolled for this programme was in 2019.



Prof Dire Tladi, Department Public Law and ICLA

The Unit's vision is to research Insurance Law and the governance of insurance companies, specifically in South Africa and Africa. The first major research project of the Unit was a textbook on South African Insurance Law —*The Principles of South African Insurance Law* (to be published in 2022 by LexisNexis). The authors of this book are Profs Daleen (D) Millard, Birgit (B) Kuschke and Niek Grové.

### Centre for Child Law

The Centre for Child Law (CCL) is located in UP Law's Department of Public Law. Prof Ann (AM) Skelton was appointed as Director of the Centre in March 2008 when Prof Trynie (CJ) Boezaart was promoted to Head of the Department of Private Law. In December 2018, Prof Skelton stepped down as Director of CCL, in a planned leadership succession process. Karabo (RL) Ozah was appointed as Deputy Director in 2017, and was promoted to the position of Director with effect from January 2019.

During the review period, the CCL contributed to the development of Child Law through participating in several high profile cases in the Constitutional Court:

- *Centre for Child Law v Minister of Justice* [2009] ZACC 18 ended the use of minimum sentences for child offenders.

- Also in 2009, the CCL was involved as a friend of the court in *Director of Public Prosecutions v Minister of Justice* 2009 (4) SA 222 (CC), which underscored the importance of taking child victims' testimony in an appropriate way.
- Children removed from their parents was the next issue tackled by the CCL, in *C v Department of Health and Social Development, Gauteng* [2012] ZACC 1, which developed new rules for judicial review of decisions to remove.
- In 2013, the CCL won another landmark case in *Teddy Bear Clinic v Minister of Justice* [2013] ZACC 35, which decriminalised consensual sex between adolescents.
- In the following year, the CCL again attained success in *J v National Director of Public Prosecutions* [2014] ZACC 13, which established that child offenders should not be automatically placed on the sex offenders register as a consequence of being convicted of a sexual offence.
- Appropriate procedures regarding arrest of the children was the subject of another landmark case in which the CCL played a defining role as *amicus curiae*, in *Raduvha v Minister of Safety and Security* [2016] ZACC 24.
- In 2016, the CCL was also *amicus curiae* in a landmark case on the right to identity of children born through surrogacy, *AB v Minister of Social Development* [2016] ZACC 43.

- In 2017, the CCL was *amicus curiae* in *YG v S* [2017] ZAGPJHC 290, a High Court matter that declared the reasonable chastisement defence to be unconstitutional, marking the first step on the road to abolishing corporal punishment in the home.

The CCL enjoyed great success in litigation relating to the right to education, in cases that eradicated mud schools, obtained desks and chairs for learners in poor schools, and impacted on policies for admission and exclusion of learners. Other areas in which the CCL's litigation had an impact on millions of children were in foster care and the payment of social grants.

The CCL also contributed through its research, on themes relating to legal representation of children, the rights of child victims and witnesses, and the rights of children with disabilities. A further focus during this period was on the rights of migrant and undocumented children.

Throughout the period under review, the CCL staff published journal articles and chapters in books, and were involved in teaching the undergraduate elective module on Child Law, as well as the LLM in Child Law.

The CCL, in partnerships with UP Enterprises, also participated in a review of the Children's Act for the Department of Social Development, a 23 country study on adolescents' sexual and reproductive health rights through a contract with the UN Population Fund. It also undertook an impact study on the Child Justice Act through a contract with the South Africa Department of Justice.

Advocacy on children's rights was an ongoing theme, with continual television, radio and print media coverage of the CCL's work. Advocacy also took place at the level of Parliament, as the CCL was consistently active in law reform issues pertaining to children.

The CCL's budget was covered almost entirely from external funds throughout this period, with Prof Skelton's salary funded by the UP as from 2014 when she was appointed full Professor.

### Centre for Intellectual Property Law

The establishment of the Centre for Intellectual Property Law in 2008 in the Department of Private Law was made possible by a generous sponsorship from attorneys Adams & Adams. In 2009 the Adams & Adams Chair in Intellectual Property Law was launched, with Judge Louis (LTC) Harms as the first incumbent of the Chair.

During the time under review, the Centre became nationally and internationally recognised for research on intellectual property law. The Centre took responsibility for and revitalised the LLM in Intellectual Property Law and from the outset attracted doctoral researchers on topics related to intellectual property.

The Centre also hosted an international conference on *Social Responsibility of Intellectual Property Rights Holders* in 2017, co-hosted with the International Association of Intellectual Property and Information Technology Law Teachers and Researchers congress, and in 2018, hosted the *South African Association of Intellectual Property and Information Technology Law Teachers and Researchers* congress.

### Centre for Law and Medicine

Prof Pieter (PA) Carstens managed the establishment of the Centre for Medicine and Law in 2013, under the auspices of UP Law's Department of Public Law and the Department of Forensic Medicine in the Faculty of Health Sciences. The Centre is affiliated with the World Congress of Medical Law and the International Academy of Mental Health Law.

### Centre for Sport and Entertainment Law

The Sports Law Centre was established at UP TuksSport in 2002 and Prof Rian (R) Cloete served as Director. The Centre was moved to UP Law's Department of Procedural Law in 2009 and renamed as the Centre for Sport and Entertainment Law. Prof Steve (SJ) Cornelius was appointed as Co-Director in 2014.

The mission of the Centre is to provide a centre of excellence in providing high quality services, research and courses to the sporting world at large. A memorandum of understanding was entered into between the UP Sports Law Centre and the world-renowned Asser International Sports Law Centre, c/o TMC Asser Instituut, The Hague (The Netherlands) in 2002. In terms of the agreement, both institutions agreed to collaborate in research and educational projects. The Centre also collaborates with the Sport, Exercise Medicine and Lifestyle Institute (SEMLI) at UP. The focus of the collaboration is on scientific, translational research that promotes health and well-being by reducing injuries and promoting sporting excellence.

## Centre for Insolvency, Corporate and Labour Law

The Centre for Advanced Corporate and Insolvency Law (CACIL) was established in the Department of Mercantile Law during the period 1994 to 1995. From 2009 to 2015, the Centre functioned with Profs André (A) Boraine and Piet (PA) Delpont as Co-Directors.

Prof Boraine's workload as Dean, combined with the vision to expand the Centre's scope of research, culminated in the approval of an adopted constitution by the Faculty Board and Senate in 2016. Consequently, the CACIL was replaced and henceforth functioned as the Centre for Insolvency, Corporate and Labour Law (CILC). The Centre's founding management team comprised of three NRF-rated scientists, namely Profs Stefan (BPS) van Eck (Director), and Co-Directors Prof Boraine and Femida (FM) Cassim.

Over the years, members provided input on important law reform and research projects, in particular in relation to insolvency corporate and labour law in South Africa. Members assisted the South African Law Reform Commission with input on the reform of administration orders and commented on reports related to insolvency and corporate law reform. Members were also consulted by the World Bank on South African and Namibian insolvency law reform.

Affiliates of CILC provided input on significant law reform and research projects and were involved in fundraising in respect of student fees and acted as academic leaders in different capacities. Apart from achievements of staff mentioned elsewhere, Prof Van Eck served as one of the vice-presidents of the International Society for Labour and Social Security Law, on the national committee of the South African Society for Labour Law (SASLAW), and as president of the African Labour Law Society representing 18 African countries.

Prof Boraine served on the editorial boards of the *International Insolvency Review* (international ISI journal) and the *Nottingham Insolvency and Business Law eJournal (NIBLeJ)*, and was appointed as a member of the International Insolvency Institute. He also participated in the Insol Fellowship programme and served as the representative for the African region on a committee of the International Insolvency Institute. Prof Boraine obtained a B1 NRF rating during this period, an exceptional achiever award from UP, and served as consultant to the World Bank with regard to the Bank's analysis and reports on the Observance of Standards in Codes (ROSC) of the insolvency and creditors' and debtors' rights regimes of South Africa and Namibia. Profs Boraine

and Hermie (HL) Coetzee were also invited by the Minister of Justice to serve on the SA Law Reform Committee to advise on law reform on debt relief measures for individual debtors.

In addition to the many contributions, UP members of CILC also ran successful LLM programmes in insolvency, labour and corporate law, mainly in the Department of Mercantile Law, and supervised numerous LLM and LLD candidates in these fields.

Some of the key publications and contributions to books during this period were:

- Kunst J, Boraine A, Burdette D, Meskin P. *Insolvency Law Updates* (LexisNexis, annual updates).
- Delpont PA. *Henochsberg on the Company Act* (LexisNexis, annual updates).
- Delpont PA and Kunst J. *Henochsberg on the Close Corporations Act*. (LexisNexis).
- Brits R in G Muller, B Slade, R Brits and J Van Wyk (eds). 2018. *Transformative property law: Festschrift in honour of AJ van der Walt* (Cape Town: Juta Law).
- Cassim MF, in J Yeats, R de la Harpe *et al.* 2018. *Commentary on the Companies Act Original Service* (Cape Town: Juta Law).
- Van Eck BPS, Van Niekerk A, Smit N, Christianson M, McGregor M and Van Eck BPS (eds) *Law@work* 2nd, 3rd and 4th editions.
- Smith A and Boraine A. A South African Corporate Insolvency Law. In *Collier on International Business Insolvency Guide*. (LexisNexis, annual updates).

## UP LAW RESEARCH CHAIRS

### ABSA Chair in Banking Law in Africa

Prof Corlia (CM) van Heerden was appointed as ABSA Chair in Banking Law in Africa in 2013 and is responsible for the activities of the Centre in Banking and Financial Law at UP. The Chair is affiliated with the Department of Mercantile Law and the Institute for Comparative Law in Africa.

Under the Chair in Banking Law, Profs Van Heerden and Reghard (R) Brits established a LLM in Banking Law as a flagship project of UP Law. Over the years several experts from the South African Reserve Bank, as well as Banking Law experts from the World Bank and other national and

international universities have presented lectures on this programme. The Chair has supervised a number of doctoral and master's students from across Africa and is an IMF-accredited Banking Law expert.

On an international level, Prof Van Heerden has collaborated extensively with colleagues from the University of Ghent (Belgium), in particular Prof Reinhard Steennot, where she has also over the years presented guest lectures on their Financial Law programmes. A significant collaboration was also established with Prof Andrew Godwin of the University of Melbourne, Dr Andy Schmulow of the University of Wollongong, and Prof Gail Pearson from the University of Sydney (Australia), and Prof Justin O'Brien from the American University of Sharjah (United Arab Emirates).

This network of collaboration resulted in the first comprehensive academic Twin Peaks Colloquium, which was held in South Africa in September 2017, where experts also presented papers from the South African Reserve Bank and National Treasury on South Africa's new model of financial regulation.

The Chair further collaborated with Prof Nick Huls, emeritus professor at the University of Leiden (the Netherlands), Prof Kenneth Mwenda from the World Bank and Prof Kathleen Huls at Suffolk University, Boston (US). Since 2014, the Chair in Banking Law, in collaboration with the Department of Mercantile Law, has also established a bi-annual *University of Pretoria International Consumer Law Conference*, which attracts scholars from several prestigious universities.

Prof Van Heerden has also presented lectures on selected aspects of banking and financial regulation. On a regular basis she has been invited by the Law Society of South Africa to present seminars on the National Credit Act and Consumer Protection Act. She has also presented seminars on invitation of the Banking Ombud of South Africa and is a regular speaker at the *Annual Banking Law Conference* (ABLU) hosted by the University of Johannesburg.

During the period under review, Prof Van Heerden received a C1 NRF rating.

### The UNESCO Chair in Education Law in Africa

The UNESCO Chairs Programme was established in 1992 by the General Conference of the United Nations Educational, Scientific and Cultural Organisation (UNESCO) to advance research, training and programme development in higher education by building university networks.

The agreement to establish the UNESCO Chair: Education Law in Africa was entered into between UP and UNESCO on 18 March 2010. However, the appointment of a chairholder was delayed due to the lack of funds. A decision was made by UP that an academic from within the ranks of UP would be appointed.

The first chair incumbent, Prof Ann (AM) Skelton, was appointed on 1 April 2013.

The responsibilities of the Chair include:

- Conducting and promoting research in Education Law in South Africa and Africa;
- Promoting good academic education and professional training in education law;
- Playing an active role as an academic leader of the discipline at national and international levels;
- Managing the strategic, academic and operational functions of the UNESCO Chair; and
- Organising fundraising for the activities associated with the Chair.

From April 2013 to the end of 2018, Prof Skelton developed an undergraduate LLB course in Education Law (ONR 420) at UP, which is a final year elective with approximately 100 students per year. She has also supervised numerous master's and doctoral students writing in the field of Education Law.

Prof Skelton has also been at the forefront of strategic litigation in South Africa, having drafted the affidavits and amicus submissions for several landmark cases, including the case to eradicate mud schools.

In her capacity as chairholder, Prof Skelton served as a member of the South African Human Rights Commission's (SAHRC) section 11 Committee on Education from 2011 to 2018. During this time she served as a panel member in three inquiries. The first, an inquiry into the Delivery of learning materials to primary schools in 2013; the second, in December 2016, on protest action in schools; and the third, in March 2018, on Lack of Safety and Security Measures in Schools for Children with Disabilities. These all culminated in reports of the SAHRC. From 2015 to 2016, Prof Skelton was the lead researcher on a three country comparative study on strategic impact litigation on the right to education. This work was commissioned by the Open Society Justice Initiative and culminated in the publication of *Strategic Litigation Impacts: Equal Access for Basic Education*.



From 2017 to 2018, Prof Skelton chaired the Committee of Experts who drafted the *Abidjan Principles on the human rights obligations of States to provide public education and to regulate private involvement in education*.

Prominent publications included:

- Skelton A and Nsibirwa M. 2017. #Schools on fire: Justifiable limitation on the right to protest to protect the right to education. *South Africa Crime Quarterly* (62) 39-50.
- Skelton A and Djouyou Kamga S. 2017. Broken Promises: Constitutional litigation for free primary education in Swaziland. *Journal of African Law* 1-24.
- Skelton A. 2014. Leveraging funds for school infrastructure: The South African 'mud schools' case study. *International Journal of Educational Development* (39) 59-63.
- Skelton A. 2013. The role of the courts in ensuring the right to a basic education in a democratic South Africa: a critical evaluation of recent education case law. *De Jure* 46(1) 1-23.

- Skelton A. 2012. How far will the courts go in ensuring the right to a basic education? *Southern African Public Law* (27) 392-408.

During the period under review, Prof Skelton was a B2 NRF-rated researcher.

### **SARChI Chair in International Development Law and African Economic Relations**

The South African Research Chair Initiative (SARChI) Chair in International Development Law and African Economic Relations was established at UP in 2007, and the incumbent since then, has been Prof Danny (DD) Bradlow. It had completed two successful five-year cycles towards the end of the review period, and would conclude its third cycle by 2022. Funded by the National Research Foundation (NRF), the University has also provided support, including the house in which the International Development Law Unit (IDLU), established under the Chair, is located.

The purposes of IDLU are to train graduate law students in international development and economic law, and to conduct policy-oriented research and stimulate public debate on issues related to the international legal aspects of sustainable and equitable development, and how they affect Africa in general, and Southern Africa, in particular.

The Chair oversees the LLM in International Trade and Investment Law for African Lawyers (TILA) and supervises doctoral students. The aim of TILA, which was created in 2003, is to train African lawyers to structure and negotiate international trade and investment transactions that contribute to sustainable and equitable African development and to help their governments develop the regulatory frameworks that promote such transactions. In the review period, the TILA programme trained 100 students from 23 African countries and nine students from China, France, Germany and Jamaica. In addition, Prof Bradlow successfully supervised seven doctoral students from six Africa countries, three of whom had graduated by 2018. All had registered in 2014/2015, with the remaining four well on the way to completing their doctoral degrees. IDLU also hosted two postdoctoral fellows who helped with the management of TILA, conducted their own research and collaborated with Prof Bradlow on some of his research projects.

Prof Bradlow has also collaborated with legal academics in writing two textbooks that are used to educate law students and lawyers around the world. One of these textbooks is for an innovative course on international business negotiations, and the other is on public international law:

- Bradlow DD and Finkelstein JG. 2018. *Negotiating Business Transactions: An Extended Simulation Course* (2nd edition, Aspen Course Book Series).
- O'Connell ME, Scott R, Roht-Arriaza N and Bradlow DD. 2018. *The International Legal System* (7th edition, Foundation Press).

Prof Bradlow's areas of research are global financial governance and the legal and policy issues relating to public finance and human rights. In 2017, he collaborated with the Centre for Human Rights and Humanitarian Law at the American University Washington College of Law on human rights that led to two workshops and a publication. This work subsequently expanded to collaboration with colleagues at the Global Development Policy Center at Boston University on projects on global economic governance and on the financing of renewable energy in the SADC region.

Previously Bradlow collaborated on book projects on South Africa's foreign policy (with the South African Institute for

International Affairs), on the use of hard and soft international law in promoting social change, and another on legal aspects of international financial institutions (both with a collaborator at American University Washington College of Law) and a book on international law and global financial governance. He and one of the postdoctoral fellows started a book project on sovereign debt in the SADC region in 2018. Prof Bradlow also had a contract with Oxford University Press to write a book on international law and the development of financing institutions. In addition, during his tenure as Chair, Prof Bradlow published 15 articles in law or international relations journals, 15 book chapters or monographs, and numerous short articles in newspapers and on-line media.

### **SARChI Chair in International Constitutional Law**

The SARChI Chair in International Constitutional Law was established in 2016 with Prof Erika de Wet as the first incumbent (2016 to 2019).

The Chair, housed in the Department of Public Law, has maintained a strategic relationship with the Institute of Comparative and International Law in Africa (ICLA). Its focus is on the promotion of research in International Constitutional Law and, more particularly, the system of governance of International Law. This has included questions of law-making, hierarchy and the exercise of power by international organisations.

While mainly funded by the NRF, the Chair has also raised funding for student research visits through the Netherlands-South Africa Foundation (NZAV), the German Academic Exchange Service (DAAD) Scholarship, and the Max Planck Institute Luxembourg for International, European and Regulatory Procedural Law and the Max Planck Institute for Comparative Public and International Law (Heidelberg).

In the period under review, the Chair produced two doctoral and two research master's graduates. Publications included eight articles and chapters in books.

### **University of Pretoria Law Clinic**

The Law Clinic forms part of the Department of Procedural Law and during the period 2009 to 2018, Franciscus (F) Haupt served as its Director. He retired at the end of 2018 after close on two decades of developing the Clinic to become a viable unit of research, teaching and community service.



The Law Clinic provides *pro bono* legal services to poor communities. At the same time, the Clinic enriches UP Law and provides training to final-year LLB students who register for a special LLB elective module. This module also serves as a platform for community engagement of law students, often linked to action research such as the project on emoluments attachment orders. The Clinic presents short courses to generate third-stream income since law clinics in South Africa are generally not well-resourced.

In many ways, the UP Law Clinic serves as a role model for law clinics in South Africa. In 2012, the Clinic received a second education innovation award from UP at the annual Exceptional Achievers' Awards event (the first award was in September 2003), and in 2016 a community engagement award. In 2016, the UP Law Clinic also received a civic engagement international prize from Ahfad University in South Sudan.

### **Pretoria University Law Press**

The Pretoria University Law Press (PULP) was established in 2005. It is an independent press based in the Centre for Human Rights which seeks to strengthen the rule of law and promote legal scholarship on the African continent by publishing primary materials and scholarly texts on law and its related disciplines in Africa. All PULP books are available online in electronic format at no charge at <https://www.pulp.up.ac.za>.

PULP is a registered publisher with the Publishers Association of SA (PASA), the largest publishing industry body in South

Africa, and all material goes through strict peer reviews to ensure accreditation and high quality output. It is also registered with the DOAB (Directory of Open Access Books) database.

PULP's editorial board consisted of Prof Charles (CM) Fombad (convenor), Prof Christof (CJ) Heyns, Prof Frans (F) Viljoen, Prof Femida (FM) Cassim, Dr Gustav (G) Muller, Dr Tshepo (T) Madlingozi, and Mayuri (MM) Pillay. During the review period PULP was managed by Lizette Hermann, marketed by Monique Barnard, and the book stock handled by Sydney Madlhophe.

Over the review period, PULP published five law journals, four of which were available as fully open-access, online journals:

- Since 2013, the *African Human Rights Law Journal*
- Since 2011, *De Jure*
- The *Pretoria Student Law Review*
- Since 2013, the *African Disability Rights Yearbook*, and
- For the first time in 2017, the *African Human Rights Yearbook*.

Since 2005, PULP has published more than 200 publications in multiple languages such as English, Afrikaans, Arabic, French, Swahili and Portuguese for international distribution. On 11 September 2018, PULP marked its 200th publication with the launch of a monograph by Charles Ngwena, titled *What is Africanness? Contesting nativism in culture, race and sexualities*. This book has been lauded as a significant contribution to ongoing discussions about race and identity.





## 7 | Natural and Agricultural Sciences

### DEAN'S OVERVIEW

The Faculty of Natural and Agricultural Sciences (NAS) is one of the largest and most diverse of its kind in South Africa. With about 7 000 students, the Faculty consists of 13 departments and about 40 research entities (viz. institutes, centres, units and research chairs), which are spread across four broad disciplinary clusters: Agricultural and Food Sciences, Biological Sciences, Mathematical Sciences and Physical Sciences.

The period 2009 to 2018 started with the phasing out of the earlier School model. NAS was the first faculty at the University of Pretoria to introduce the deputy deanship model, with the aim to better focus on teaching and learning, research, postgraduate education and community engagement. This was implemented in January 2009 under the leadership of Prof Anton (A) Ströh, Dean of the Faculty from May 2004 until his appointment in July 2014 as Vice-Principal: Institutional Planning. Prof Brenda (BD) Wingfield then served as Acting Dean for eight months. Prof Jean (JM-S) Lubuma was appointed as the new Dean of the Faculty in March 2015, until his retirement in 2019.

The two founding Deputy Deans were Prof Brenda Wingfield: Research and Postgraduate Education, and Prof Johann (J) Engelbrecht: Teaching and Learning. When Prof Engelbrecht was appointed as Acting Vice-Principal: Teaching and Learning of the University in 2012, Prof Marietjie (M) Potgieter acted as Deputy Dean: Teaching and Learning. In September 2013 she was appointed as Deputy Dean in the same portfolio. Prof Wingfield stepped down as Deputy Dean: Research and Postgraduate Education in July 2016 and was succeeded by Prof Edward (EC) Webb.

In 2012, the University of Pretoria launched its long-term strategy, UP 2025. During the one- and five-year planning cycles, NAS distinguished itself as a research-intensive faculty firmly rooted in the realities and needs of Africa. The Faculty continued to strive to be the place of choice for undergraduate and postgraduate students, as well as for academic staff and researchers who wished to excel in natural and agricultural sciences, and to make a difference in addressing the many challenges to development on the continent. The most important achievements, challenges and opportunities are outlined in what follows.



Prof Anton Ströh | Dean, 2004-2014



Prof Jean Lubuma | Dean, 2015–2019

## Students

Student enrolment in NAS grew by 26% in the period under review, from 5 076 in 2009 to 6 742 in 2018 with undergraduate and postgraduate numbers increasing by 40% and 17%, respectively. This rapid growth occurred in the first five years. Careful management of new undergraduate enrolment ensured that numbers stabilised in 2013, with a slight growth in postgraduate enrolments from 2013. The provision of academic posts, however, did not follow this trend, resulting in a significant increase in workload, as reflected by the dramatic change in the ratio of FTE students per FTE academic staff (12,1:1 in 2009 increasing to 23,4:1 by 2018).

Student performance presented a major challenge, especially for the departments of Mathematics and Applied Mathematics, Statistics, and Chemistry, which had the highest student to staff ratios in the Faculty. Moreover, there was a sudden drop in first-year student performance in 2009

as a result, many believed, of the implementation of the new school curriculum and the National Senior Certificate (NSC) exit qualification; 2009 was the first year school-leavers entered universities in South Africa with the new NSC qualification. The reality was that benchmarks and performance standards had not yet stabilised. The widely held view among academics was that there was a mismatch between the exit-level knowledge, skills and competencies of school-leavers and the entry requirements of universities, and that this mismatch was more markedly so in the sciences.

These realities prompted the gradual implementation of a range of interventions, culminating in the FLY@NAS programme aligned with the institutional project FLY@UP. The interventions included:

- The upward adjustment of admission requirements
- The expansion of the tutor system and appointment of faculty student advisors
- The identification of high impact modules for specific support
- Staff development for teaching, whereby various activities such as the Science Teaching and Learning (SCITAL) Forum were established, and
- Curriculum restructuring and renewal.

Although undergraduate student pass rates for Statistics and Chemistry improved significantly and the percentage of successful FTE students increased relative to the total FTE students (2011: 73,6%; 2018: 75,7%), student performance in Mathematics remained a challenge.

There were further achievements in this period:

- Instituting the Dean's Merit List and incentives to reward gifted students.
- A successful Hybrid Fair for UP that was organised in 2016 to showcase the range of technology-mediated teaching methods available to aid student success. The event was well-supported by deans and lecturers from all faculties, and the timing was important as it directly contributed to preparing UP to shift to online teaching almost overnight, following the #FeesMustFall student protests.
- The effective implementation of a hybrid teaching model.
- The provision of web-based (clickUP) support for undergraduate modules, and the consistent improvement of the quality of clickUP use by lecturers and students.

- The inclusion of locally relevant content in all undergraduate degree programmes and, since 2015, the exposure of students to the 17 United Nations Sustainable Development Goals (SDGs).
- The promotion of inclusiveness and diversity of participation at all academic levels, in response to the calls for curriculum transformation after the #FeesMustFall events of 2015 and 2016.

In addition, NAS carried complete responsibility for the academic offering and community engagement projects at the Mamelodi Campus until 2016, when Prof Nthabiseng (NA) Ogude was appointed Dean of this campus. The Faculty consolidated three access programmes — the BSc Extended Year programme and the Foundation Year programme offered at Hatfield, and the BSc 4-year programme offered at Mamelodi — into a new BSc Four-Year Programme (BFYP), which was moved to the Mamelodi Campus in 2010.

Through the BFYP, and outreach programmes to improve learners' performance in Mathematics and Physical Sciences in the surrounding township schools, the Faculty changed the lives of many students with respect to access to study and career trajectories in the sciences (including the health sciences).<sup>1</sup>

## Research and international visibility

The period 2009 to 2018 was one of increased research activity in NAS. Revisiting thematic focus areas in line with international trends was done in three steps:

- First, and specifically in the period 2010 to 2012, the Faculty subscribed to the strategy of Institutional Research Themes (IRT), which led to the establishment of the Institute for Food Nutrition and Well-being, the Genomics Research Institute and the Centre for Viral Zoonoses.
- From 2013 to 2016, the Faculty focused on strengthening the knowledge and research base in high impact research fields and research frontiers, as a means to improve the number of highly cited individuals listed in the Essential Science Indicators (ESI), and to improve citations in general. The number of SARChI Chairs awarded during this period was one indicator of the Faculty's success in this regard.
- Finally, during the subsequent two years, NAS adopted a multi-, inter- and transdisciplinary approach to research, and to teaching and learning.

The main focus was on addressing complex problems, as reflected in the global SDGs, and on increasing the production of quality research outputs and the quality of students. One approach was the NAS REFRESH (Reflecting–Evaluating–Focusing–Recognising–Engaging–Sharing) initiative, which resulted in the development of research foci and platforms, including the Biosciences Forum, Sustainable and Resilient Environments, Big Data and Data Science, and Agriculture.

## Achievements and accolades

There were many outstanding achievements in this period. Some of the international and regional appointments are included here, with further information provided under department and research entity texts:

- Prof Mike (M) Wingfield was elected as president of the International Union of Forestry Research Organizations (IUFRO), 2013.
- Prof Sheryl (SL) Hendriks was appointed, in 2010, as one of three experts from Africa to the Committee for the World Food Security's High Level Panel of Experts for Food Security and Nutrition, and reappointed in 2013 for a further three-year period.
- Prof John (JRN) Taylor was elected as Honorary Life President of the International Association for Cereal Science and Technology, 2015.
- Prof Brenda Wingfield was elected as a fellow of the American Phytopathological Society for her research achievements and outreach to young scientists, 2017.
- Dr Vinet (V) Coetzee and Dr Sanushka (S) Naidoo were elected as fellows of the Next Einstein Forum, 2017–2019.

The following include some of the notable awards:

- Prof Mike (MJ) Wingfield, the African Union Kwame Nkrumah Award for Life and Earth Sciences (2013); and also the Centraal Bureau voor Schimmelcultures (CBS) Fungal Biodiversity Centre's Johanna Westerdijk Award (2012).
- Prof Ignacy (I) Cukrowski, the International Society of Electrochemistry's (ISE) excellence award (2012).
- Prof Jean Lubuma, the Bulgarian Academy of Sciences Sign of Honour Award (2013).
- Dr Thulani (TP) Makhanyane, the International Society for Microbial Ecology (ISME) award for service excellence (2016).

<sup>1</sup> The anchor strategy of the Mamelodi Campus, approved by the Executive in 2017, is elaborated upon in the description which follows in this Chapter under [Section 11, page 405](#).



- Dr Irene (I) Barnes, the Ethel Mary Doidge medal for outstanding early career research in Mycology (2018).
- Prof Egmont (ER) Rohwer, the Alexander von Humboldt Foundation Georg Forster award for his research (2018).

At a national level, the following were among the most prestigious awards bestowed on staff:

- Three NAS staff members received the Harry Oppenheimer Fellowship Award: Prof Robin (RM) Crewe (2012), Prof Brenda Wingfield (2015), Prof Bob (RP) Millar (2016).
- A number of academics received National Science and Technology Forum (NSTF) awards, including: Profs Pat Eriksson (2009), Debra Meyer (2009), Bob Millar (2013), Don (DA) Cowan (2014), Wanda (W) Markotter (2014), Brenda Wingfield (2014), Zander (AA) Myburg (2015), Dr Thulani Mhakilayane (2015), Profs Nigel (NC) Bennett (2015), Dave (DK) Berger (2015), Mmantsae (M) Diale (2018).
- Prof Namrita (N) Lall received the Presidential Order of Mapungubwe Bronze Award (2014).
- Department of Science and Technology, Women in Science Awards: Prof Namrita Lall (2011), Prof Jolanda (J) Roux (2011), Prof Henriëtte (HL) de Kock (2017).
- Prof Bernard (B) Slippers, the AU-TWAS Young Scientists' National Award (2011), and the JE Vanderplank Award for an outstanding young plant pathologist (2013).
- Prof Brenda Wingfield, the Christiaan Hendrik Persoon medal for outstanding research achievements in Plant Pathology (2015).
- The Royal Society of South Africa, John FW Herschel Medal: Profs Bob Millar (2015), and Mike Wingfield (2017).
- The South African Chemical Institute, Chemical Education Medal: Prof Patricia (P) Forbes (2014), Prof Lynne (LA) Pilcher (2017).

At an institutional level:

- Many academics in NAS were recognised by the University as laureates in the annual UP Academic Achievers' Awards in this period.<sup>2</sup> The awards included the Chancellor's Award for Research, the Vice-Chancellor's Award for Outstanding Supervision, the Exceptional Academic Achiever Awards, and the Exceptional Young Researcher Awards.

NAS celebrated the centenary of Agricultural Sciences in 2017. At a centenary event held on 7 November 2017, Dr Johan (J)

van Zyl, previous Vice-Chancellor and Principal of UP (1996–2001), received the Special Award for UP Agriculturalist of the Century.

Finally, NAS was successful in several world rankings, both with respect to individual scientists and knowledge field positions:

- Profs Mike Wingfield and Bernard Slippers were listed in 2018 among the top 1% highly cited researchers globally (Clarivate); also in 2018, UP was ranked in the top 500 universities in the Academy Ranking of World Universities (ARWU).
- In 2017, the Centre for World University Rankings ranked UP as one of the top two universities in Mycology, a focus of the Forestry and Agricultural Biotechnology Institute (FABI).
- A number of subjects were listed in the top 500 globally, including five in the Quacquarelli Symonds (QS) Subject Rankings, one in the Times Higher Education (THE) World University Rankings, and five research fields on the Institute of Scientific (ISI) Web of Science index (now Clarivate analytics), the latter related to citation impact.
- An increasing number of researchers were recognised on the Clarivate/Web of Science ESI list (e.g., 13 in 2013 and 19 in 2018).

### Transformation and change

The Faculty had established a transformation committee, the NAS Transformation Desk, some time before the University made such committees compulsory for all faculties. The NAS Transformation Desk, chaired by the Dean, put in place measures to monitor transformation in the Faculty, which included, for example, a focus on the appointment of leaders who would champion transformation in the Faculty — viz. Heads of Department and Directors of Institutes and Centres. One of the challenges for NAS was to improve the profile of black and female associate and full professors. To achieve targets set, developmental programmes for academic promotions were prioritised, and succession planning for appointments to these ranks.

The following metrics illustrate some of the achievements by the end of 2018:

- 19% of the NRF-rated scientists were black, 19% of the Heads of Departments and Directors were black, and 47% were female.

<sup>2</sup> See Appendix H for a list of UP Academic Achievers' Awards.

- The Faculty was successful in attracting, mentoring and training New Generation of Academics Programme (nGAP) staff.
- The Faculty consistently exceeded the target for the percentage of black contact students to total contact students (2009: 38,3%; 2018: 59,0%).

The #FeesMustFall student protests in 2015 and 2016 led to uncertainty as to the financial sustainability of universities. At UP, the decision to freeze posts and to place a moratorium on support staff dramatically affected NAS. In particular, the repositioning of Sci-Enza to showcase UP research achievements could not materialise and the 'UP with Science' enrichment programme was terminated.

Despite these challenges, NAS continued to excel and lead in raising external funds. It also became more innovative in re-directing resources and re-thinking its 'shape and size':

- Research priorities were rebranded in order to target large-scale research projects supported by international funding organisations.
- Teaching and learning online was highly profiled.
- Restructuring of entities recommended by external reviews led to a major reduction in the number of departments from 17 in 2009 to 13 in 2018. The newly created departments were Plant and Soil Sciences (2015), Consumer and Food Sciences (2017), and Biochemistry, Genetics and Microbiology (2018).

By the end of the review period, the Faculty still needed to complete its audit of space allocation and usage in order to identify and plan for the optimal use of space.

Notable in this period was the new Plant Sciences Building and Complex opened in 2012. This R100m development enhanced existing research in plant sciences and allowed for multi- and transdisciplinary research collaborations across departments and faculties. Also, the completion of state-of-the-art laboratories in the Department of Consumer and Food Sciences in 2017 have provided 60 work stations for student training in the BSc (Culinary Science) undergraduate degree, the only of its kind in southern Africa, and has put UP at the forefront of culinary art and science training.

Due to the high-profile image of Agricultural Sciences, the Faculty championed the development of the Miertjie le Roux Farm for research. In 2018, UP signed an agreement with the Animal Feed Manufacturers Association (AFMA) for the

construction of a Research Feed Mill Laboratory, with financial support from AFMA and a matching contribution from the University.

Finally, NAS played a leading role in the development of the Experimental Farm into a world-class research facility, and the establishment of the Future Africa Institute and research platform on the Hillcrest Campus.

### Performance in overview

The infographic on pages 308 and 309 captures the Faculty's performance measured against key indicators:

- Undergraduate enrolment increased from 3 494 to 4 897 between 2009 and 2018 (or by 40,2%), and postgraduate enrolment from 1 582 to 1 845 (or by 16,6%) over the same period. The percentage black undergraduate students increased from 38,3% to 59,0%, and black postgraduate students from 44,2% to 56,0% by the end of the review period.
- Undergraduate student success measured as the module percentage pass rate remained relatively constant — 73,3% in 2009 and 73,7% in 2018 — with the highest in the in between years being 74,7% (2014).
- Master's and doctoral graduates, taken together, increased from 171 in 2009 to 319 in 2018 (or 87,0%), thereby strengthening the pipeline of future researchers or knowledge workers.
- PhD graduates more than doubled, from 53 in 2009 to 113 in 2018.
- Academic staff with PhDs increased from 172 (57,1%) in 2009 to 258 (83,7%) in 2018, while the weighted M and D graduate output per FTE staff increased from 0,69 in 2009 to 1,91 in 2018.
- Research output, measured as accredited research output units, increased from 287,55 in 2009 to 475,02 in 2018. The majority of journal articles (84–98%) were published in ISI-listed journals.
- A further area where NAS excelled was in the number of NRF-rated researchers that increased from 104 in 2009 to 249 in 2018.

**Prof Jean Labuma** | Dean, 2015-2019

## NATURAL AND AGRICULTURAL SCIENCES: PERFORMANCE AT A GLANCE

### Enrolment and success

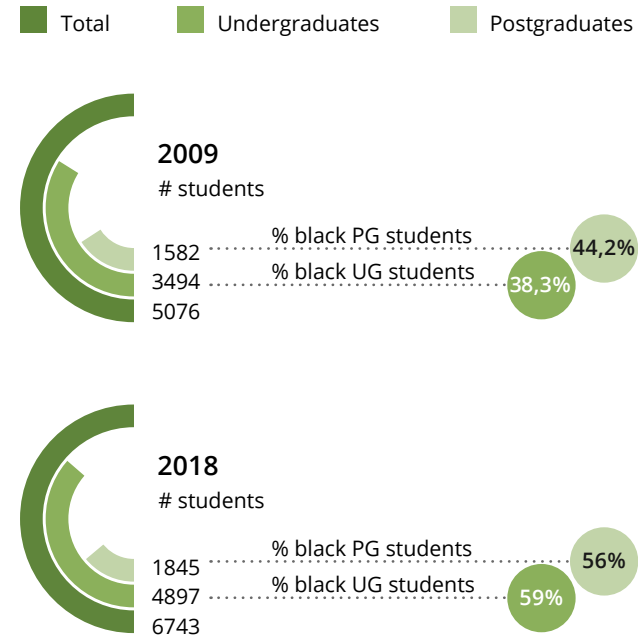

### Undergraduate module pass %

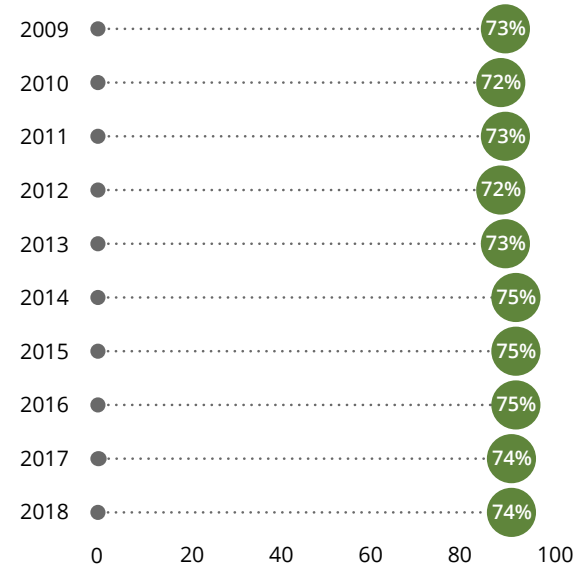

### UG graduates

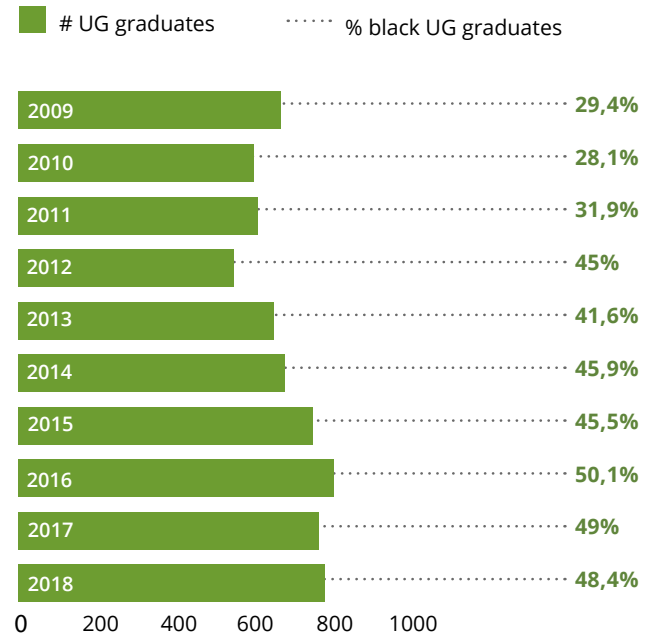

### Student : staff ratio

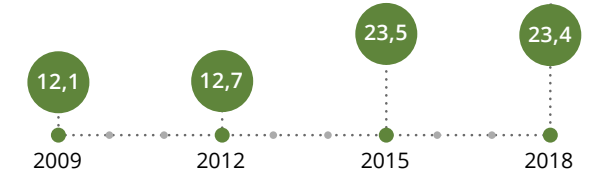

### Weighted M and D output

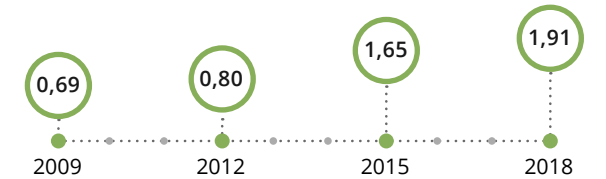

### Research pipeline

#### M and D enrolment

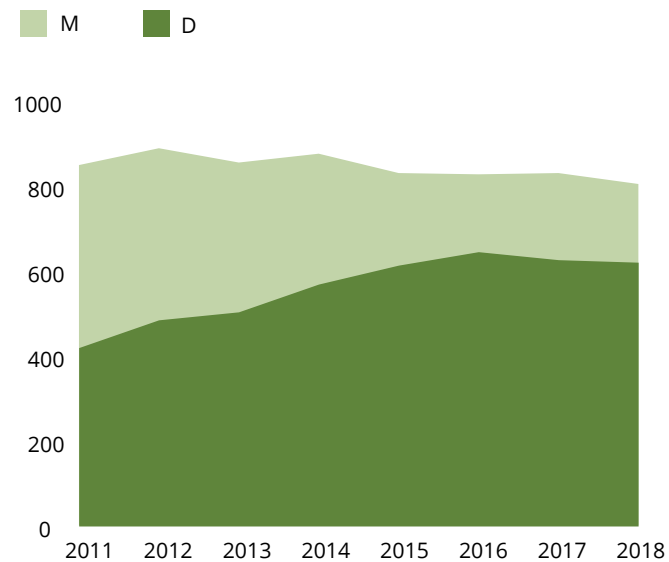

#### M and D graduates

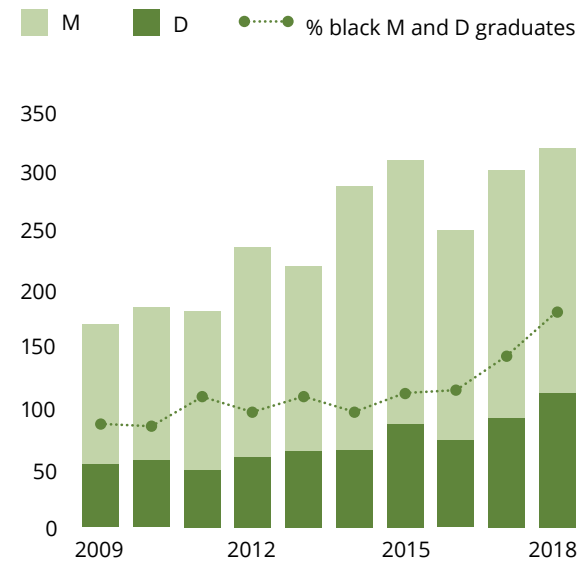

### Capacity and productivity

#### % Academic staff with PhDs

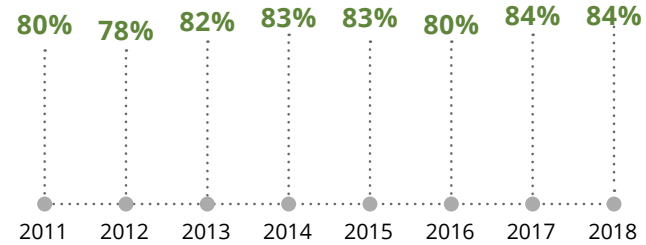

#### NRF-rated researchers, 2018



#### Research output



## DEPARTMENTS

## 1. Actuarial Science

Prof Anton (A) Ströh, Dean of the Faculty of Natural and Agricultural Sciences (NAS), was the Acting Head of the Department of Actuarial Science at the start of the review period in 2009, while serving as Dean of the Faculty. In 2013 Marli (M) Venter was appointed as the new Head of Department. Before her appointment, Marli Venter had served as a senior actuary at ABSA and in managerial positions within the actuarial industry for several years.

In this period, the Department formed strong relationships with the private sector and with regulatory bodies, which led to the appointment of extraordinary lecturers from industry partners. Their involvement in teaching helped students to bridge the gap between theory and practice and also created unique channels of communication between the Department, students and industry. UP graduates are sought after, and the annual careers fair remained one of the highlights of the Department during this period.

Actuarial Science is by definition a multidisciplinary field of study. The Department cooperated with and co-supervised students from a large number of departments and disciplines, including Mathematics, Statistics, Economics, Engineering and Banking Law. While entry requirements are set high for enrolment in the respective programmes, the Department attracted top students and its flagship programmes saw a significant increase in graduate numbers. Between 2009 and 2018, nearly 1 100 bachelor's degrees were awarded.

**Highlights of achievement**

During 2013, the persistent work of Prof Ströh came to fruition and the Absa Chair in Actuarial Science was established to strengthen the research component of the Department. Dr Conrad (FJC) Beyers was appointed as the first incumbent (see below).

The establishment of the Chair contributed to the Department's first master's and doctoral students. Between 2013 and 2018, nine master's degrees were awarded. In 2015, a PhD in Actuarial Science was introduced and Nadine (NM) Walters was the first doctoral graduate in Actuarial Science in 2018, and the first in South Africa for over 15 years.

The Department also hosted its first postdoctoral fellows, Dr Joel (JJ) Dabrowski, in 2015 and 2016, followed by Dr Allan (A) de Freitas, in 2017 and 2018. The fellowships contributed substantially to the Department's research development and output.

The Department's visibility increased significantly during the period as evidenced by numerous instances of media comment, as well as the hosting of the sixth International Conference in Mathematics in Finance in August 2017.

**Developments and change**

The Department saw significant development of its research capabilities and output during this period. This was mainly as a result of the opportunities that were created through the Absa Chair in Actuarial Science. A total of 13 publications appeared in accredited journals, including internationally peer-reviewed journals with impact factors ranging from 2,82 to 6,64.

In 2017, Dr Conrad Beyers won the Actuarial Society of South Africa (ASSA) prize for the best published paper.

The activities of both the actuarial profession and the Department had moved far beyond the traditional practice area of insurance. In 2015 the Department's name was changed from Insurance and Actuarial Science to Actuarial Science to reflect this broader scope of the Department in the context of the changing actuarial and financial services environment.

In the same year, both the undergraduate and honours programmes were reviewed. Changes were made to the required core modules of the programmes to strengthen the skill set of graduates, specifically related to an actuarial and financial mathematics work environment.

The ASSA became the professional body that governs all actuarial activities in South Africa in 2009. This includes oversight of education that leads to the actuarial qualification. UP was the first South African university to obtain full accreditation from ASSA. This accreditation was renewed in 2015. A steering committee, consisting of experienced actuaries from industry and academics from other departments, was established in 2009. This committee met annually throughout the period and provided a platform for industry feedback and a form of quality assurance of the Department's activities.



Staff members of the Department actively participated in various structures of ASSA. This included membership of ASSA's Education Board and chairing of the Tuition Committee by Marli Venter, as well as the appointment of Dr Beyers as Editor of the *South African Actuarial Journal* in 2018.

During 2018, the programme was again reviewed for changes to the Actuarial Society syllabus and, in the process, the Department introduced actuarial science modules at first-year level for the first time. This allowed formal contact between the actuaries in the Department and first-year students, fixing a longstanding perceived weakness. Two options for the degree — Actuarial Science and Financial Mathematics — were also introduced.

The Department continued to work with the South African Actuarial Development Programme (SAADP), initiated in 2009 with President Cyril Ramaphosa as the founder. The programme was instrumental in supporting and mentoring black students towards successful completion of their studies.

In the next decade, the Department would continue to strengthen its research focus, while maintaining and further improving its reputation as a centre of excellence for actuarial education.

**ABSA Chair in Actuarial Sciences**

Since its establishment in 2013, the ABSA Chair in Actuarial Science at the University of Pretoria became a leading actuarial research centre at UP, with Dr Conrad Beyers appointed as the incumbent. Under the auspices of the Chair, various articles were published in leading academic journals.

A number of developments reflected the increase in prominence and stature of the Chair over this period. These included, as noted above:

- The first cohorts of master's and doctoral students completing their degrees — nine master's graduates, and the first PhD in Actuarial Science that was awarded at UP,

as well as the first such PhD in South Africa for over 15 years.

- The hosting of two postdoctoral fellows during this period, Dr Joel (JJ) Dabrowski (2015–2016) and Dr Allan (A) de Freitas (2017–2018).
- Dr Beyers being awarded the ASSA prize for the best research paper in 2017, and his appointment as editor of the *South African Actuarial Journal* in 2018.

In addition, strong ties with local and international academic and industry partners were established. An interdisciplinary research network, with researchers from areas including Mathematics, Statistics, Machine Learning, Economics, Computer Science and Banking Law was developed. An African footprint was established through collaboration with the University of Nairobi (Kenya), with Prof P (Patrick) Weke serving on the Advisory Board of the Chair. Students from several other African countries including Ghana, Nigeria and Zimbabwe were involved in research under the Chair.

Following the establishment of the Chair, more than R4 million in external funding — in addition to funding for the Chair — was obtained in the form of student funding and research grants.

The Chair's visibility was significantly increased through conference contributions, publications, community outreach as well as participation in public debate.

Research included the emerging field of systemic risk research, early warning systems, macroeconomic

modelling, credit rating research together with progress in areas such as fraud risk modelling and the application of new methodologies in credit risk modelling. Advanced methodologies such as machine learning applications were incorporated into these financial fields, where more traditional approaches dominated during this period.

Finally, initial steps were taken in 2017 and 2018 towards community engagement, in collaboration with the Lego Foundation, with the aim of developing cognitive and problem-solving skills in children.

## 2. Agricultural Economics, Extension and Rural Development

Prof Johann (JF) Kirsten, Head of Department since 1997, had his appointment renewed in 2010 and 2014. When he left UP in 2016 to take up a position elsewhere in South Africa, Prof Charles (CL) Machethe stood in as Acting Head of Department. In 2018, Prof Sheryl (SL) Hendriks was appointed as the first female Head of Department.

Further notable leadership roles included:

- Prof Rashid (RM) Hassan, founder of the Centre for Environmental Economics and Policy in Africa (CEEPA) and Emeritus Professor, left UP in 2019 to take up the role of Head of Sudan's Supreme Council for the Environment.

- Dr Tsakani (T) Ngomane joined the Department to lead the Agricultural Extension Programme in 2009 and, in 2010, was seconded to the Department of Planning, Monitoring and Evaluation in the Presidency to lead the National Development Plan Outcome 7 portfolio — Rural Development and Food Security.
- Prof Sheryl Hendriks, who joined the Department in 2010, was appointed Director of the UP Institute for Food, Nutrition and Well-being for the period 2012 to 2018.
- Dr Moraka (MN) Makhura took up the leadership of the Agricultural Research Council and UP's Collaboration Centre for building capacity in the economics of agricultural research in 2018.

In 2017, the Postgraduate School of Agriculture and Rural Development ceased to exist as an autonomous unit and became part of the Department.

The Department is one of the largest of its kind in South Africa, producing the highest number of PhDs in agricultural economics in the country (49 in the period under review). It offers undergraduate degrees in agricultural economics and agribusiness management, honours degrees in agricultural extension, agribusiness management and rural development and master's programmes in agricultural economics, agricultural extension, environmental economics and rural development.

Since 2006, the Department has hosted the Shared Facility for the Collaborative Masters in Agricultural and Applied Economics, receiving between 60 and 90 students from eight partner universities in East and Southern Africa each year. By the end of 2018, over 1 300 students had been hosted in this programme.

### Highlights of achievement

Prof Hassan was awarded the UP Chancellor's Medal in 2010.

The prestigious Agricultural Economics Association of South Africa's FR Tomlinson Commemorative Lecture (accompanied by the award of a medal) was delivered by Prof Kirsten in 2011, by Prof Machethe in 2016 and, in 2018, by Prof Hendriks who was the first female recipient of the medal.

In 2010, Prof Hendriks was appointed to the founding panel of the United Nations Committee on World Food

Security, a high-level panel of experts on food security and nutrition. Prof Hassan served on the panel's drafting team for a report on climate change and food security published in 2012, while Dr Makhura led the drafting of a report on multi-stakeholder partnerships to finance and improve food security and nutrition, which was published in 2018. Prof Eric (E) Mungatana was a lead author for a chapter in the Global Assessment Report by the Intergovernmental Panel on Biodiversity and Ecosystem Services (IPBES) (2016–2018).

Much of the research conducted by staff in the Department continued to have direct policy relevance in the fields of environmental sustainability and climate change, agricultural development and food policy. This included work on sustainable development and climate change led by Prof Hassan, with contributions to the global climate change debate and the State of the Environment Report. Other significant outputs included several publications from the Department where one of the papers, published in the *Journal of Agricultural Science* in 2011,<sup>3</sup> had received over 250 citations by 2018.

On the part of rural development, the Department did remarkable work, including the review of South Africa's Comprehensive Agricultural Support Programme and the Recapitalisation and Development Programme led by Prof Machethe, and research conducted by Prof Hendriks that informed the drafting of the National Food and Nutrition Security Plan for South Africa (2016).

The Department held a substantial grant funded by the Bill and Melinda Gates Foundation. The grant supported 18 PhD students, including two staff members, Dr Danie (D) Jordaan and Dr Melissa (M) van der Merwe. The graduation of these staff members meant that all permanent staff held PhDs by the end of the review period, 2018.

### Programme and qualification changes

The following were programme changes during this period:

- The BInstAgra Honours and MInstAgra degrees were discontinued and replaced with BAgriC Hons and MAgriC, respectively.
- The Department also discontinued the offering of Agricultural Economics as a specialisation in the BAgriC Honours and MAgriC degree programmes.

<sup>3</sup> Deressa TT, Hassan RM and Ringler C. 2011. Perception of and adaptation to climate change by farmers in the Nile basin of Ethiopia. *Journal of Agricultural Science*, 149, 23–31.



### Institute for Food, Nutrition and Well-being

The Institute for Food, Nutrition and Well-being (IFNuW) provides a platform that brings together extensive expertise related to food security across seven faculties and about 35 disciplines. With over 85 expert associates and 120 postgraduate students, this critical mass of researchers seeks to address food insecurity and to find ways of building a more resilient agriculture and food system. The focus is on applying science to solving issues related to producing more food in sustainable ways, food safety, exploiting the health-promoting properties of foods to improve nutrition, influencing what people eat and investigating the impact of policies on food security.

Food insecurity is one of South Africa's most intractable problems, as is reflected in the UN Sustainable Development Goals (SDGs) and in many international and regional declarations and discussions. Tackling these problems requires innovative approaches to research beyond traditional knowledge silos. The appropriateness and need for research at the interface of production, food safety, health, nutrition and economics is evident in recent global and African crises that show the limited ability we have to solve complex and often recurring problems in the agriculture and food system.

The Institute co-hosts, with the University of the Western Cape, the DST-NRF Centre of Excellence in Food Security. It also hosts UP's institutional research theme on Food, Nutrition and Well-being, and at a global level, the UN Academic Impact Hub for SDG 2.

At an institutional level, and as part of the UP 2025 strategy, the University established Institutional Research Themes (IRT) in identified strategic areas that addressed complex societal issues and were capable of significant growth and improving the University's research output and international visibility. Following initial approval from the Executive in 2010, an interfaculty task team was established to develop a business plan for the IRT. This team was led by the Deans of the four founding faculties — Education, Health Sciences, Natural and Agricultural Sciences and Veterinary Science. The 17-person team met regularly over 18 months with the support of Prof Luc (L) D'Haese from Ghent University in Belgium.



Credit: Peter le Roux and Michelle Greve

The discussions identified five key research areas as the focus of the IRT, namely:

- Feeding the world in a resource-constrained environment
- Ensuring safer food through effective control and regulation
- Promoting health, nutrition and well-being
- Changing consumption behaviour for improved health
- Strategic planning and policy reform to manage food security risks.

These focus areas for research provided the organisational structure for the development of Research Themes. The business plan was submitted in August 2011 and approved by the UP Executive in September 2011. An application for the establishment of the virtual Institute for Food, Nutrition and Well-being was submitted and approved in October 2011.

The University's commitment to this initiative is demonstrated by the investment of R10,5 million from UP's strategic reserves, the prioritisation of bursaries and fellowships to support these institution-wide initiatives, and the keen interest and support from the University's Executive in the progress and development of the IRT and Institute. The direct leadership of the deans from five faculties (later to include UP Law), their active encouragement of staff involvement and their active role in management of the IRT is unique.

Prof Sheryl (S) Hendriks was appointed as the first Director of the Institute in October 2011 and the Research Theme Leaders were appointed in January 2012. Each Research Theme Leader is an internationally recognised researcher and active team leader. During the initial phase of the IRT, the Management Team focused on identifying researchers at UP who could support, and projects related to the IRT. Initially over 70 staff members were identified as working on over 50 food security related projects.

The Institute was formally launched in May 2012 by Prof Cheryl de la Rey, UP's Vice-Chancellor and Principal. Sheila Sisulu, the Deputy Executive Director of the World Food Programme, was one of the guest speakers at the event.

### Centre for Environmental Economics and Policy in Africa

The Centre for Environmental Economics and Policy in Africa (CEEPA) was established in 2001 in the Department of Agricultural Economics, Extension and Rural Development. The aim is to enhance the capacity of African researchers to conduct environmental economics and policy inquiry of relevance to African problems and increase the awareness of environmental and economic managers and policy makers of the role of environmental economics in sustainable development.

Prof Rashid (RM) Hassan served as the founding Director of CEEPA till 2016. He served as member of many prestigious national and international boards and science councils, including:

- International member of the National Academy of Sciences (NAS) in the US
- Research fellow of the Economic Research Forum (ERF)
- Member of the Academy of Science of South Africa (ASSAF) and fellow of the World Academy of Sciences (TWAS)
- Senior fellow at Bonn University (Germany), and senior fellow of the African Association of Agricultural Economists.

He received the Chancellor's Medal and was a recipient of four Academic Excellence Awards for Research at UP. Prof Hassan was the founding chief editor of the *African Journal of Agricultural and Resource Economics*, and associate editor and member of editorial boards of many international journals and published over 160 articles and chapters and 14 books by the time of his retirement.

Associate Prof Eric (ED) Mungatana was appointed Acting Director of the Centre from 2017. Other members of CEEPA between 2009 and 2018 included:

- Dr Selma (ST) Karuaihe, a postdoctoral fellow in 2009, part-time lecturer from 2010 to 2012 and appointed as senior lecturer in 2018
- Prof Thomas (T) Lundhede, a visiting fellow and associate professor at the University of Copenhagen, Denmark (2018)
- Prof Damien (D) Jourdain, visiting fellow from CIRAD (2017)
- Dr Babatunde (B) Abidoye, research fellow (2012–2017)
- Prof Greg (G) Hertzler, extraordinary professor (2009–2011)
- Prof Stefano (S) Farolfi, extraordinary professor from CIRAD, France (from 2002)
- Prof Pushpam (P) Kumar, extraordinary professor and senior economic advisor (2015–2018)
- Megan (M) Blore, assistant lecturer (2015–2017)
- Dr Magalie (M) Bourblanc, visiting research fellow from CIRAD (from 2010).

CEEPA staff and members of its network supported the teaching of the Environmental Economics component of the curricula prescribed for regional collaborative master's and PhD degrees in Economics offered and coordinated by the African Economic Research Consortium (AERC). One of the programmes, the Collaborative MA in Applied Agricultural Economics (CMAAE) adopted an equivalent of CEEPA's curricula in environmental economics for one of its specialisation options in natural resources economics.

CEEPA has contributed to capacity building on the African continent and has produced high-ranking environmental economists who have served in different capacities around the globe, which included membership of the African Association of Environmental and Resource Economists (AFAERE).

### Barclays Chair in Agribusiness Management

The Barclays Chair in Agribusiness Management was introduced via sponsorship from ABSA Bank in 1999. Hosted in the Department of Agricultural Economics, Extension and Rural Development, the partnership with ABSA lasted for a period of 19 years, from 1999 to 2018.

Global competitiveness, consumer focus and supply chain issues explained the popularity and career opportunities in agribusiness. In addition, the rising interest in Agribusiness as a discipline allowed this Chair to become part of a portfolio of courses in the Department. The purpose of the Chair was the development and implementation of a mutually beneficial arrangement between ABSA Bank and the Chair in Agribusiness at UP to ensure the long-term sustainability of training and capacity building, the undertaking of dedicated agribusiness research and the development of a talent pipeline through the collaboration.

Prof André (A) Louw held the Chair from 2003 to 2016. Prof Louw was supported by Prof Chris (C) Blignaut (previously Director-General of the National Department of Agriculture), Dr Musa (M) Simulane and Dr André (A) van der Vyfer. Senior students also supported the Chair and were able to complete their PhDs. Among them were Dr Danie (D) Jordaan, Dr Mmatlou (M) Kalaba and Dr Melissa (M) van der Merwe. They were later appointed as academic staff in the Department of Agricultural Economics, Extension and Rural Development.

The core functions of the Chair were tailor-made research, capacity building, talent development and outreach in the agribusiness environment across essential functions in agribusinesses, including finance, value chains and business development. Some accomplishments included:

- The Agricultural Leadership Development Programme (ALDP), offered through Enterprises at UP, was highly rated by future agricultural leaders. ABSA staff presented lectures as part of the course.
- Three three-day Business Planning and Marketing Management Courses were offered on behalf of the Food and Agriculture Organisation of the United Nations through Enterprises at UP. These courses were offered to extension officers from Mpumalanga, Limpopo and KwaZulu-Natal. These courses underlined the importance of capacity building at the extension officer level.
- Journal articles, technical research reports and articles in popular media were published.
- The 5th and 6th editions of the book titled *Finance and Farm Management* (Standard Bank SA) were published in 2013 and 2017.



### 3. Animal Science

In 2017, the Faculty of Natural and Agricultural Sciences celebrated 100 years of Agricultural Sciences at UP. The first Faculty of Agricultural Sciences commenced its activities in 1917 with three departments, one of which formed the foundation of Animal Science at UP — the Department of Animal Breeding. Over the past century, the Department has evolved from a number of small departments in the 1960s to an amalgamated department in 1974 which included animal nutrition, animal physiology and animal breeding.

The name of the Department changed several times but, since 1992, was known as the Department of Animal and Wildlife Sciences, first under the leadership of Prof Norman (NH) Casey. In 2005, Prof Edward (EC) Webb (production animal physiology and meat science) became the Head of the Department. He remained in this leadership position until his appointment as Deputy Dean: Research and Postgraduate Studies of the Faculty. Prof Esté (E) van Marle-Köster (animal breeding and genetics) was appointed as Head of Department in 2016 and became the first female to lead Animal Science at UP.

Following an external review of the Animal cluster in the Faculty, which included the departments of Animal and Wildlife Sciences, and Zoology and Entomology, the Centre for Wildlife Management was closed and the Eugène Marais Chair of Wildlife Management relocated to the Mammal Research Institute (MRI) in Zoology and Entomology. A further name change to the Department was to follow beyond the period under review, in March 2020.

#### Core disciplines and teaching

Animal Science encompasses three major disciplines, namely Animal Breeding and Genetics, Animal Nutrition, and Animal Physiology of livestock, pigs, poultry, game and companion animals. The curriculum of the BSc Agric four-year degree programme has a strong science foundation, followed by applied science and management modules in dairy and beef cattle, small stock, pigs and poultry. The four-year BSc Agric Animal Science degree is recognised for professional registration at the South African Council for Professional Natural Scientists, and is a prerequisite for finding employment in the animal feeds industry and any form of consultancy in the livestock, poultry and pig industry.

The Department uses web-based technology for teaching and learning. Recognising the challenges with increasing student numbers, the costs of using fresh animal cadavers,

health risks and animal welfare, the Department invested in audiovisual material in 2013, followed by plastinated organ specimens for teaching animal anatomy and physiology in 2017, and artificial insemination (AI) has, since 2019, been taught using 'model cows'.

#### Research programmes

The Department of Animal Science is characterised by research programmes in ruminant (dairy, beef, sheep, goat) and monogastric (poultry, pig, horse, dog) nutrition. The examples given below illustrate the research focus areas.

Ruminant nutrition research was led by Prof Lourens (LJ) Erasmus with a primary focus on dairy cattle, including pasture-based and zero-grazing systems. Prof Peter (PH) Robinson, from the University of California Davis (US), an extraordinary professor in the Department, contributed to this research programme.

Dr Linde (L) du Toit and Prof Abubeker (A) Hassen are leaders in nutritional interventions for climate-smart ruminant production to mitigate the effects of greenhouse gas emissions. They have used vitro gas production techniques and open circuit respiration chambers since 2012 to study the effects of feed additives and medicinal plant extracts, encapsulated tannins and tropical grass and shrub species on enteric methane emissions from ruminants.

Dr Christine (C) Janse van Rensburg and Dr Thobela (T) Nkuwkana were responsible for teaching and research programmes in poultry and pig nutrition. Their research foci have included investigating alternatives to antibiotic growth promotants (AGP) and the needs of industry.

The Department has a strong anatomy and production animal physiology research programme under the leadership of Prof Webb, assisted by Dr Ayanda (A) Machashu, and doctoral student Rimbilana (R) Shingange. This programme focused primarily on the effects of nutrition and exogenous molecules on the growth and efficiency of important livestock resources such as indigenous, improved and composite cattle and goat breeds, monogastric animals and selected game species and crocodiles.

Prof Webb served as chair of the crocodile production programme linked to the Exotic Leather cluster from its inception until 2018. The production animal physiology research programme provided critical training and research on applied reproduction technologies and methods to improve the production and reproduction efficiency of

livestock in resource-constrained environments. Prof Webb and co-authors received the David Uys trophy in 2018 for the best scientific article published in the *South African Journal for Animal Science*, 'Influence of bioregion and environmental factors on the growth, size and reproduction of Bonsmara cows'.

#### Highlights of achievement

The Department of Animal Science is renowned for its contributions to the development of the Bonsmara beef cattle breed. A further strength has been the comprehensive undergraduate training in animal genetics; it was the first Animal Science department in South Africa to introduce animal genomics into the curriculum and in postgraduate research.

The Animal Breeding and Genetics programme, of Prof Van Marle-Köster and Prof Carina (C) Visser, has focused on the genomic application for livestock diversity and genetic improvement. The programme has contributed substantially to the genetic knowledge of South African Sanga cattle breeds, and to indigenous sheep and goat breeds for utilisation and conservation. Prof Donagh (DP) Berry, a leader in livestock genomics from TEAGASC — the Agriculture and Food Development Authority in Ireland — has added to research capacity in his role as extraordinary professor in the Department since 2018.

The Department has also played a leading role in the establishment of the Beef Genomics Programme (BGP 2015–2017), whilst Prof Van Marle-Köster was responsible for the management of the Dairy Genomic Programme (DGP 2017–2019) in South Africa.

## 4. Biochemistry, Genetics and Microbiology

The Department of Biochemistry, Genetics and Microbiology (BGM), established as a merged department in 2018, was originally three separate departments: the departments of Biochemistry, Genetics, and Microbiology and Plant Pathology:

- The Department of Biochemistry, the first department of its kind in South Africa, was established in 1940. The heads of department during the review period were Prof Jan (JA) Verschoor (2003–2012), Prof Debra (D) Meyer (2013–2014), and Prof Wolf-Dieter (WD) Schubert who served in an acting capacity from 2015 until the merger in 2018.
- The Department of Genetics, established in 1952 in the former Faculty of Agriculture, merged with the Department of Human Genetics in 2002. Prof Paulette (P) Bloomer served as the Head of Department from 2010, following Prof Henk (H) Huismans.
- The Department of Microbiology and Plant Pathology, established in 1917, underwent changes in 2015 when four academic staff members of the Department joined the Department of Plant and Soil Sciences. In 2009, Prof Huismans was the Acting Head of the Department, followed by Prof Fanus (SN) Venter who was appointed as Head of Department in June 2010 and served until May 2016. At this time, Prof Lucy (LN) Moleleki became the Acting Head of the Department until the establishment of the new merged department in 2018.

The new Department is structured in four divisions, with three as the custodians of the base disciplines Biochemistry, Genetics and Microbiology, and the fourth division for research and postgraduate education. Prof Bloomer was appointed as Head of the Department in 2018, while Prof Anabella (ARM) Gaspar, Dr Vida (V) van Staden and Prof Moleleki served as chairs of the divisions of Biochemistry, Genetics and Microbiology respectively. Prof Schubert was elected as the chair of research and postgraduate education.

### Research and teaching

Among the many notable achievements during the review period were the research chairs awarded to female researchers as part of the DST-NRF South African Research Chairs Initiative (SARChI):

- The SARChI Chair in Sustainable Malaria Control, awarded to Prof Lyn-Marie (LM) Birkholtz in 2013, was approved

for another five-year cycle in 2017 and upgraded from Tier 2 to Tier 1. This is an interfaculty initiative involving the Faculty of Health Sciences and forms part of the UP Institute for Sustainable Malaria Control (UP ISMC). The Institute focuses on all aspects of malaria research and has directly influenced the malaria elimination strategy of South Africa's national Department of Health.

- Prof Brenda (BD) Wingfield was awarded the SARChI Chair in Fungal Genomics in 2015. Prof Wingfield, an NRF A-rated scientist, has focused on population genetics and genomics of fungal tree pathogens. The application is wider than tree crops and has extended ultimately to control diseases of agricultural importance. Thus, the research is relevant to food security, biosafety and conservation.
- In the same year, Prof Wanda (W) Markotter was awarded a SARChI Chair in Animal Infectious Diseases (Zoonoses), while an associate professor in the Department of Microbiology and Plant Pathology. Prof Markotter later transferred to the Faculty of Health Sciences. Her research on the epidemiology and pathogenicity of rabies and rabies-related lyssa viruses has been unique to the African continent, and has contributed to improving the efficiency of rabies diagnosis.

The Research Chairs have contributed enormously to the Department's research outputs, and to infrastructural and human capacity development. To illustrate:

- Several members of the Department have been recognised for their exceptional academic contributions and received either the Chancellor's medal for research, or the UP Exceptional Achiever Awards.
- Several centres and institutes were established and staff in the Department have had linkages with these, as well as pre-2009 established research entities within the Faculty. These include the Centre for Bioinformatics and Computational Biology (CBCB), the Centre for Microbial Ecology and Genomics (CMEG), the Forestry and Agricultural Biotechnology Institute (FABI), and the Mammal Research Institute (MRI).
- Faculty members have also formed part of cross-faculty entities, such as the Genomics Research Institute (GRI), the Animal and Zoonotic Diseases (AZD) Institutional Research Theme, the Institute for Cellular and Molecular Medicine (ICMM), the Institute for Sustainable Malaria Control (UP ISMC), the UP Water Institute (UPWI), the Institute for Food, Nutrition and Well-being (IFNuW).

At the level of undergraduate studies, the Department pioneered the use of Clickers, an interactive learning and teaching tool, in the gateway module, Molecular and Cell Biology (MLB111). This approach facilitates student engagement and real-time monitoring of learning. In addition, lecturers of some undergraduate modules adopted an online teaching platform (from MacMillan, McGraw-Hill and Pearson) that includes reading activities, pre-class assessment quizzes, a full e-book and additional resources such as videos, animations, simulations, and tutorials. These strategies enhanced student engagement and the development of critical thinking skills. Students have the opportunity to visualise theoretical concepts through interactive activities and thereby to develop deeper levels of understanding of new and unfamiliar concepts. Lecturers have reported a marked improvement in student engagement and understanding since the adoption of these online methods of instruction.

### Programme changes

The Department (and the three separate departments before 2016) engaged extensively in the re-circulation of the undergraduate programmes and, since 2013 to 2014, have supported a reciprocal dual major option which provides students with wider career opportunities as well as options for specialisation at postgraduate levels.

Since 2016, and at the level of postgraduate studies, the three earlier departments (and later the merged BGM Department) have, with the Department of Plant and Soil Sciences, presented a joint techniques course covering aspects of molecular biology and bioinformatics. This intensive four-week course is presented at the start of the honours year. A major benefit of aligning the honours programmes of the different departments was that resources and infrastructure could be pooled. The course is followed by discipline-specific advanced technique instruction.

Popular options have included Biochemistry and Genetics with Human Physiology, while for Microbiology the majority of students chose a single major option in Microbiology.

The three departments reduced their honours training programmes from 160 to 135 credits as part of the alignment of postgraduate programmes under the Higher Education Qualifications Sub Framework (HEQSF). Even though each department offers unique modules and module content, the concepts behind several of these are aligned.





### Genomics Research Institute

The Genomics Research Institute (GRI) was formally established as a UP research entity, with Senate approval, in June 2013. The Institute was essentially a rebranding of the Institutional Research Theme (IRT) in Genomics, part of a university-wide executive initiative starting in 2011. Prof Don (DA) Cowan was recruited to the University in May 2012 as Director of the IRT Genomics and was subsequently responsible for both the concept and the process of establishing the GRI as a formal research entity.

As for the other IRTs — five were established across the University — the concept of the GRI was essentially developmental: a funded structure designed to stimulate a research sector which had been identified as a strength in the University, of high global significance and worthy of investment and expansion within UP. With a substantial university budget (approximately R2,5m per annum for five years), the underlying concept of the GRI was to stimulate the application of genomic technologies across the University, particularly in the faculties of Natural and Agricultural Sciences, Health Sciences and Veterinary Science.

As a virtual Institute, the GRI membership was composed of academic staff and postgraduate researchers from across the three faculties. At its peak, GRI membership exceeded 250.

Through the period 2012 to 2016, the GRI provided seed funding, typically of between R50 000 and R220 000, to over 80 researchers across the three science faculties. Seed funding was allocated in response to simple project applications, reviewed by a panel of university experts. Most of the seed funding was targeted specifically at the generation of nucleic acid sequence data: genomes, metagenomes, transcriptomes, amplicon sequence sets, etc., particularly using the Next Generation high-throughput sequencing platforms that were being established across South Africa.

The Institute also held annual day-long research symposia to highlight the development and application of genomics across the University and to provide opportunities for networking and the development of collaborations.

An application to the University Executive, in 2015, led to the allocation of a further two-year budget, allowing the GRI to continue seed-funding genomics research across the University through the period 2017 to 2018.

### African Centre for Gene Technologies

The African Centre for Gene Technologies (ACGT) is a collaborative initiative of science councils and universities in South Africa. The virtual Centre consists of five partner institutions — the Agricultural Research Council (ARC), the Council for Scientific and Industrial Research (CSIR) and the universities of Pretoria (UP), Johannesburg (UJ) and the Witwatersrand (Wits). The Centre is mandated to support the collaborative development of advanced biotechnology research for the benefit of all Africans in key selected areas, including agriculture, health, environment and new technology development.

In 2011, Dr John (JW) Becker was appointed as Director when Prof Jane (J) Morris retired. She continued to serve as a mentor to Dr Becker for several months on a part-time basis. At first the Centre was in the Department of Biochemistry, and then in Genetics, with its offices located on the Hillcrest Experimental Farm.

Several large multinational programmes were conceived and successfully funded. These included the Southern African Biochemistry and Informatics for Natural products network (SABINA), funded for three phases by the Carnegie Corporation of New York through SIG-RISE. Complementary funding was obtained from the European Union-Africa, Caribbean and Pacific (EU-ACP) facility and the DST for related activities in the Policy and Support Actions for Natural Products Network (POL-SABINA). Another programme, Assuring Agricultural and Food Safety of Genetically Modified Organisms in Southern Africa (GMASSURE) was handsomely funded by the EU-ACP, again with complementary funding from DST.

Following several partnership-industry engagements, the Southern African Beef Genomics Programme (BGP) was set up and funded by the Technology Innovation Agency (TIA), with co-funding from industry. Funding secured over the period for large collaborative initiatives totalled well in excess of four-fold return against financial contributions from the partner institutions.

The Centre continued to set up training and capacity building initiatives over this period. Several hands-on workshops have been hosted for partnership researchers by international experts and in excess of a thousand stakeholders benefited from these events. In addition, the Centre hosted more than 30 stakeholder and networking events and has established numerous communication platforms to enable better collaboration among its members, inclusive of a researcher database.

### Centre for Bioinformatics and Computational Biology

The Bioinformatics and Computational Biology (CBCB) Unit was established in 2003 by Prof Fourie (F) Joubert in the Department of Biochemistry, with the help of the then Dean of NAS, Prof Robin (RM) Crewe, and Profs Braam (AI) Louw and Jane (EJ) Morris. The mandate of the Unit was to train postgraduate students in Bioinformatics, perform bioinformatics research, and provide scientific and computational services and support to researchers.

In August 2003, the Unit moved into a dedicated facility in the FABI Square Building and was formally launched in 2004 by Dr Adi (A) Paterson from the DST. Additional staff members appointed included Prof Oleg (O) Reva (2006), Johann (J) Swart (2011) as system administrator, Dr Oliver (OKI) Bezuidt as lecturer (2010–2014), and Dr Charles (CA) Hefer as extraordinary lecturer (2016–2019).

Prof Joubert received an NRF C2 rating and Prof Reva a C1 rating. From 2003 to 2009, the Unit operated with significant funding from the Brazil, Russia, India, China and South Africa (BRICS) programme via the National Bioinformatics Network. Subsequently, the Unit (and later Centre) received an annual support budget from the Faculty. In addition, it has been successful in attracting NRF grants, as well as several other sources of income. Substantial computational infrastructure renewal funding was provided by the University in 2010 and 2017.

Staff were instrumental in the establishment of the South African Society for Bioinformatics in 2012, and Prof Joubert served as the president from 2014 to 2016. The Unit was converted to the Centre for Bioinformatics and Computational Biology in 2014 in the Faculty of Natural and Agricultural Sciences.



**CBCB (continued)**

Postgraduate students, on average, have typically included honours (about 7 students), master's (10) and PhD (5) students per year. Staff numbers have remained the same, and the Centre published 10 to 15 articles per year over this review period. It is anticipated that the Centre will see growth in the number of postgraduate students applying for entry into Bioinformatics degrees, and the number of researchers and postgraduate students needing to be supported in high performance computing. The need for Bioinformatics training and support is expected to increase substantially.

The Centre maintained a number of collaborations within UP, particularly with the Forestry and Agricultural Biotechnology Institute (FABI), the Centre for Microbial Ecology and Genomics (CMEG) in NAS, the Institute for Cellular and Molecular Medicine (ICMM) in the Health Sciences, and the departments of Genetics, Microbiology, Plant Sciences, and Animal Sciences. In addition, Prof Reva collaborated extensively with the South African Medical Research Council (SAMRC) and the Agricultural Research Council (ARC), and Prof Joubert with the ARC. In terms of international collaborations, Prof Reva collaborated with the University of Dar es Salaam (Tanzania), Masinde Muliro University of Science and Technology (Kenya), Cambridge University (UK), National Research Council (CNR, Italy), the Scientific Center for Anti-Infectious Drugs (Kazakhstan), the Institute of Molecular Biology and Genetics of NASU (Ukraine), and Universidade Federal de Minas Gerais (Brazil).

The Centre has also been involved in workshops presented by international researchers on topics such as Linux system administration, genome annotation, genome variant calling, transcriptome analysis and cloud computing.

**Sappi and Mondi Chair in Forest Genomics and Biotechnology**

The Chair in Forest Genomics and Biotechnology was established in 2009 with UP, Sappi and Mondi as founding sponsors and Prof Zander (AA) Myburg as Chair Director. Prof Myburg became the lead principal investigator (PI) of the international *Eucalyptus* Genome Project funded by the US Department of Energy. Given these developments, the mandate and aim of the Chair were to support the development of research capacity and leadership in the areas of forest genomics, forest molecular genetics and tree biotechnology research at UP.

At its inception in 2009, the Chair was embedded within the Forest Molecular Genetics (FMG) Programme at UP, established in 2003 with Sappi, Mondi and UP as founding members. The Chair and FMG Programme were hosted in the Forestry and Agricultural Biotechnology Institute (FABI) and in the Department of Genetics in the Faculty of NAS.

Important outputs of the Chair for the period 2009 to 2018 included the completion of the *Eucalyptus grandis* genome project and its publication in the journal *Nature* (Myburg et al. 2014). A further 65 peer-reviewed research papers were published in this period, many of which leveraged the new *Eucalyptus* genome information to study the evolution and genetic control of growth, development, metabolism and reproduction of *Eucalyptus* tree species. This work attracted R97 million in external funding over the period including R25 million of new government funding from the DST.

In 2014 and 2017, Prof Myburg received the UP Exceptional Achiever Award and in 2015 he received the National Science and Technology Forum (NSTF)-BHP Billiton-W Kambule Award for Contribution to Research and its Outcomes in South Africa. During the period, three additional young academics were added to the leadership in the FMG Programme:

Dr Sanushka (S) Naidoo joined the leadership team to focus on pest and pathogen interactions in forest trees. Dr Eshchar (E) Mizrahi completed a PhD degree in 2013 and was subsequently appointed as contract senior lecturer to focus on the systems and evolutionary biology of forest trees. Dr Steven (SG) Hussey was appointed as a contract lecturer focusing on the transcriptional and epigenetic regulation of wood formation after completing his PhD degree in 2014.

Research on the molecular genetics and genome-assisted breeding for wood property traits in forest trees continued and expanded from *Eucalyptus* trees grown for pulp, paper and cellulose production to include fast-growing pine tree species grown for the timber construction industry. York Timbers joined as the third industry sponsor of the Chair in 2018. Overall, the period 2009 to 2018 constituted a highly productive time for the FMG Programme that saw an expanded reach that included most of the forestry and forest product companies in the country and positioned UP on the forefront of the international forest genomics and biotechnology research arena.

**Centre for Microbial Ecology and Genomics**

The Centre for Microbial Ecology and Genomics (CMEG) was formally established at UP, with Senate approval, in August 2013. The concept for the Centre was developed by NRF A-rated scientist, Prof Don (DA) Cowan, who joined the University in May 2012 as a professor in the Department of Genetics and Director of the Institutional Research Theme in Genomics (subsequently the Genomics Research Institute). The Centre was housed, with Prof Cowan as Director, in newly refurbished laboratories on the third floor of the Natural Sciences II Building.

In the period 2013 to 2018, the Centre grew steadily with an influx of postdoctoral, PhD and MSc researchers, and with the formal inclusion in 2016 of new lecturer, Dr Thulani (TP) Makhwanyane, as the second academic staff member in the Centre. Prof Teresa (TA) Coutinho (UP Department of Microbiology) and visiting professor, Prof Yves van de Peer (University of Ghent, Belgium) formally joined the Centre in 2017, to increase the academic staff membership of the Centre to four.

From its inception, CMEG maintained a very strong publication performance, with a yearly average output of over 20 research papers, reviews and book chapters during the period under review. Almost all publications were in international peer-reviewed journals, many of which were Tier 1 (high impact factor).

The first postgraduate recruitment in 2013 yielded the first CMEG graduates in 2016. Total postgraduate output for the period 2013 to 2018 was 18 (MSc and PhD).

The research focus of CMEG was, at least initially, very strongly driven by the research interests and funding streams of the Director. The two major research programmes focused on hot (Namib) and cold (Antarctic) desert soil microbiomics, both of which involved field expeditions nearly every year and involved very strong international collaboration networks. The third major research programme — the African Soil Microbiomics project (AfSM) — initiated in 2016, involved nine academic partners from different sub-Saharan countries. By the end of 2018, the collaborating laboratories had collected over 900 soil samples from across sub-Saharan Africa, for eDNA extraction and microbial phylogenetics.

Prof Cowan was awarded the University of Pretoria Chancellor's Medal in 2015.

**5. Chemistry**

At the start of the period under review, the Department of Chemistry was challenged with the retirement of a number of senior academics. At the level of leadership, Prof Egmont (ER) Rohwer was appointed as Head of Department in November 2010, following the retirement of Prof Robert (R) Vlegaar. His explicit task was to redefine the academic direction the Department had to take. Prof Rohwer strongly emphasised the complementary nature of fundamental and applied chemistry requiring a focus on interdisciplinary research to address global challenges in water, food and energy supplies, health, education, safety and job creation. In this view he was supported, first by Prof Vlegaar, and after his untimely death in November 2013, by Prof Vinesh (VJ) Maharaj. Prof Maharaj brought in valuable managerial experience from his work at the Council for Scientific and Industrial Research (CSIR), and in October 2016, was appointed as Head of Department, succeeding Prof Rohwer.

**Renewed focus on collaboration**

The Department's new approach meant a renewed focus on collaborative projects in order to enhance the relevance and financial sustainability of Chemistry — an experimental discipline requiring enormous resources to produce research of international impact. Future university and government support would simply not suffice. This position perfectly aligned with the UP 2025 vision under the leadership of Prof De la Rey as Vice-Chancellor and Principal.

In addition to the appointment of Prof Maharaj, a national leader in the field of bioprospecting, the Department was strengthened by the recruitment of a physical chemist, emeritus professor Emil (E) Roduner from Stuttgart University, (Germany) (in 2013), tasked to start a research programme for the electrochemical production of liquid fuel from carbon dioxide (CO<sub>2</sub>). This renewable energy theme was a unique niche area of obvious interest to South Africa in view of its superior solar power potential and the growing international concern over global warming.

Prof Roduner brought in Dr Shankara (SG) Radhakrishnan from India (2013) as postdoctoral fellow to assist in his task. The recruitment of Dr Darren (DL) Riley from the South African chemical industry (2012) to promote his interest in flow synthetic methods in pharmaceutical chemistry, completed the three new departmental directions of high local relevance and international impact. Together with the established departmental efforts in environmental science, insect semiochemicals, forensic pathology, medicinal chemistry, chemical education, waste valorisation, novel materials for alternative and renewable energy, and catalysis with computational chemistry and nanotechnology as cross-cutting technologies put the UP Chemistry Department in a unique position as far as local and African relevance is concerned.

That the Department for the first time in its history was ranked in the 451-500 category in the international Quacquarelli Symonds (QS) ranking for 2017/2018, was a superb achievement. This was mainly due to the increased research outputs and the improved staff profile (including extraordinary appointments) during the reporting period. It was achieved against the backdrop of several challenges, most notably the country-wide #FeesMustFall student movement in 2015/2016 and the budget cuts that followed. The staff members of the Department, however, showed remarkable resilience in these tough times. Hybrid teaching models were adopted, and research outputs were maintained and, in some cases, even improved.

### Challenges and achievements

The Department's capacity was stretched to the limit with large enrolment numbers and firm control measures to improve pass rates, had to be put in place. As an example, the engineering and science first-year Chemistry modules (CHM 171 and 172; CMY 117 and 127) were identified as high impact modules requiring additional attention in 2009, due to the high number of students and relatively low pass rates. Various interventions, including summer and winter catch-up schools, frequent assessments and an intensive tutoring programme resulted in an improvement of average pass rates for all first-year modules from 65 to 74%. This, despite the overall student to full-time equivalent (FTE) staff ratio more than doubling from 15 to 32 during this period. Credit went to a relatively small number of staff members willing to fully dedicate themselves to first-year teaching.

The Chemistry Department was one of the early adopters of UP's proposed hybrid model with the introduction of online

tutorial systems at first-year level in 2014. Online tutorials supplemented normal lectures and practicals, providing an opportunity for students to get rapid, individual feedback. Some of the efforts of staff were recognised:

- Drs Lynne (LA) Pilcher and Riley, together with Dr Kgadi (KC) Mathabathe, from the Department of Science, Mathematics and Technology Education in the Faculty of Education, won the UP Laureate Award for Teaching Excellence and Innovation in 2015, while Prof Patricia (PBC) Forbes won the same award in 2016.
- Prof Forbes and Dr Pilcher were recipients of the Chemical Education Award of the South African Chemical Institute in 2014 and 2017, respectively.
- A highlight of 2017 was Nick (N) de Beer's award of best first-year lecturer at the University of Pretoria, as judged by first-year students.

### Infrastructure and equipment

Teaching infrastructure had to be improved to accommodate the large number of students. In 2011, the renovation and upgrading of two of the three first-year laboratories was completed. The upgraded facilities allowed 290 first-year students in the laboratories per practical session; with nine sessions per week, which translated to 2 610 students. Additional funding of approximately R35m was obtained during the period 2011 to 2017 to complete the upgrading of the remaining facilities in the Chemistry Building. The basement of the Natural Sciences Building, previously hosting the Merck Chemical store, was also refurbished into a natural product biodiscovery laboratory, serving the needs of the new Bioprospecting drive in the Department.

As a result of the improved infrastructure, the number of third-year students doubled to reach 75 by 2017; the number of fourth-year students steadily increased from 10 (2011) to 18 (2018) and had to be limited due to their practical projects requiring specialist supervision and infrastructure.

The acquisition, operation and maintenance of sophisticated research equipment strongly emphasised the need to enter into collaborative interdisciplinary research programmes, as captured in the departmental vision. Such collaborative action resulted in:

- The acquisition of a state-of-the-art Waters Synapt UPLC-QTOFMS and a Bruker HPLC-SPE-MS-500MHz NMR, which placed the Department in a strong position to identify unknown compounds in complex mixtures.

Both acquisitions were made possible by the National Equipment Fund of the NRF, allowing researchers of repute — in this case, Prof Rohwer with Prof Duncan (AD) Cromarty from the Health Sciences Faculty, and Prof Maharaj, respectively — to apply for unique instrumentation, provided sufficient support was demonstrated in the South African scientific community for shared use.

- The acquisition of the UP-funded Bruker D8 Venture single crystal diffractometer (dual wavelength system with molybdenum and copper X-ray sources including low temperature attachment) in 2012.

The diffraction facility would be expanded by the introduction of a Rigaku Synergy Cu and Mo protein diffractometer, for which NRF and UP funding was obtained in 2017 by Prof Wolf-Dieter Schubert from the Department of Biochemistry.

- In 2008, a collaborative effort between Food Science, Chemistry and Chemical Engineering resulted in the purchase of a Mettler Toledo DSC 1 Differential Scanning Calorimeter (DSC) as well as a Mettler Toledo High Pressure DSC System with Faculty funding. This system was complemented in 2016 when the Chemistry Department purchased a simultaneous DSC-TGA analyser (Q600 SDT).

The Department's attempts at improving the computational facilities relied heavily on the know-how and experience of Dr Jannie (J) Pretorius who played a key role in the interfaculty High Performance Computing Strategy Committee (UPHCSC).

The Department's vision of locally relevant research and specialist training incorporates the often mentioned third core activity of UP, namely community service. Two long-term structured contributions stood out as flagships for the Department:

- The activities of the Forensic Toxicology Laboratory, under the leadership of Dr Tim (TB) Laurens.

The Forensic Toxicology Laboratory maintained its ISO17025 accreditation status, since its inception as the only accredited forensic toxicology laboratory in South Africa, with five accreditation inspections during the time interval of 2012 to 2017. The well-established laboratory offered a number of products to the broader community, which included general advice on drugs and drug testing. The laboratory also performed prohibited substance confirmation tests for all schools in Pretoria at no cost below the limit of twenty analyses per school.

<sup>4</sup> BioFISA is a Finnish—Southern African Partnership Programme to strengthen the New Partnership for Africa's Development (NEPAD)—Southern Africa Network for Biosciences (SANBio).

- A further example, under the leadership of Prof Maharaj, was collaboration with indigenous communities through research on their medicinal plants leading to products for commercialisation and agro-processing opportunities.

Funding from the NRF and the DST was obtained for the community projects and the establishment of a community pre-processing facility for medicinal plants, and for further research to prove the safety and efficacy of medicinal plants.

## 6. Consumer and Food Sciences

The Department of Consumer and Food Sciences is a relatively new department, formed out of the merger, in 2017, of the departments of Consumer Science and Food Science.

The new department combined the respective strengths of the previous departments: the strong research focus and reputation of the postgraduate programme in Food Science; and in Consumer Science, the excellent undergraduate programmes with linkages to industry, and a strong textile programme.

The Head of Department of Consumer Science, Prof Elmarie (HM) de Klerk, retired in 2014 after a 15-year term. Prof Alet (AC) Erasmus was appointed as the new Head of Department until her retirement in November 2017, which coincided with the merger of the two departments. Prof Amanda (A) Minnaar, Head of Department of Food Science (2001–2012), was succeeded by Prof Elna (EM) Buys. Prof Buys was appointed as the new Head of Department of the merged Department of Consumer and Food Sciences in November 2017.

The strong research-based postgraduate programme of the new Department has attracted master's and doctoral students from across sub-Saharan Africa, many of them university lecturers. Countries represented in the postgraduate student cohorts have included Botswana, Ghana, Kenya, Lesotho, Malawi, Namibia, Nigeria, Swaziland and Uganda, as well as South Africa. In addition, over the years the two departments have fostered research collaborations with a number of local and international institutions. Graduates have become leaders in the South African food, hospitality and clothing industry.

The appointment of extraordinary professors and lecturers further contributed to research and teaching capacity.

In 2013, two new programmes were introduced: the BSc Nutrition and BSc Culinary Science replaced the BSc in Nutrition and Food Sciences and the BSc Food Management qualifications.

## Highlights of achievement

The Department was successful in obtaining funding for projects, which included:

- FOCAL, a project funded by the Bill and Melinda Gates Foundation that focused on mapping foodborne disease surveillance, prevention and control.
- SANBio—BioFISA<sup>4</sup> II project, 'Healthy SMA2RT' snacks for climate-smart crops, a Southern Africa Network for Bioscience (SANBio) project that addresses the demand for 'Safe, Market ready, Acceptable African, Ready-to-eat/use, Trendy' (SMART) healthy snack foods.
- LEAP-Agri, a long-term European Union—Africa research and innovation partnership on food and nutrition security and sustainable agriculture.
- USAID Feed the Future Innovation Labs for food processing and post-harvest handling.

Members of staff had the opportunity to take research leave during the review period. Prof John (JRN) Taylor was awarded a Curtin University fellowship (Australia), and spent time at that university in 2013 and 2014. Prof Buys received a research fellowship from the University of Valencia (Spain) in the Faculty of Pharmacy with Prof Jordi Mañes (2011–2012). In 2018 she was appointed as a research fellow at Curtin University, Australia. Dr Gerrie (GE) du Rand visited Iowa State University (ISU, US) in 2013 as a visiting scholar, and an institutional agreement between UP and ISU was signed in April 2011.

Further achievements included:

- The appointment of Prof Riëtte (HL) de Kock as Research Chair of the European Sensory Network.
- The election of Prof John Taylor as fellow of the International Association for Cereal Science and Technology (ICC) in 2011, and as Honorary (Life) President of the ICC in 2014.
- Prof Taylor was also the recipient of the UP Exceptional Academic Achievers' Award. He was the organiser of the International Sorghum in the 21st Century Conference, held in Cape Town in April 2018.
- Profs John Taylor and partner Janet (J) Taylor patented the process for producing protein microparticles (2011).
- Prof Amanda (A) Minnaar received an award from the European—South African Science and Technology Advancement Programme (ESASTAP) for her contributions to capacity development (2012).

- Prof Buys received a Lifetime Merit Award from the South African Society for Dairy Technology (2014).
- Prof Naushad (NM) Emmambux was a recipient of UP's Young Exceptional Achievers' Award (2014).
- Prof Minnaar was elected as President of the South African Association for Food Science and Technology (SAAFoST) (2015).
- Prof De Kock received the DST Distinguished Woman Scientist Award in recognition of her outstanding contribution to research and innovation for her SANBio—BioFISA II Healthy SMA2RT snacks from climate-smart crops.

## 7. Geography, Geoinformatics and Meteorology

Prof Hannes (CJdW) Rautenbach was at the helm of the Department of Geography, Geoinformatics and Meteorology (GGM) at the start of the review period and concluded his tenure in 2014. He was succeeded by Prof Paul (PD) Sumner, followed, in 2018, by the appointment of the first female Head of Department, Prof Serena (SM) Coetzee.

The three disciplines were reflected in distinct degree programmes with research and teaching activities coordinated through discipline-specific sections. The Unit for Geoinformation and Mapping (UGM), led by Ingrid (I) Booysen until her retirement in 2018, provided geospatial information and cartographic services to students and staff across all faculties at UP.

In 2009, the staff profile was skewed towards junior levels, with only one or two full professors at any given time (and none in 2015). The number of staff with PhDs steadily increased from around 50% in 2009 to 70% in 2018. Just under a third of staff members had an NRF rating, and in 2016, Prof Willem (WA) Landman became the first B-rated staff member. Despite its young staff profile, the Department steadily increased its research involvement and impact, both nationally and internationally.

### Programmes and modules

Undergraduate programmes in Geography, Environmental Science, Geoinformatics and Meteorology were offered through the Faculty of Natural and Agricultural Sciences (NAS). Students enrolled in the faculties of Humanities and Education could also select Geography as a major. A significant part of the undergraduate Geoinformatics programme comprised

Informatics modules offered by the Engineering, Built Environment and Information Technology (EBIT) Faculty. Postgraduate programmes in Geography, Geoinformatics, Meteorology, Environmental Management and Environment and Society were offered through NAS. Doctoral and master's degrees in Geography, and in Environment and Society, were also available through the Faculty of Humanities. This blend of disciplines, ranging from the social sciences to information technology in a single department is unique in South Africa.

The BSc Geoinformatics and BScHons Geoinformatics programmes were accredited by the South African Geomatics Council (SAGC) for the first time in 2012 and again in 2016. Accreditation makes professional registration with the SAGC possible. Ongoing curriculum development resulted in the BScHons Meteorology complying with the World Meteorological Organization (WMO) Basic Instruction Package for Meteorologists (BIP-M).

Since 2011, modules in Environmental Science and Geography were available in programmes in the Faculty of Education, leading to a significant increase in student numbers and an accompanying teaching challenge. Apart from the fact that class sizes abruptly changed from around 100 up to 500 and more, the admission requirements for Education students were significantly different to those for students in the NAS Faculty.

In addition, the #FeesMustFall movement in 2015 to 2016 brought many teaching challenges.

The Department continued its strong collaboration with the South African Weather Service (SAWS), supported through a memorandum of understanding. SAWS provided bursaries to most BScHons Meteorology students and its staff presented several modules at honours level. The Enterprises UP Certificate Programme in Weather Forecasting, required for working as a SAWS forecaster, was offered to SAWS staff members every year.

### Community engagement

The most extensive community engagement initiative was, since 2015, led by Dr Victoria (V-J) Rautenbach. Final year BSc Geoinformatics students mapped the Alaska informal settlement in the eastern part of Mamelodi. Two student projects won national awards and two further projects were selected as finalists. In 2018, Dr Rautenbach received the UP Community Engagement Award for her work.

The Department also hosted the Faculty's first anti-discrimination event in 2017 to celebrate the role of women in science on behalf of the Physical Sciences cluster of the Faculty.

### Research highlights

In Geography and Environmental Science, research covered a wide range of topics, from rock weathering, soil erosion and plant-landform interactions to land reform and human settlements. When Prof Greg (GD) Breetzke joined the Department in 2016, geospatial analysis of crime and health was added to the mix. Systematic and regional approaches were undertaken in a variety of study locations both locally and internationally; for example, Dr Natalie (NS) Haussmann's project on burrowing mammals and Dr Nerhene (NC) Davis's participation in the Parliamentary Review for South African Land Reform, headed by former president Kgalema Motlanthe.

Geoinformatics research focused on geographic information and technology, and their application in fields such as geomorphology, health, crime and forensic analysis, while some researchers focused on remote sensing applications, for example, in agriculture and natural resource monitoring. Further research focused on the visualisation of geographic information to support decision-making and on the ever-increasing volumes of geographic information and the challenges of making these available, accessible and usable. A focus was on geodesy, an extremely scarce skill in the country at the time.

Meteorology research had a focus on dynamical processes. In 2013, Dr Liesl (LL) Dyson completed her PhD on atmospheric thermodynamics and circulation related to rainfall in Gauteng. Dr Thando (T) Ndarana joined in 2017 and contributed to the understanding of dynamical processes that underlie rain bearing synoptic weather systems affecting South Africa. In 2016, Prof Willem Landman brought with him a seasonal forecasting capability, producing rainfall and temperature forecasts for the Southern African Development Community (SADC) region, global sea-surface temperature forecasts including El Niño-Southern Oscillation (ENSO) forecasts, and applications forecasts. The meteorologists expanded their international involvement during this period.

A number of extraordinary appointments contributed to research, postgraduate supervision and the teaching of postgraduate modules. Most of those appointed were involved in meteorology, the Centre for Environmental Studies

### Centre for Environmental Studies

Located in the Department of Zoology and Entomology, the Centre for Environmental Studies (CFES) coordinated two course-based master's and two doctoral degree programmes in the Department of Geography, Geoinformatics and Meteorology. In the latter years of this review period, the Head of Department, Prof Paul Sumner, also served as Acting Director of the CFES.

In 2015, CFES was invited to participate in a Brazil, Russia, India, China and South Africa (BRICS) Network University initiative towards facilitating university partnerships and exchanges across the five BRICS countries. During Prof Sumner's tenure, two BRICS workshops were hosted and attended by visiting scholars from Russia, and in turn, three staff members of the Department — Dr Davis, Michael (MJ) Loubser and Prof Breetzke — together with postgraduate students, participated in exchange visits to different parts of Russia.

### Centre for Geoinformation Science

Established in 2012, and led by Prof Serena Coetzee, the Centre for Geoinformation Science (CGIS) served as an internal platform in support of research, education and training, professional development and community engagement. Extensive collaborations locally and internationally led to productive research initiatives and various opportunities for students, such as international co-supervision of a doctoral student, student exchanges, and joint summer/winter schools in Karlsruhe (Germany).

YouthMappers, funded by the US Agency for International Development (USAID), is a global network of student-led chapters that participate in and organise mapping activities. The UP YouthMappers chapter, hosted in CGIS, was one of the inaugural chapters in 2016, and one of our students participated in a YouthMappers Leadership Fellows workshop in Kathmandu (Nepal), in 2017. CGIS members chaired two Commissions of the International Cartographic Association (ICA), leading to an international workshop on collaborative data custodianship and cloud mapping at UP in 2018.

Dr Victoria Rautenbach was actively involved in the International Society on Photogrammetry and Remote Sensing (ISPRS) working group on Geovisualization, Augmented and Virtual Reality. She was elected to the Board of Directors of the Open Source Geospatial Foundation (OSGeo) in 2018, while Prof Coetzee had represented OSGeo in the UN Open GIS initiative since 2016. In 2018, CGIS became a member of the Academic Network of the United Nations Committee of Experts on Global Geospatial Information Management (UN GGIM). Locally, Prof Coetzee represented the Council on Higher Education on two statutory bodies, the South African Committee for Spatial Information (CSI), and the South African Geomatics Council (SAGC).

CGIS continued its extensive involvement in standards development through the International Organization for Standardization (ISO), the South African Bureau of Standards (SABS) and the Open Geospatial Consortium. For many years, CGIS was the only OGC member from Africa. Prof Serena Coetzee chaired the ISO/TC 211 Program Maintenance Group (PMG) since 2008, initiated the development of the ISO 19160 suite of addressing standards in 2008 and led the development of ISO 19160-1, which was published in 2015. Dr Antony (A) Cooper was convenor of Working Group 7, Information Communities, and Dr Victoria Rautenbach chaired the ISO/TC 211 Advisory Group on Outreach until 2017. The three also actively contributed to the development of South African standards.

### The Laboratory for Atmospheric Studies

Established in 2015, the Laboratory for Atmospheric Studies (LAS), in association with Eskom and Sasol, is a national research facility for sustainable air quality. Prof George (GD) Djolov headed LAS, supervised numerous postgraduate students, and completed many projects, before his sudden passing in November 2017.

In 2015, UP awarded an honorary doctorate to the renowned Boundary Layer Meteorologist, Sergej Zilitinkevich, from Moscow State University (Russia).

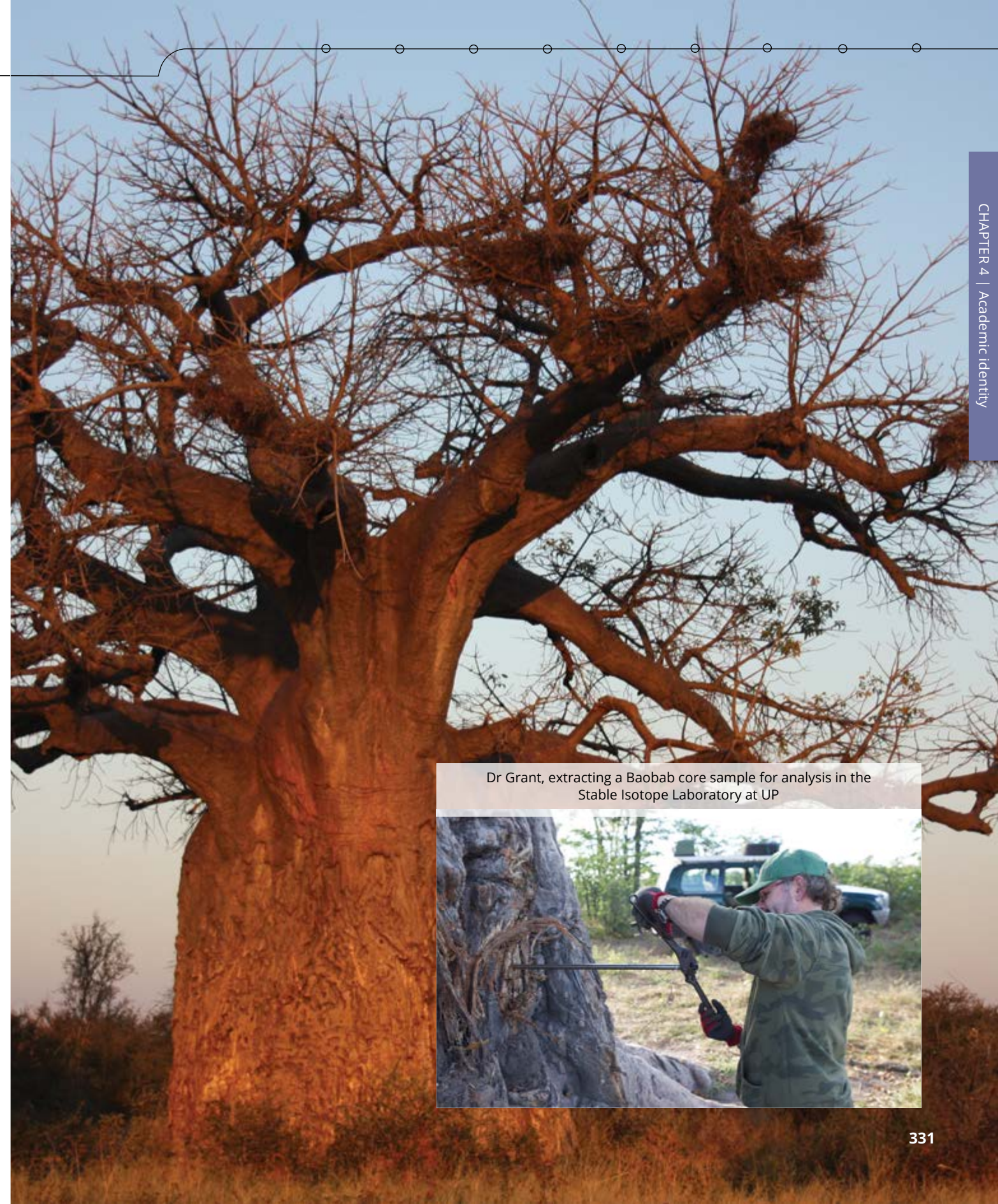

Dr Grant, extracting a Baobab core sample for analysis in the Stable Isotope Laboratory at UP



(CFES) and the Centre for Geoinformation Science (CGIS). Students were supported with bursaries and internships offered by the employers of those in extraordinary appointments, which included the CSIR, HartRAO, SAWS, the South African National Space Agency (SANSA) and the Agricultural Research Council (ARC).

## 8. Geology

During the years 2009 to 2018, the Department of Geology saw a rapid turnover in departmental leadership. Prof Patrick (P) Eriksson, Head of Department from 2006 until he retired in January 2014, was succeeded by Prof Annette (A) Goetz who joined the Department in November 2014. In the interim 10 months, Prof Louis (JL) van Rooy was appointed as the Acting Head. When Prof Goetz returned to Europe to take up a position at Keele University (UK) in June 2015, Prof Wlady (W) Altermann took over the reins, first in an acting capacity and then as Head of Department until September 2018, a few months ahead of his retirement. Prof Adam (AJ) Bumby was appointed in an acting capacity until his appointment as Head of Department in June 2019.

### Research areas

The largest change in focus was the addition of Prof Andrzej (A) Kijko and Dr Ansie (A) Smit to the Department in 2009, to establish the Aon Benfield Natural Hazard Centre Africa, a five-year partnership between Aon Benfield, a leading reinsurance intermediary, and the University of Pretoria. In 2013, it was remodelled into a multi-partnership centre and renamed the UP Natural Hazard Centre (UPNHC).

The Centre's main focus remained the mathematical modelling of natural hazards and risks facing South Africa, Africa and the world. From its inception in 2009 to 2018, the UPNHC published more than 33 peer-reviewed national and international research articles in accredited journals, and chapters in two books. Staff also supervised and co-supervised over 25 postgraduate students, worked with various academic departments at UP and participated in international collaborations.

In 2018, a paper co-authored by Prof Kijko and Ansie Smit, was awarded the prestigious Herbert Sichel medal for best statistics paper at the annual South African Statistical Association's conference.<sup>5</sup> The paper was published in *Pure and Applied Geophysics*, and Ansie Smit was awarded a doctoral degree in relation to this work in 2019.

Industrial-based support continued during this time from Kumba and Exxaro mining companies, who supported Prof Altermann as the Kumba-Exxaro Chair in Geodynamics. Research focused mainly on the tectonic setting of iron deposits in the Transvaal basins in South Africa. Prof Altermann was also instrumental in setting up a new focus on carbon capture and storage (CCS) from 2012 onwards, with the CCS working group conducting research on various geological approaches to store anthropogenic CO<sub>2</sub> and reduce carbon emissions to the atmosphere.

This area of research highlighted a shift in focus away from mainstream geology to more environmentally-based geology, also complemented by the ongoing research into groundwater and engineering geology. In 2016 Dr Roger (RE) Diamond joined the Department to teach and research topics relating to groundwater flow and contamination. Zakhele (ZH) Nkosi joined the staff in September 2018 and continued Prof Altermann's legacy with his PhD research focusing on the topic of carbon capture and storage.

The Stoneman laboratory facilities were also improved during the tenure of Prof Altermann by the addition of 'Selfrag' mineral separation facilities (to date the only one in Africa). As a consequence of this addition, the Stoneman facility now offers world-class mineral separation facilities.

### Curriculum change

The curriculum changed considerably during this review period, from a system with double course loads in the second year, to a more streamlined curriculum with greater emphasis on full semester modules (rather than quarter modules). The variety of first-year quarter-courses were also replaced by semester modules; in the first semester, Introductory Geology, followed in the second semester by Earth History, with a particular focus on the stratigraphy of southern Africa.

In second year, the more complex and demanding courses, Structural Geology and Groundwater, were moved to the third year, so that second-year students could focus on Mineralogy and Sedimentology in the first semester, followed in the second semester by Igneous and Metamorphic Petrology.

In 2010, Dr Nils (N) Lenhardt joined the Department, first as a postdoctoral researcher, and a year later, he was appointed as a lecturer. With his appointment, research and teaching in Volcanology was added to the Department's curriculum.

Following the recruitment of Dr Lorenzo (L) Milani in 2018, a full semester of Economic Geology formed the final semester

<sup>5</sup> <https://doi.org/10.1007/s00024-017-1564-4>

of the third year, running in parallel with a full semester in Engineering Geology for those intending to graduate with an Engineering and Environmental Geology degree. The choice of elective modules that were open to Geology students were also more tightly constrained in this new curriculum, thereby encouraging students to graduate with a joint degree in another physical science.

### UP Natural Hazard Centre

As noted in the Department of Geology text, in 2009 Prof Andrzej (A) Kijko and Ansie (A) Smit were appointed to establish the Aon Benfield Natural Hazard Centre Africa, a five-year partnership between one of the leading reinsurance intermediaries, Aon Benfield, and the University. In 2013, the Centre was remodelled into a multi-partnership centre and renamed the UP Natural Hazard Centre (UPNHC).

The main focus of the Centre has remained the mathematical modelling of natural hazards and risks facing South Africa, Africa and the world. The focus is on calculating the likelihood of natural disasters, and to offer advice and analysis of the potential damage to lives and property.

The Centre also has provided contract research and consultancy services to industry (insurance, construction and mining), and has mostly focused on assessing the hazard and/or risk that a specific area may face due to natural hazards such as earthquakes, tsunamis and hail. These assessments are then used by industry to develop or redesign their products to meet financial, safety and security regulations. The products range from insurance and reinsurance premiums to the development of critical infrastructure such as dams, bridges and nuclear power plants.

The Centre has developed unique methods and computer codes for natural hazard and risk assessments. Unlike the standard techniques that rely on complete datasets, the approach allows for the assessment of natural hazards when data are incomplete and uncertain. The methodologies and computer codes developed in the Centre have been applied internationally, with some being recommended by international regulatory bodies. For example, the methodology by Kijko and Smit (2012)<sup>6</sup> was accepted into the International Atomic Energy Agency (IAEA) Safety Reports (2016)<sup>7</sup>, as one of the recommended techniques to assess parameters in seismic hazard assessment for nuclear facilities and nuclear waste repositories in areas of typical intraplate seismicity.

<sup>6</sup> A Kijko and A Smit. 2012. Extension of the Aki-Utsu b-value estimator for incomplete catalogs. *Bulletin of the Seismological Society of America*, 102(3), pp.1283-1287. <https://doi.org/10.1785/0120110226>

<sup>7</sup> IAEA. 2016. *Diffuse Seismicity in Seismic Hazard Assessment for Site Evaluation of Nuclear Installations*. Series No. 89.

### Exxaro Chair in Geodynamics

The Kumba-Exxaro Chair in Geodynamics was first established in the Department of Geology in 2000 to develop an MSc programme in Earth Science Practice and Management, together with Kumba Iron Ore. By 2009, when the programme was no longer offered, the funding was instead devoted to the Kumba-Exxaro Chair in Geodynamics. The incumbent was Prof Wlady Altermann from 2009 until his retirement late in 2018. During this period, funding was primarily used to host international expertise to deliver short courses on a variety of geological topics within UP. These courses were also open to UP guests from the mining industry.

The Chair was also used to support numerous annual field trips for postgraduate honours students to the Thabazimbi iron ore deposit, the Vredefort meteorite impact site in the northern Free State and to the Barberton greenstone belt in Mpumalanga. The Chair also involved the establishment of new research projects, especially within the focus area of the tectono-stratigraphic evolution of the Chuniespoort Group in the Griqualand West and Transvaal basins, and concentrated in particular on the evolution of the Thabazimbi iron ore deposit. Over time, the funding from Kumba Iron Ore ceased, and the Chair became the Exxaro Chair in Geodynamics.

## 9. Mathematics and Applied Mathematics

The years between 2009 and 2018 were fruitful years for the Department of Mathematics and Applied Mathematics. The Department benefited from strong leadership and striving for excellence that would serve it well in the future. Prof Jean (JM-S) Lubuma steered the ship from 2004 to 2013. He was succeeded by Prof Roumen (R) Anguelov who was appointed as Head of Department in 2013, and re-appointed in August 2017 for a second term. Both Heads of Department were NRF B-rated scientists, and both had received, for a number of years, the UP Exceptional Academic Achiever Award in recognition of their academic contributions. Prof Lubuma also received a South African Mathematical Society (SAMS) award for research distinction in 2011, and in 2014, he was awarded the Sign of Honour of the Bulgarian Academy of Sciences for his contribution to the development and strengthening of research collaboration between the Bulgarian Academy of Sciences and UP.

## Research focus

In 2013 the Department was awarded the first ever SARChI Chair in Mathematical Models and Methods in Bioengineering and Biosciences (M3B2), with Prof Lubuma as the first incumbent. When Prof Lubuma was appointed as Dean of the Faculty of Natural and Agricultural Sciences in January 2016, he was succeeded by Prof Jacek (J) Banasiak as the new Research Chair of M3B2.

The Department remained an environment in which research activities were supported and could flourish. During the review period it played a key role in Faculty priorities for inter- and multidisciplinary research and contributed significantly to UP's long-term strategic plan, UP 2025. Mathematical Biology remained a strategic research focus. Another growing field was mathematics education and mathematics education research at a tertiary level. Further research endeavours included a formal partnership between the Department and the Faculty of Mathematics of the University of Kaiserslautern (Germany), as well as with Government College University of Lahore (Pakistan).

Mathematics and Applied Mathematics maintained a sound publication rate and a high percentage of staff members achieved NRF ratings, complementing the academic standing of its academic leadership. The Department focused on well-defined career paths for its junior staff. Many staff members served on editorial boards of journals. The Department was also involved in many annual competitions to promote mathematics. This included, for example, participation in the South African Tertiary Mathematics Olympiad (SATMO) and the South African Mathematics Team Competition (SAMTC), the organisation of the national UP Mathematics Competition for schools, and the Siyanqoba Regional Olympiad Training Programme.

During the years under review, the Department hosted several conferences and workshops, along with numerous monthly internal research events. The list includes:

- The Second Mathematical Epidemiology Workshop (2010)
- The South African Mathematical Society (SAMS) Conference (2010 and 2016)
- The African Institute for Mathematical Science (AIMS)/ SAMS Satellite Conference on Abstract Analysis (2011)
- The 4th International Conference on Mathematics in Finance (2011)
- The launch of SARChI Chair mini-conference (2013)

- The AIMS-IMAGINARY Exhibition (2014)
- The joint UNISA-UP workshop on Theoretical and Mathematical Epidemiology (2014)
- The International Conference on Mathematical Methods and Models in Biosciences (Biomath-S, 2015, and Biomath, 2017)
- The 39th Symposium of Numerical and Applied Mathematics (SANUM) (2015)
- The 2nd Joint University of South Africa (Unisa)-UP Workshop on Theoretical and Mathematical Epidemiology (2015)
- The Analysis and Differential Equations with Applications to Natural Sciences (ADEANS II) Conference (2018)
- The workshop on Research Trends in Mathematical Modelling and Analysis in Life Sciences (October 2018).

## Highlights of achievement

Awards and achievements that were celebrated in the Department included the Education Innovation Award in 2010 for the Maths Plus Project, the establishment of the first Student Chapter of the Society for Industrial and Applied Mathematics (SIAM) in South Africa in 2014, and the Faculty Award for the best first-year lecturer received by Dr Harry (H) Wiggins in 2018.

The Department's students were often recognised as achievers on the international stage. A further notable achievement was the launch of the teaching and learning bulletin in 2018, the T&L@NAS Bulletin, by Dr Rory (R) Biggs with assistance from Dr Ina (I) Louw.

The exceptional commitment of staff in the Department, commended on several occasions by independent peer-reviewed systems, is illustrated by the fact that the average weight of the teaching and learning activity on the annual duty allocation for lecturing staff ranges from 65% to 75%. Over and above the proactive approach to constantly realign departmental priorities and the evaluation of the undergraduate and postgraduate programmes, the Department ensured optimal teaching conditions, which included the appointment of student advisors, the implementation of an early intervention system in students' first year of study to identify and support those at risk, the use of orientation week diagnostic tests and mid-year re-orientation, the monitoring of tutorial attendance, and the use of calculus readiness tests for mainstream Engineering students.

## 10. Physics

Prof Johan (JB) Malherbe, Head of the Department of Physics, retired at the end of 2011 and was succeeded by Prof Chris (CC) Theron in 2012. Prof Malherbe remained actively involved with research in the Department and was also Head of the Laboratory for Microscopy and Microanalysis.

### New areas of focus

Two new focus areas were developed during the review period, the first was in Biophysics and the second in Astronomy.

Prof Tjaart (TPJ) Krüger has led the development of Biophysics at UP. He has made new developments to single molecule spectroscopy and was awarded a National Nanotechnology Equipment Programme (NNEP) grant to build a unique setup, which he has applied mainly to photosynthetic light-harvesting complexes. His research aligns with the institutional, national, continental and global research priority of energy and sustainability and also ties in with bioeconomy in the context of agriculture, including ideas for developing high-light-tolerant or drought-tolerant crops. Another niche is in the area of ultrafast pulse shaping applied to photosynthetic light-harvesting complexes. He has managed

to build strong international links and is recognised as one of the main drivers of the single molecule spectroscopy technique.

In earlier years, there was not a strong focus on Astronomy at UP, except for a general first-year course that was aimed at students with a science background. However, given the national focus on developing Astronomy in the era of the Square Kilometre Array (SKA), it was clear that Astronomy had to be grown at UP. Prof Roy (RS) Booth, emeritus professor at the University of Chalmers, Gothenburg (Germany) was appointed to develop an undergraduate curriculum and spearheaded the search for a suitable individual to lead research in very large baseline interferometry (VLBI). With the help of Dr Henry (HB) Throop, who was in Pretoria at the time, the first courses were designed and offered to students. Dr Throop, a part-time appointee in the Department, was also involved in the New Horizons mission to fly by Pluto and gave numerous talks to the public when the first results came out in 2015.

The Physics programme was enhanced by the offering of three new elective modules focusing on Astronomy and Particle Physics: a second-year module in Astronomy (PHY 210), a third-year module in observational techniques for Astronomy (PHY 300), and a theoretical introduction in the



mathematical techniques needed for the study of Astro- and Particle Physics (PHY 310).

In 2018, Prof Roger (R) Deane was appointed, and due to his membership of the Event Horizon Telescope consortium, would go on to share the 2020 Breakthrough Prize in Fundamental Physics for the first images of a black hole.

### Improvements to infrastructure

Major improvements in the Department's ability to provide laboratory practicals and small group tutorials were made. The extremely large and open laboratory space on the third floor of the Natural Sciences II Building where the Department of Physics is located, was divided into eight smaller units, making it possible to deal effectively with 240 students in a single session. Linked to this renovation was the building of eight flat room tutorial venues, where students would be able to work on solving problems in small groups. This project was initiated in 2017 and it was anticipated that building would be completed by the end of 2019. These investments would facilitate learning with large groups of students implementing best practices in Physics learning and allowing the Physics Department to meet the growth requirements in Engineering and Medical student intakes.

### Specialist areas and research chairs

Theoretical Physics is driven in the following areas: Mathematical Physics, Prof Rocco (R) Duvenhage, with a focus on quantum dynamical systems, using an operator algebraic setting; Nuclear Physics, Prof Sergei (SA) Rakitianski; High Energy Physics, Prof Costas (K) Zoubos, mostly focused around the AdS/CFT correspondence; and Computational Physics, Prof Nithaya (N) Chetty.

In Computational Physics the focus continued to be on two-dimensional systems such as graphene and other graphene-related materials such as boronitrene and molybdenum disulphide. In Experimental Physics the focus was on the growth and characterisation of semiconductors as well as semiconductor devices. The unique feature of the group has been the extensive expertise in Laplace deep-level transient spectroscopy (L-DLTS) and the installation of the first molecular beam epitaxial growth system for III-V (GaAs based) semiconductor growth in the country. This was the result of a successful 'noise-equivalent power' (NEP) application by Prof Chris Theron and Prof Walter (WE) Meyer.

The work by the Nuclear Materials Group, under the leadership of Prof Johan Malherbe and Prof Thulani (TT) Hlatshwayo, focused initially on the suitability of materials for the pebble bed modular reactor (PBMR) programme, but later started evaluating materials for their application in nuclear waste storage.

### Research chairs

Two SARChI chairs were active, namely the Chair in Complex Systems (Prof Pawel (P) Selyshchev), and the Carbon Chair (Prof Ncholu (N) Manyala):

- The work in complex systems has led Prof Selyshchev to suggest that a propagating self-sustained annealing of radiation induced defects could be an effective method for extending the life of nuclear reactor materials.
- The nano carbon research group of Prof Manyala had its prime excellence in the synthesis and characterisation of carbon-based materials (activated carbons, hollow carbon nanostructures), chemical vapor deposition (CVD) graphene, transition metal oxides/hydroxides, phosphates and disulfides for energy storage applications.

A third Chair in Radioastronomy, awarded to the radio observatory HartRAO in Hartbeesthoek in 2018, was created with the expectation that the incumbent would be appointed at UP.

Finally, many staff members were represented on international bodies, the most notable being Prof Chetty who was Vice-President of the International Union for Pure and Applied Physics.

## 11. Physiology

Prof Annie (AM) Joubert was appointed as the first female Head of Department of Physiology in 2014, and built on the leadership of her predecessor, Prof Dirk (DH) van Papendorp (1990 to 2014).

By the end of 2018, the Department of Physiology had a total of 36 staff members — 22 academic and 14 professional staff. The Department teaches approximately 3 000 students per annum, across three campuses — Prinshof, Hillcrest and Hatfield.

The focus is on students and health professionals at undergraduate and postgraduate levels, and those enrolled for bachelor's degrees in the sciences:

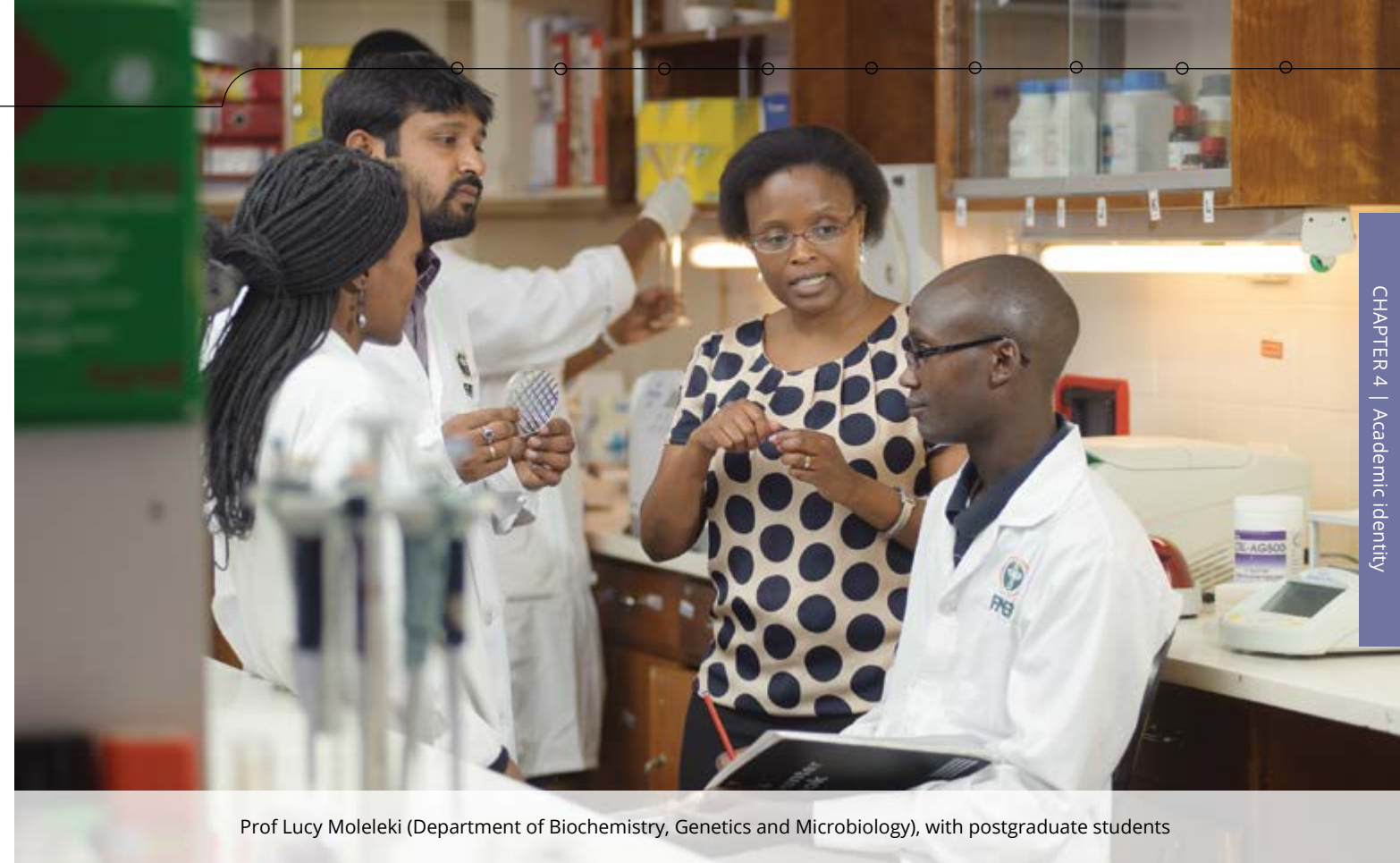

Prof Lucy Moleleki (Department of Biochemistry, Genetics and Microbiology), with postgraduate students

- Human Physiology forms part of a major for two undergraduate programmes that reside in the Department: BSc Human Physiology and BSc Human Physiology, Genetics and Psychology.
- Additional modules include the training of students who study medicine, dentistry, nursing, dietetics, communication pathology, food science, consumer science, occupational therapy, physiotherapy and radiography.
- Students are also trained as biokineticists and sport scientists at undergraduate and postgraduate degree levels. These modules involve the faculties of Health Sciences, Humanities and Natural and Agricultural Sciences.

Postgraduate students in the Department can specialise in neuroendocrinology, sport and exercise physiology, as well as cellular and molecular biology, biokinetics, sport science and biomechanics.

In 2014, the Division of Biokinetics and Sports Science was incorporated into the Department of Physiology. Staff are registered as biokineticists with the Health Professions Council of South Africa (HPCSA).

The Division offers a clinical and practical platform for students in the BSport Sci, BSc(Hons) in Biokinetics, and BSc(Hons) in Sport Science programmes. It is linked to the Sport, Exercise Medicine and Lifestyle Institute (SEMLI), an institute that consists of several platforms, including a Sport Science Unit and a Biokinetics practice which enable professionals in the field to deliver multidisciplinary services to athletes and the public alike.

The new Bachelor of Sport Science (BSportSci) programme, and the postgraduate programmes associated with this programme, reside in the Department of Physiology.

### The approach to teaching

The Department's multidisciplinary approach often included interdepartmental, interfaculty, national and international collaboration by using cross-cutting technologies to prepare students for the work environment. The aim was to address the high burden of disease in South Africa by focusing on both non-communicable and communicable diseases. The Department furthermore aligned its teaching practices to incorporate hybrid and online teaching and learning in line with the University's strategic goals.



The BSc Honours programme in Physiology gained popularity among undergraduate students and increased from 12 students in 2009 to 25 enrolments in 2018. Significant strides were made to adapt teaching and learning to accommodate an increased intake of students from diverse undergraduate BSc degrees.

Further developments included the following:

- Exercise, nutrition and neuroscience modules were implemented at second- and third-year levels.
- The former BA (Human Movement Science, BSportSci, BA(HMS)(Hons) Biokinetics, and BA(HMS)(Hons) in Sport Science programmes in the Faculty of Humanities were phased out.
- The BSportSci, BSc(Hons) in Biokinetics and BSc(Hons) in Sport Science programmes in the Faculty of Health Sciences were phased in.
- The first student intake for the BSport Sci programme was in 2015 whilst 2018 welcomed the first BSc(Hons) in Biokinetics and BSc(Hons) in Sport Science students.
- Additional MSc and PhD programmes in these fields also commenced in 2016.
- The Division of Biokinetics and Sport Science was the first in South Africa to offer a postgraduate qualification in Biomechanics in the form of MSc (Biomechanics) and PhD (Biomechanics) programmes.

### Highlights of achievement

Some of the notable achievements include:

- Academic staff were regularly invited to act as external examiners for postgraduate and undergraduate courses at most South African universities.
- Three staff members received NRF ratings, and one colleague the Next Einstein Fellowship and a UP Exceptional Young Researcher Award.
- Early career researchers also received international travel awards to further develop their careers.
- The first dual PhD was awarded, in 2016, between UP and the Grenoble Alpes University Community in France.

The Department took exceptional pride in its research outputs. Staff were involved as authors or co-authors in a total of 334 papers published in internationally peer-reviewed journals during this period. Research focused on medical science and health practices related to a wide

range of topics from basic science to clinical projects, and thereby contributing to translational medicine in support of community needs and improving health outcomes.

## 12. Plant and Soil Sciences

The Department of Plant and Soil Sciences was created as a consequence of a proposal by Prof Anton (A) Ströh, former Dean of Natural and Agricultural Sciences (2003–2015), to create a new Plant Science and Crop Science entity at the University of Pretoria. The merger followed international trends of bringing together expertise in basic and applied Plant Sciences for greater impact. This decision was approved at the Faculty Board meeting of 11 March 2014, and subsequently by Senate on 22 May 2014. It entailed the merger of two departments, namely the Department of Plant Science and the Department of Plant Production and Soil Science, and the transfer of some Plant Pathology staff from the then Department of Microbiology and Plant Pathology.

Prior to the merger, the Department of Plant Production and Soil Science was led by Prof John (JG) Annandale (2009–2015), and Prof Dave (DK) Berger was Acting Head of the Department of Plant Science from January 2014 to September 2015, following Prof Marion (JJM) Meyer whose term as Head of Department (2001–2013) had come to an end.

### A new complex

In his time as Head of Department, Prof Meyer spearheaded the concept and development of the Plant Sciences Complex, a building which houses not only staff offices, but also state-of-the-art research and teaching facilities. The University of Pretoria was allocated infrastructure funding of R170 million in 2009 by the Department of Higher Education and Training to support primarily the expansion of the University's School of Engineering. The infrastructure development grant also included the building of new facilities for the Department of Plant Science. Following approval by the University Council that the additional costs would be covered from University funds, the building of the Plant Sciences Complex commenced in January 2010 and the R100 million facility was officially opened on 17 January 2012 by the Vice-Chancellor, Prof Cheryl de la Rey.

The various research focus areas of Plant Sciences were moved to this complex with research laboratories that were designed for research in fields such as plant biotechnology, diversity and ecology, as well as in medicinal plant science.



Three of the large exterior walls of the new building (consisting of natural rock) were designed to make use of natural vegetation to cool the building and shade it from the sun. These 'green walls' consist of indigenous flora and are therefore a living experiment. A number of other energy-efficient design principles were implemented, including natural ventilation through the use of chimneys to extract warm air, thereby reducing the load on air conditioning systems that consume vast amounts of energy. Rainwater is also harvested from the glass roof and used in the greenhouses located on the roof.

### Leadership

Prof Nigel (NP) Barker was appointed as Head of the newly formed Department of Plant and Soil Sciences, and assumed duties on 1 October 2015, with the new name of the Department ratified at the Senate meeting of 29 November 2015.

The Department comprised over 30 academic staff, and teaching and research were aligned in six main subject areas: Crop Production (which includes Agronomy, Horticulture and Pasture Science), Biodiversity, Medicinal Plant Science, Plant Pathology, Plant Biotechnology and Soil Science.

Twenty-two of the staff had NRF ratings, with three staff awarded B-ratings in this review period.

### Research and teaching

The Department hosts the SAFCOL Chair in Forest Science under the leadership of Prof Paxie (PW) Chirwa, the DST-NRF SARChI Research Chair in Plant Health Products from Indigenous Knowledge Systems headed by Prof Namrita (N) Lall, and is co-host of the DST-NRF Centre of Excellence in Food Security, led by Prof Lise (L) Korsten. In addition, Prof Barker was awarded a R13 million NRF Large Equipment grant for the establishment of a Controlled Environment Plant Growth Chamber facility that enables staff to conduct research on plants (especially crops) under future climatic conditions. The relatively recent acquisition of an Aeroponics research facility, and numerous glasshouses and field sites on Innovation Africa@UP (previously known as the Hillcrest Experimental Farm), all contribute to the Department's major research focus on plants for food and medicine.

The Department teaches no fewer than 37 undergraduate courses, and is the academic home of the undergraduate BSc Plant Science, BScAgric (Applied Plant and Soil Science), and BScAgric (Plant Pathology) degrees. Staff also teach in the Extended Curriculum programme at the Mamelodi Campus. At postgraduate level, it hosts four honours degree programmes, six MSc programmes, five MScAgric programmes, and eight PhD programmes.

In the period 2009 to 2018 the Department graduated 182 masters and 72 PhD students from across this range of degree offerings.

### SAFCOL Forestry Research Chair

The SAFCOL Forestry Research Chair was established in 2008 with a R7 million grant from the South African Forestry Company Limited. Located in the Department of Plant Production and Soil Science, the aim was to establish a home for interdepartmental forest sciences and management programmes at the University of Pretoria.

A key premise was the need for the availability of a critical mass of scientists in allied fields, and through collaborative agreements with reputable regional and international institutions, to offer world-class postgraduate degrees in forest sciences in Southern Africa.

Four extraordinary professors were involved in the programme during this period.

With the funding from SAFCOL Forestry, the programme leveraged substantial funding for postgraduate students from the forestry industry. International donor organisations included Mastercard Foundation (US), the African Forest Forum, DAAD scholarships (Germany), the EU-AU-Intra-Africa Academic Mobility Scheme, among others. Students came from a number of countries including seven SADC countries (Eswatini, Malawi, Namibia, South Africa, Tanzania, Zambia and Zimbabwe), West Africa (Benin, Nigeria), and East Africa (Ethiopia, Kenya, South Sudan). Between 2009 and 2018, twenty-four students graduated, including four PhDs. Additionally, 69 scientific papers and eight book chapters were published in internationally recognised journals.

## 13. Statistics

Prof Nico (NAS) Crowther remained at the helm of the Department of Statistics from 1991 until the appointment of Prof Andriëtte (A) Bekker in July 2012, the first female Head of the Department of Statistics at UP.

The Department is unique in that it straddles two faculties, the Faculty of Natural and Agricultural Sciences (NAS), and the Faculty of Economic and Management Sciences (EMS).

In the period 2009 to 2018, the Department continued to present mainstream programmes in both faculties at undergraduate and postgraduate levels. It also continued with its support teaching, which included non-mainstream statistics programmes and modules in several faculties, ranging from introductory to advanced levels.

The Department is the largest of its kind in South Africa with a module enrolment of 11 440 students in 2018. Apart from a complement of 30 full-time staff, there were also eight extraordinary appointments of global leaders who contributed substantially to the knowledge capacity of the Department. These appointments enhanced the international footprint of the Department and facilitated the development of globally competitive teaching programmes and research focus areas. An important outcome was that students experienced an enriched global perspective of the discipline through joint teaching activities, guest lectures and seminars.

### Service, teaching and research

There were several service, teaching and research activities in the period under review that distinguished the Department of Statistics. The Internal Statistical Consulting Service (ISCS) continued to render campus-wide quantitative research support to doctoral students and to the broader research community within the University. The Bureau for Statistical and Survey Methodology (STATOMET) was realigned to incorporate additional platforms through which research are conducted, performed and organised.

In addition, research platforms provided research facilitation and financial support, and directed research activities in the Department. These included:

- SARChI Chair in Computational and Methodological Statistics, established in 2011
- SARChI Chair for Biostatistics (2018)
- Statistics HUB (2013)
- Centre for Artificial Intelligence Research in Statistics (STATS@CAIR).

Research endeavours were organised in synergy with the broader research goals and focus of the Department.

The DST-NRF Centre of Excellence in Mathematical and Statistical Sciences (CoE-MaSS), established in 2014 and hosted by the University of the Witwatersrand (Wits), coordinates and funds mathematical and statistical research at a national level. In the period under review, the UP Department of Statistics successfully delivered two funded projects:

- Teaching statistics with the data science paradigm, and
- The seasons of statistical learning and statistics.

The Statistics HUB, located in the Department, offers internships to students in cooperation with development partners. The offers include substantial study bursaries to successful candidates selected on a competitive basis. The bursaries are for full-time postgraduate study in the Department. The internship initiative also offers candidates an opportunity to gain work experience in industry or in academia, and facilitates the development of a diverse spectrum of candidates for future careers. Linked, and through a partnership with the SAS (Statistical Analysis System) Institute, undergraduate, honours and master's students can obtain SAS certification which enhances student employability, specifically within the SAS software ecosystem.

In 2019 the Department of Statistics was to host the International Symposium in Statistics and Biostatistics. The symposium, with its particular focus on computational and methodological statistics and biostatistics, would be the first of its kind in recent times on South African soil.

Between 2009 to 2018, the research output of the Department of Statistics, measured in articles published in accredited journals, increased from 5,16 to 18,22. At the same time, the average module pass rate at the level of undergraduate modules improved from 66,8% in 2012 to 77,95% in 2018.

The Department was one of the first to invert traditional teaching models and to adopt Clickers in flipped classroom teaching environments alongside the implementation of MindTap to optimise active learning in the classroom.

### Social and professional responsibility

The Department contributed towards fulfilling its social and professional responsibility through many activities which engaged the broader community. WYSUP 2013 was a statistics awareness campaign, demonstrating the importance of Statistics as a subject that contributes to many fields and to our day-to-day activities. The campaign was launched in part to celebrate the International Year of Statistics in 2013. It included a visual competition 'Unexpected Statistics', and concluded with a gala event attended by leading statistics community members, business and government executives, and members of the UP Executive.

In 2014 the Department celebrated the centenary year of Statistics in South Africa. The statistical profession was promoted through social engagement and campaigns, such as the 'Statistics Awareness amongst Mathematics Teachers and Learners' event held in 2017.

Also in 2014, the Department's office layout was changed to include a postgraduate facility. The new spaces created a conducive study atmosphere for individuals and group work.

### Programme and qualification changes

Big data, machine learning and data science have significantly influenced the expansion of statistical methodology. Keeping programme composition, module content and modes of delivering at the forefront, the Department regularly restructured, reviewed and realigned programmes and modules. Specific initiatives started in 2014 to align undergraduate and postgraduate teaching with data science, to include algorithmic thinking and statistical computation orientated teaching. These approaches were aimed at preparing students for a changing workplace, and to embrace the challenges of the Fourth Industrial Revolution.

The Department, as a national consortium member, hosted the MSc e-Science programme which is part of the DST-funded National e-Science Postgraduate Teaching and Training Platform (NEPTTP). The aim is to train postgraduate students in computational, mathematical and statistical methods to solve data-driven problems. Started in 2018, the programme creates opportunities for students interested in interdisciplinary perspectives and the emerging field of data science to combine specific subject-related knowledge with the latest trends in data analytics.

### The Bureau for Statistical and Survey Methodology

The Bureau for Statistical and Survey Methodology (STATOMET), was established in the Faculty of Economic and Management Sciences (EMS) in 1992. Since 2000, STATOMET has been located in NAS as a Bureau within the Department of Statistics.

STATOMET provides efficient high-quality services in data analytics and the application of statistics to big data problems. The focus is on contemporary and cost-effective solutions driven by a team of experts in statistics, statistical and machine learning and data science. Staff are dedicated to assisting organisations in understanding their data and applying analytics to various disciplines, which includes marketing, medicine, procurement, risk optimisation and business decision-making. Funds generated by STATOMET are mainly used for academic support by means of bursaries, internships and other research-related expenses.

Since 2009, the Bureau has established links with numerous national and international companies. These include

Lightstone Research, the MTN group, Botswana Life, Liberty Life, HSBC banking and financial services, SARPAM, Kresge Foundation, IQVIA and Potatoes South Africa, to name a few. Dr Sollie (SM) Millard was appointed in 2013 as the Director. During this latter period, significant contributions were made to various companies, especially in addressing risk-based challenges in the telecommunications industry.

## 14. Zoology and Entomology

There were a number of resignations, retirements, new appointments and promotions in the period 2009 to 2018. The Head of Department position was held by Prof Sue (SW) Nicolson (2009–2011), Prof Christian (CT) Chimimba (2012–2016) and Prof Andrew (AE) McKechnie (2016–2017). Prof Mark (MP) Robertson was appointed Acting Head of Department from January to October 2018, until Prof Armanda (DS) Bastos took up the position of Head of Department in November 2018. From 2014 to 2015 Prof McKechnie served as Acting Deputy Dean of Research and Postgraduate Studies in the Faculty of Natural and Agricultural Sciences.

### Facilities and research entities

The Zoology Building, a historic building dating back to 1924, was renovated over a period of one and a half years between 2009 and 2011, at a cost of R15 million. The renovations were made possible by infrastructure development funding received from the Department of Higher Education and Training (DHET). Undergraduate teaching laboratories, research laboratories and staff offices were upgraded. In addition, the Mammal Research Institute (MRI) relocated from the Zoology Building to the newly refurbished ground floor of the Botany Building. Shortly thereafter the Stable Isotope facility transferred from the Council for Scientific and Industrial Research (CSIR) to UP and has been operating from the MRI ever since. In 2018, the MRI expanded further to include staff and students of the former Centre for Wildlife Management (CWM) when it was amalgamated with the MRI. This move was accompanied by the transfer of three academic programmes, linked to the CWM from the Department of Animal and Wildlife Sciences to the Department of Zoology and Entomology. This move back to the academic department in which the CWM was founded, increased the number of research chairs in the Department of Zoology and Entomology, from four to five. They are:

- Chair in Conservation Ecology — Prof Rudi (RJ) van Aarde
- Eugene Marais Chair of Wildlife Management — Prof Michael (MJ) Somers
- Austin Roberts Chair of African Mammalogy — Prof Nigel (NC) Bennett
- SARChI Chair in Mammalian Behavioural Ecology and Physiology — Prof Bennett
- The joint SANBI-UP SARChI Chair in Conservation Physiology — Prof McKechnie.

### Changes in staff

Five full professors retired within the space of a few years (2015–2016), namely Profs Marthan (MN) Bester, Sue Nicolson, Willem (W) Ferguson, Clarke (CH) Scholtz, and Rudi van Aarde. This paved the way for a number of new appointments, including Dr Abdullahi (AA) Yusuf, Prof Adrian (AM) Shrader, Dr Heike (H) Lutermann and Dr Grant (G) Hall. In addition, Ingrid (I) Vis who had worked in the Department for a number of decades retired at the end of 2016 and Vongani (V) Maboko took up the position of secretary in 2017. The entomology focus of the Department was strengthened through two appointments in the Forestry and Agricultural Biotechnology Institute (FABI), viz. Dr Brett (BP) Hurley and Dr Almuth (A) Hammerbacher, and the earlier appointments of Dr Chris (CW) Weldon and Dr Catherine (CL) Sole between 2010 and 2013. Teaching and learning within the undergraduate programmes flourished with the appointments of Dr Carel (CJ) Oosthuizen and Prof Shrader, who both consistently receive NATHouse student nominations for best lecturer for first and senior year courses, respectively.

Prof Elissa (EZ) Cameron resigned as Director of MRI in 2010 and Prof Bester was appointed Acting Director until April 2011, when Prof Robert (RP) Millar took up the helm as the new Director. Prof Millar served in this capacity until June 2016 when he transferred to the Faculty of Health Sciences to take up the directorship of the Centre for Neuroendocrinology. Prof Armanda Bastos initially served as Deputy Director and then as Acting Director from February 2016 until Prof André (A) Ganswindt's appointment as Director of MRI in August 2017. Prof Peter (PB) Best, a world-renowned whale researcher and Director of the MRI Whale Unit, passed away in April 2015. Dr Ken (KP) Findlay took on the directorship until March 2016. The Unit was restructured following his resignation, with Dr Els (E) Vermeulen (research manager), ably assisted by Christopher (C) Wilkinson (technical manager), heading the research activities of the

Unit. Together they continue Prof Best's legacy by carrying out the annual whale counts that are critical to guiding the activities of the International Whaling Commission.

### Highlights of achievement

As a research-intensive department that produces a quarter of the publication output of the Faculty of Natural and Agricultural Sciences, it is not surprising that staff have repeatedly been recognised for their contributions to research excellence through a number of internal and external awards. In addition to having three A-rated researchers in the Department of Zoology and Entomology from 2011 to 2016, viz. Profs Nigel Bennett, Robert Millar and Clarke (CH) Scholtz, staff members were regular recipients of UP exceptional academic achievement awards. Profs Sue Nicolson and Rudi van Aarde received this award in 2009, Prof Andrew McKechnie was a recipient in 2013 and 2016, Prof Marthan Bester in 2014 and Prof Scholtz in 2015. The Chancellor's award for research was awarded to Prof Bennett in 2010 and 2017 and to Prof Nicolson in 2013. Exceptional young researchers recognised by UP included Prof Elissa Cameron and Prof Andrew McKechnie in 2009, Dr Chris Weldon in 2014, Prof Nico (PJN) de Bruyn in 2016 and Dr Brett Hurley in 2017.

External recognition for our academics has come through a number of awards, including the Zoological Society of

Southern Africa's Gold medal award to Prof Sue Nicolson in 2010 and her election as fellow of the Royal Society of South Africa in the same year. In 2018, Prof Rudi van Aarde was awarded the Southern African Wildlife Management Association's Research Excellence Award. Numerous staff members have been finalists and winners of National Science and Technology Forum (NSTF) awards. In 2013 Prof Robert Millar was the recipient of the NSTF-BHP Billiton Award for outstanding contributions to science, engineering, technology and innovation (SETI) over a lifetime and in 2015 Prof Nigel Bennett was recognised for his significant contributions to research capacity development over 10 years. Prof Robin (RM) Crewe was awarded the prestigious Harry Oppenheimer Fellowship Award by the Board of the Oppenheimer Memorial Trust in 2013, and Prof Bob Millar received the same award in 2016.

The MRI commemorated its 50th anniversary in 2016 by hosting a conference in Mopani in the Kruger National Park, which brought a number of world-renowned researchers to the meeting, as well as the two past directors, Profs Johan (JT) du Toit and Elissa Cameron. The Department of Zoology and Entomology was also the proud host of the highly successful joint Entomological Society of Southern Africa (ESSA) and Zoological Society of Southern Africa (ZSSA) meeting which was held at the CSIR Conference Centre in Pretoria in July 2017.



## Mammal Research Institute

The Mammal Research Institute (MRI) in the Faculty of Natural and Agricultural Sciences is dedicated to research and teaching the biology and ecology of African mammals, including the conservation of indigenous mammal fauna in the context of sustainable human development.

MRI is pan-African in its research and training, with activities extending across southern and central Africa to West Africa, Ethiopia and the Southern Ocean. In addition, international collaborations exist on all continents. Established in 1966, it has a rich history in conducting research on the behaviour, physiology, ecology and taxonomy of aquatic and terrestrial mammals. Results-driven research with clear conservation and sustainability objectives has enabled the Institute to provide environmental managers with robust tools for the conservation of indigenous mammal fauna. Basic, applied and interdisciplinary research are conducted under the themes of terrestrial ecology, ecophysiology, wildlife management and conservation, human wildlife interface, and marine mammal ecology.

The research, while principally African in origin, has reached as far afield as Antarctica, Argentina, India and Australia, and researchers have also consulted on a wide range of environmental impact studies.

### Leadership and governance

MRI is managed by a Director and Executive Committee, and guided by a diverse and prestigious Advisory Board.

Prof Elissa Cameron, Director of MRI from 2006 to 2010, was succeeded by Prof Robert Millar in 2011 who remained in this position until 2016. Prof Armanda Bastos served in an acting capacity as Director for the period 2016 to 2017 until the appointment of the new Director, Prof André Ganswindt, in mid-2017.

The excellence achieved by MRI researchers is evident in the numerous long-term collaborations that have been maintained with researchers from all over the world, along with high productivity. MRI has had well over 100 peer-reviewed publications per annum and in excess of 20 postgraduate students who progress annually. Staff, associates and fellows continued to receive many awards and accolades in recognition of their exceptional, high-quality research. Among these are the UP Academic Achievers' Awards and NRF ratings received, and many other accolades.

## Research themes

MRI's research focus is the changing living conditions and biological needs of some of the world's most iconic, intelligent and economically important species that are roaming the planet. The aim is to retain its position as a premier institute for African mammal research and teaching by expanding national and international collaboration networks to create the ideal platform for mammal-oriented research, including theoretical and practical postgraduate training.

The five themes that structure the work of MRI are summarised below:

- Terrestrial mammal ecology

Research in terrestrial mammal ecology has focused on a diverse range of topics including the genetics, taxonomy and systematics, evolution, physiology, diseases and parasites, behaviour, population and community ecology, and conservation of mammals. These studies encompass both pure and applied science that provide scientific advice for their management and conservation.

Species studied range literally from mice to elephants. To date, staff and students have carried out their research in South Africa, Botswana, Chad, Democratic Republic of the Congo, Madagascar, Malawi, Mozambique, Namibia, Rwanda, Swaziland, Tanzania, Zambia, and Zimbabwe. In addition, studies have taken place beyond the African continent in Australia, India, Saudi Arabia and Spain. This diverse theme encompasses research projects from many MRI staff and associates and, since 2018, has been led by Prof Adrian (AM) Shrader with projects involving a number of international collaborators. He is also an Associate Editor for three journals — the *African Journal of Wildlife Research*, *African Zoology*, and *Frontiers in Ecology and Evolution*.

- Ecophysiology

The MRI has been conducting ecophysiology research since 1970, under the auspices of Prof John (JD) Skinner and his associates who investigated the ecophysiology and behavioural endocrinology of large African mammals.

This theme is led by Profs André Ganswindt and Nigel Bennett. Together they have collaborated with approximately 60 international and national researchers as well as actively supervising and mentoring numerous honours, MSc and PhD students along with several postdoctoral and senior research fellows every year. Nearly 100 postgraduate degrees have been attained by students under their leadership.

When Prof Bennett joined the MRI in 1995, he set up a radioimmunoassay laboratory for measuring hormones in plasma and urine samples in a suite of small mammals. He holds a full professorship in the Department of Zoology and Entomology as well as two prestigious positions, the Austin Roberts Chair of African Mammalogy (held since 2006) and the DST-NRF Research Chair in Mammal Behavioural Ecology and Physiology (held since 2007). These two Chairs bring academic prestige to the MRI as well as large numbers of fully funded postdoctoral and postgraduate students who are responsible for a significant contribution to the annual publications of the MRI.

Since Prof Ganswindt joined the MRI in 2009 the field of wildlife endocrinology has been strengthened significantly. He established the Endocrine Research Laboratory as part of a collaborative initiative by the Faculty of Veterinary Science and the MRI. He is also Chair of the International Society of Wildlife Endocrinology, Vice-President of the Zoological Society of Southern Africa and Research Associate of both the Centre of Veterinary Wildlife Studies (UP) and the SANBI National Zoological Gardens of South Africa.

The main areas of interest within the ecophysiology theme are male reproductive behaviour and its endocrine correlates in terrestrial megaherbivores, which includes alternative reproductive tactics, physiological correlates and the impact on wildlife of processes like climate change, land transformation and urbanisation. Of further interest are the welfare aspects related to wildlife management as well as the population dynamics of and environmental, micro-climatic, physical, social and reproductive challenges experienced by the Bathyeridae (African mole-rats) that live exclusively underground.

- Wildlife management and conservation

Teaching and research on wildlife management and conservation at the University of Pretoria has been running under the umbrella of the Eugène Marais Chair of Wildlife Management for 50 years. This theme is co-led by Prof Michael (MJ) Somers and Dr Mark (M) Keith. There are several MRI fellows who are also associated with the wildlife management theme; among them, Prof Matt (MW) Hayward, Dr Jan (JA) Venter, and Dr Harriet (HT) Davies-Mostert.

The commitment is to developing a greater understanding of wildlife, and the management and conservation thereof, through the training of scientists and the pursuit of primary research in aspects of wildlife biology. Through the MRI and the Department of Zoology and Entomology, a number of courses have been offered. Hundreds of graduates have

progressed through these courses, many of whom now hold important positions in conservation in South Africa and abroad.

The BSc(Hons) Wildlife Management programme, although about managing wildlife, is primarily an honours degree that teaches students how to be scientists. The primary aim is therefore to teach students how to conduct research and make decisions as to how, for example, vegetation should be managed to maintain wildlife populations. It teaches students quantitative population dynamics skills to manage animal numbers for whatever purpose (e.g., harvest or conservation). The course therefore has much plant-related work, some mathematics, statistics and other scientific skills.

Both the MSc and PhD in Wildlife Management are research-based and done on topics of interest to the students and academics. Owing to diverse needs and interests, the research mostly relates to how animals adapt to changing landscapes, pest management (rodents), livestock predation, and how managed animals adapt to new environments (invasion biology) or environments they have been reintroduced to (reintroduction biology).

- Human-wildlife interface

The human-wildlife interface theme engages in interdisciplinary research that applies social science theories and methods to understand and manage wildlife conservation issues. The causes of human-wildlife conflicts are investigated, and research is conducted with key stakeholders to determine which policy, management or economic interventions could help to mitigate such conflicts and to promote wildlife conservation on private and communal lands.

Predation of livestock and domestic animals and crop damage by wildlife undermine people's willingness to conserve wildlife or to manage their land for wildlife. Wildlife damage to people's property, legal restrictions on how people may use their land because of the presence of wildlife, and fear of wildlife may lead to illegal or retaliatory killing of wildlife and the deliberate conversion of wildlife habitat to other uses to pre-emptively prevent wildlife using land. The impact of legal and illegal trade in wildlife on people and wildlife have been investigated, and how trade in wildlife can be used to attain sustainable use of wildlife and improved economic and social welfare for landowners and communities in South Africa.

The legal trade in wildlife (e.g., game farming, community-based tourism, the pet trade) generates multiple economic and social benefits that may help to motivate people to conserve wildlife. However, the full benefits and costs of



wildlife trade are not fully understood. Poaching and illegal trade in wildlife remain a threat to wildlife conservation. Both in South Africa and globally, people place value on the conservation of wildlife species. Understanding this value is important for making decisions on how to allocate resources to wildlife conservation.

Some of the projects that have been conducted include private landowners' opinions of, and willingness to engage in, legal trade in rhino horn in South Africa, the decision of farmers to protect oribi on their lands, the vulnerability of community members to predators. This theme is led by associate Prof Elizabeth (EF) Pienaar who specialises in human dimensions of wildlife conservation and environmental economics. She is based at the Department of Wildlife Ecology and Conservation at the University of Florida (US).

- Marine mammals

Marine mammals have been studied at the MRI since the 1970s, when work on Antarctic and Subantarctic seals began. This work formed the basis for the establishment of several long-term research projects that persist to this day. The formation of the Whale Unit consolidated cetacean research at the MRI in the 1980s.

This theme is co-led by associate Prof Nico (PJ) de Bruyn, Principal Investigator of the Marion Island Marine Mammal Programme (MIMMP), who joined the MRI in 2010, and Dr Els (E) Vermeulen, Research Manager of the Whale Unit (MRIWU), who joined in 2015. Together they have 16 national and 44 international long-standing collaborations that bear testament to the value of their long-term, world-class databases and high standard of research. The MIMMP research concentrates primarily on Marion and Prince Edward Islands, the Tristan da Cunha archipelago and the Antarctic ice shelf, while the MRIWU conducts research along the Western Cape coast, northern KwaZulu-Natal and into the Southern Ocean.

### **Conservation Ecology Research Unit**

The Conservation Ecology Research Unit (CERU) is a small group of scientists and technicians within the Department of Zoology and Entomology that was established in 1999 by Prof Rudi (RJ) van Aarde. It receives logistical and financial support from industry, non-governmental organisations, and contract-related projects.

CERU serves as a platform for ecological research that contributes to the conservation of species and benefits from collaboration with leading international researchers, including

Prof Stuart Pimm at Duke University and Prof Alfred (AL) Roca at the University of Illinois (US). Research activities are sanctioned by conservation agencies across Southern Africa and primarily focus on elephant ecology and restoration ecology.

From 2009 to 2018, 15 honours, 12 master's and 7 PhD students completed their degrees within the research unit and 59 papers were published in high-impact journals, including *Proceedings of the National Academy of Sciences of the United States of America* (PNAS).

CERU's aims include:

- Maintaining a logistical and financial platform for innovative conservation-related research
- Providing industries (conservation, health, agriculture, mining, and forestry) and society with the expertise and advice to maintain ecological processes as a goal of conservation ecology
- Developing science-based and humane conservation incentives to inform societal values and decision-taking processes.

## **RESEARCH CHAIRS AND CENTRES OF EXCELLENCE**

The South African Research Chairs Initiative (SARChI), established in 2006 by the Department of Science and Technology (DST) and the National Research Foundation (NRF), has had as its main objective to strengthen research capacity at universities in South Africa.<sup>8</sup> In 2018, there were 10 SARChI Chairs in the Faculty of Natural and Agricultural Sciences. Brief descriptions are given below, followed by descriptions of the three Centres of Excellence located within the Faculty.

The DST-NRF Centres of Excellence (CoE) were established two years earlier, in 2004, with UP being one of the first hosts. By 2018, there were two national and one regional CoE in the Faculty.

### **SARChI Chair in Biostatistics**

The SARChI Chair in Biostatistics was awarded to UP's Department of Statistics in 2018 to lead the development of a biostatistical research group for biostatistical methodology and applications in South Africa. The priority is to develop and disseminate novel biostatistical methodologies to solve public

health-related real-world problems as well as to educate and train next-generation biostatisticians with advanced skills to optimise the public health decision-making process. The Chair, it was anticipated, would directly address health innovations. In addition, it would actively support initiatives aimed at strengthening training in statistical methods for the analysis of infectious diseases and emerging infectious diseases.

Headed by Prof Ding-Geng (DG) Chen in the Department of Statistics, there were several achievements. Prof Chen is an NRF B2-rated scientist, and in 2018 alone, his publications and scientific presentations included five books, 21 scientific papers, two keynote addresses and 13 invited talks.

The aim of the Research Chair is to develop an internationally collaborative biostatistical research programme at UP, in partnership with the Faculty of Health Sciences, the SARChI Chair of Sustainable Malaria Control, and the SARChI Chair in Mathematical Models and Methods in Bioengineering and Biosciences. This research programme has also included partnerships with individual researchers at UP, as well as other universities in South Africa.

Collaboration in this period were with:

- The University of KwaZulu-Natal (UKZN) in the co-supervision of postgraduate students, and in research workshops and seminars.
- The South African Medical Research Council (SAMRC), the Council for Scientific and Industrial Research (CSIR) and the Human Sciences Research Council (HSRC), and faculties of Health Sciences in South Africa.
- The University of North Carolina-Chapel Hill's Department of Biostatistics in the development of novel biostatistical methodologies; and with the Arizona State University (both in the US) in the co-development of an international symposium on biostatistical modelling and application.

The focus was on developing biostatistics methodologies for designing and building research foundations for health research and interventions, and on solving interdisciplinary health problems in Africa, such as tuberculosis, malaria, HIV/AIDS, cancer, substance abuse and Ebola.

### **SARChI Chair in Carbon Technology and Materials**

The Chair in Carbon Technology and Materials was one of the first SARChI Chairs established in 2006 and was first designated as the Department of Science and Technology

<sup>8</sup> <https://www.nrf.ac.za/core-mandate-business-divisions/risa-directorates/research-chairs-and-centres-of-excellence-rcce/south-african-research-chairs-initiative/>

Pebble-bed Modular Reactor (DST/PBMR) Chair in Carbon Technology and Materials. It was awarded to the University of Pretoria and was hosted in the Institute of Applied Materials with Prof Walter (WW) Focke as Director who also acted as the line manager to the Chair holder who reported to the Dean through the Director of the Institute.

The Institute of Applied Materials is a multidisciplinary entity established as a collaboration between two faculties — Engineering, Built Environment and Information Technology (EBIT) and NAS. The Chair was established as part of the Institute because it was expected to be multidisciplinary with the participation of the departments in these two faculties. In 2007 the Chair became part of the SARChI Chair in Carbon Technology and Materials. It kept the original structure of a steering committee and the Chair holder reporting to this committee. Prof Brian (B) Rand was appointed as the first Chair holder, a position he held in a part-time capacity until 2014.

A Deputy Chair was also appointed and it was expected that ideally the incumbent would have a complementary background to the Chair holder, and take over the duties of the Chair within six years. Together they would provide coordination and leadership and mobilise other University staff and resources to complement their fields of expertise. Collectively the group would supervise research students and offer formal courses in various aspects of nuclear science and technology. Other junior positions and administrative staff would support the Chair and the Deputy Chair. It was under these circumstances that Prof Ncholu (N) Manyala first joined as Deputy Chair in 2009 and, in 2015, became the substantive Chair when Prof Brian Rand stepped down from this position.

In 2010, the PBMR was discontinued and a new carbon-based research direction had to be found. The focus shifted to carbon-based materials for energy storage application using nano-carbon materials, under the leadership of Prof Manyala, and bulk carbon-based materials, under the leadership of Prof Rand.

Between 2009 and 2018, the Chair produced 109 publications, and supervised postgraduate students of whom 53 had graduated — five honours, 22 master's and 25 PhD graduates. In addition, it established five local and ten international collaborations in research.

### **SARChI Chair in Clean and Green Energy**

Prof Mmantsae (MM) Diale in the Department of Physics, and leader of the Solar Energy Collection and Conversion Research

Group, was awarded the DST-NRF SARChI Chair in Clean and Green Energy in June 2018.

The aim of the Chair is significantly to increase the number of high quality, well-trained graduates in the energy landscape of South Africa, while also catering for students from SADC and other parts of Africa. Prof Diale, with expertise in semiconductor physics, is a strong advocate for clean renewable energy.

An inclusive economy, as advocated in South Africa's National Development Plan (NDP), is linked to the provision of energy and renewable energy resources. This would include the move to less carbon-intensive electricity production, especially in contexts where the supply of energy intersects with poverty, which necessitates the upscaling of affordable renewable energy sources to non-grid users.

Energy research linked to the Chair will follow an interdisciplinary approach, and include the disciplines of Physics, Chemistry, Engineering, Materials Science and Biology. It is anticipated that, under the auspices of the Chair, new technologies will be developed in South Africa, thereby broadening access to renewable energy sources to all communities, including those in far-flung rural areas.

Prof Diale enjoys research collaborations in Senegal, Ghana, Zambia, Tanzania and Uganda. All these connections are in solar energy materials research, including nanotechnology and semiconductor physics. She also is part of a consortium that received funding from the World Bank to work on nanotechnology research in water purification.

### **SARChI Chair in Fungal Genomics**

The SARChI Chair in Fungal Genomics was established in January 2016 to promote research and capacity building in this field. While the main focus of the research was related to fungal tree pathogens, the vision has remained to develop collaborations with researchers focused on fungal pathogens in crop plants and fungi of medical relevance.

The Chair holder, Prof Brenda (BD) Wingfield, sequenced the first fungal genome in Africa and the SARChI Chair serves to build on Prof Wingfield's expertise in the field. It seeks to develop human capacity in the field of fungal genomics, including genome sequencing, assembly and annotation. Furthermore, access to the genome sequence of important fungal pathogens would facilitate functional genetics of these species, and with time and sufficient genomes, genome-wide association studies that would allow for the identification of

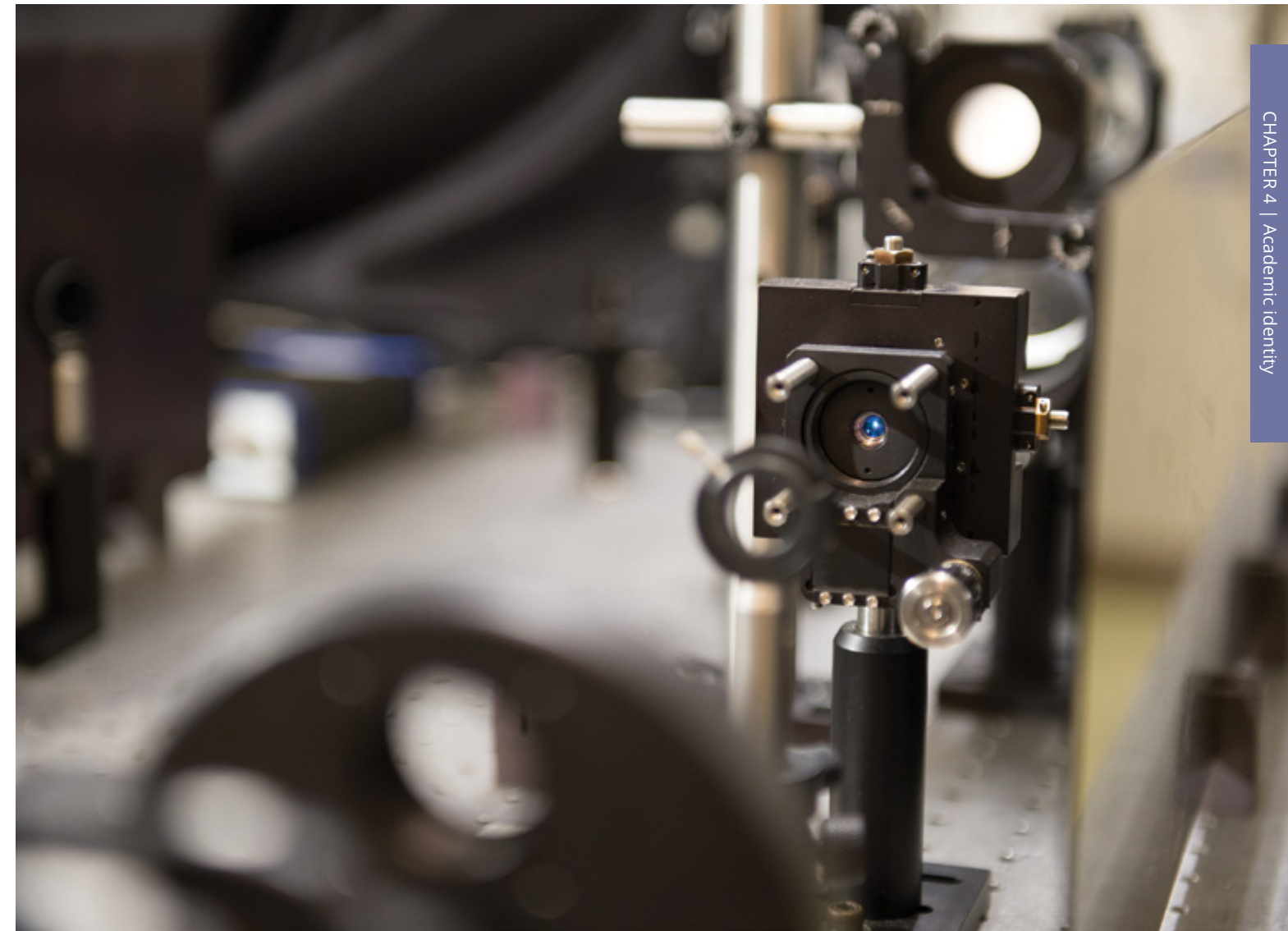

genes involved in pathogenicity. These genes would provide important targets to be used in developing management strategies for such pathogens.

The Chair is located in the Department of Biochemistry, Genetics and Microbiology and linked to the Forestry and Agricultural Biotechnology Institute (FABI).

There were several achievements and accolades:

Prof Wingfield is an NRF A-rated researcher. Eight master's and seven PhD students graduated during this period, and

43 peer-reviewed articles were published in journals such as *Fungal Genetics and Biology*, *Fungal Biology Reviews*, *Fungal Biology*, *Plant Pathology*, *Biological Invasions*, *Plant Physiology*, *New Phytologist* and *G3-Genes Genomes Genetics*.

Prof Wingfield was appointed to national and international leadership positions and she received several awards which included:

- Fellow of the African Academy of Science (AAS) (2016)
- Vice-President of the Academy of Science of South Africa (ASSAf)

- Secretary-General of the International Society of Plant Pathology (ISPP) (2013)
- Panel member for European Research Commission (ERC) LS9, Brussels and panel member on the Norwegian Centres of Excellence committee (2016)
- Recipient of the American Phytopathological Society Fellow Award (2017)
- Honorary member of the Mycological Society of America — the highest honour for an international mycologist (2017)
- First female recipient of the South African Society of Microbiology Gold Medal (2018).

### **SARChI Chair in Mammal Behavioural Ecology and Physiology**

The Chair was awarded to Prof Nigel (NC) Bennett and designed specifically to investigate aspects of mammal behavioural ecology and physiology, two disciplines that were generally under-represented in South Africa at the time of the application. The vision of the Chair was to conduct high quality research and train quality postdoctoral, doctoral and master's students in the field of small mammal biology with particular reference to physiology, ecophysiology, behavioural ecology and molecular ecology.

Prof Bennett was the sole driver of the Research Chair during the period 2009 to 2018. The SARChI Chair of Mammal Behavioural Ecology and Physiology resided in both the Department of Zoology and Entomology and the Mammal Research Institute in NAS under his leadership. During this period, the Chair and its research group published an impressive 203 peer-reviewed scientific papers.

Further accolades bestowed on Prof Bennett during this period included:

- Appointment as a member of ASSAf (2010)
- Recipient of the UP Chancellor's Medal for Research (2012 and 2018)
- Recipient of the Havenga Prize from the Academy of Sciences: Life Sciences
- Recipient of the National Science and Technology Forum (NSTF) award for research capacity development over the last 5 to 10 years (2015)
- Recipient of the UP Vice-Chancellor's award for supervision (2017)

- Acceptance as a Fellow of the African Academy of Sciences (2017).

The Chair had 42 active collaborations globally in Africa, Australasia, America, Europe and Asia. Prof Bennett set out in his Chair to be internationally competitive and to attract international students and postdoctoral fellows. During this period, he was Editor-in-Chief of the *Journal of Zoology*, London, Editor-of-Proceedings of the Royal Society of London *Biological Sciences B* and in 2013 he took on the Handling Editor position at *Biology Letters* — another Royal Society journal. During the period 2009 to 2018 Prof Bennett maintained an A rating from the National Research Foundation.

Since 2006, Prof Bennett has also held the Austin Roberts Chair of African Mammalogy.

### **SARChI Chair in Mathematical Models and Methods in Bioengineering and Biosciences**

The research focus of the Chair in Mathematical Models and Methods in Biosciences and Bioengineering (M<sup>3</sup>B<sup>2</sup>) is at the intersection of mathematical modelling of biological processes and a spectrum of mathematical specialisations. These areas of specialisations are broadly located within analysis, such as ordinary and partial differential equations, dynamical systems, multiscale analysis and computational methods.

The biological processes considered by the Chair are highly relevant to the country's needs, and include mathematical epidemiology, specifically the identification, through building mathematical models and their analysis, of adequate scientific, engineering or medical responses to both new and old diseases such as Covid-19, malaria, tuberculosis, cancer, HIV/AIDS and other communicable diseases that pose a massive threat to development in South Africa and the continent.

An essential part of the epidemiological research has been related to plant diseases and their impact on agricultural yield and, in particular, the analysis of the 'sterile insect techniques'. The Chair has also developed new mathematical and numerical methods for population dynamics, including phytoplankton dynamics and animal grouping, ecological problems related to the stability of savannahs, and other fields of interest in life and medical sciences.

Established in August 2013, it is located in the Department of Mathematics and Applied Mathematics. The first incumbent was Prof Jean (JMS) Lubuma, who resigned in 2015 to take



Prof Nigel Bennett (SARChI Chair), with students

up the position of Dean of the Faculty. During 2015 the Chair had been under the interim leadership of Dr Michael (M) Chapwanya until the current Chair, Prof Jacek (J) Banasiak, was appointed on 1 January 2016.

During the review period, the work of the Chair was supported by a team of Principal Investigators consisting of both mathematicians and biologists who included Prof Lubuma (after vacating the Chair), Prof Roumen (R) Anguelov, Dr Chapwanya, Prof Yves (Y) Dumont, Prof Armanda (ADS) Bastos, Dr Abdullahi (AA) Yusuf, Dr Salisu (SM) Garba, Dr Rachid (R) Ouifki and several others, who were changing over the years.

The Chair developed close collaboration with the Bulgarian Academy of Sciences, International Centre for Research and Decision Support (CIRAD), University of Warsaw and Technical University of Łódź (both in Poland), and locally with the African Institute of Mathematical Sciences (AIMS), the South African Centre for Epidemiological Modelling and Analysis, and the UP Institute for Sustainable Malaria Control.

The Chair organised a series of successful meetings that included three joint workshops by UP and Unisa in 2014, 2015 and 2016. It also organised the Annual International Conference on Mathematical Methods and Models in Biosciences in Skukuza, Kruger National Park in 2017, and initiated, in 2018, a series of October Workshops on Research Trends in Mathematical Modelling and Analysis in Life Sciences in Pretoria, South Africa.

The following were among the achievements and awards of the current Chair, Prof Banasiak:

- An NRF B1 rating since 2009
- Visiting professorship at the University of Strathclyde (Scotland) since 2010
- The South African Mathematical Society Award for Research Distinction (2012)
- The Cross of Merit (Silver) of the Republic of Poland (2013)
- The best paper award in applied mathematics by Centre for Applications of Mathematics (Gdańsk) (2014)

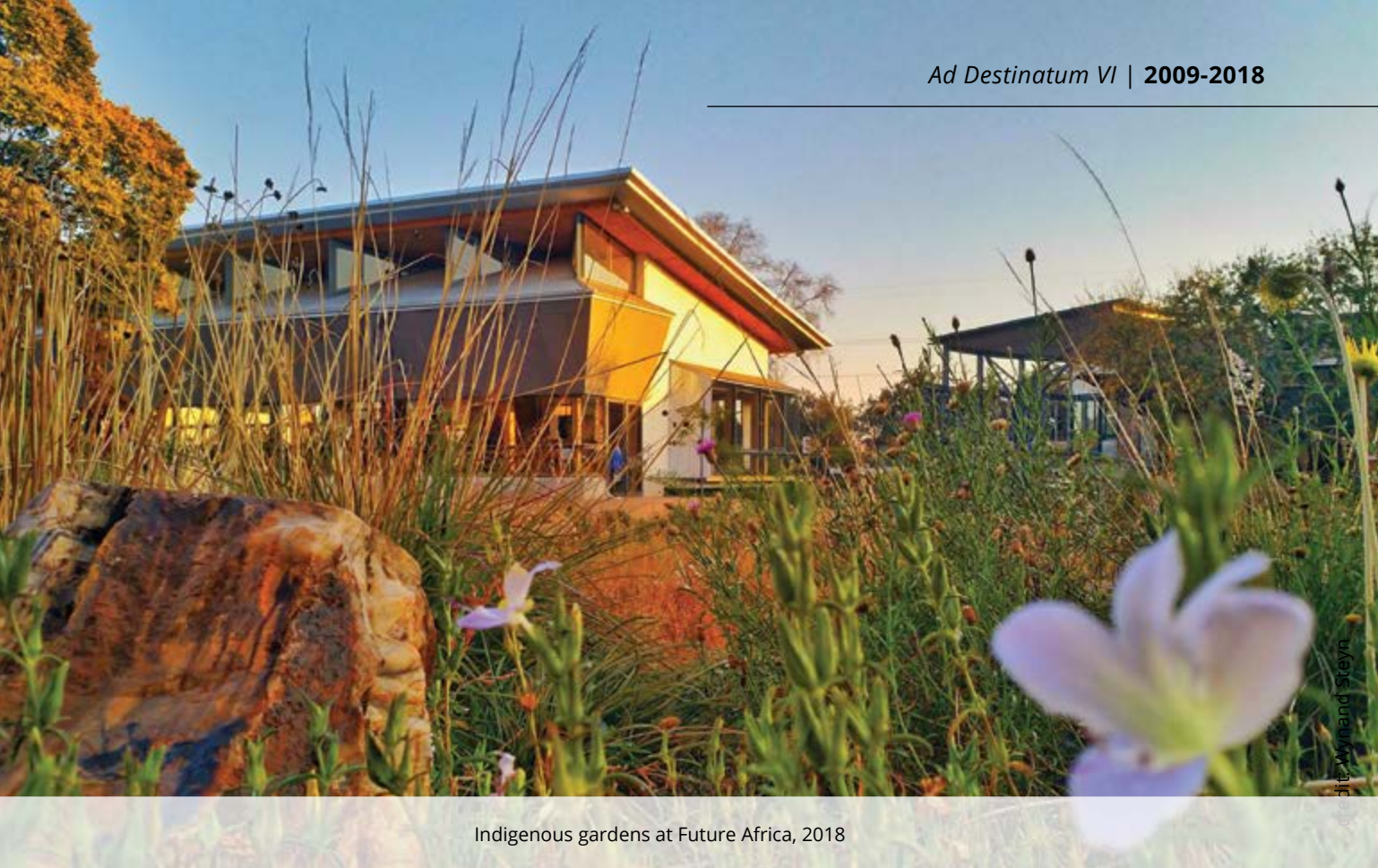

Indigenous gardens at Future Africa, 2018

- Fellowship of the African Academy of Sciences award (2017).

The Chair was (and still is) the Editor-in-Chief of *Afrika Matematika*, an official journal of the African Mathematical Union published by Springer, and a member of editorial boards of four other journals, all of which are accredited by the International Statistical Institute (ISI).

### **SARChI Chair in Nutrition and Food Security**

Prof Hettie (HC) Schönfeldt, an NRF B3-rated scientist, was awarded the DST-NRF SARChI (Tier 1) Chair in Nutrition and Food Security in July 2018. The Chair is aimed at significantly expanding the scientific research base on food and nutrition security of South Africa in a way that supports implementation of the national research and development policies translating into socio-economic benefits. It is envisaged that the Research Chair will provide a major contribution within the University to boost the visibility of research and capacity development in agriculture, nutrition and health with relevant educational applications. These research fields include the nutrient quality of food through to applied studies (e.g., the impact of policies

and regulations relating to food quality and consumer beliefs). An interdisciplinary approach will be pursued, in order to foreground nutrition in agricultural production, health and education.

In 2018 alone, eight peer-reviewed articles were published, as well as a chapter in *Advances in Food Security and Sustainability*. In all, six posters and two papers were presented at national conferences, and one paper co-authored for the 8th Africa Nutritional Epidemiology Conference.

### **SARChI Chair in Plant Health Products from Indigenous Knowledge Systems**

Prof Namrita (N) Lall holds the SARChI Chair in Plant Health Products from Indigenous Knowledge Systems at UP. First awarded in 2016, the Chair is located in the Department of Plant and Soil Sciences: Medicinal Plant Sciences Division.

The Chair aims to promote the use of traditional medicine and to investigate the potential of indigenous biological resources for the development of cosmeceutical and pharmaceutical products evaluating *in vitro* and *in vivo* efficacy and safety.

Prof Lall has received several awards and nominations in her position as SARChI Chair, and before her appointment to this position, in 2014, she received the Order of Mapungubwe — the highest honour of South Africa, from the state president. She also received, in August 2011, the DST Distinguished Young Women in Science Award. More recently, the following:

Prof Lall had published 59 articles in DHET-accredited, peer-reviewed journals and was the editor of a book published in 2018, *Underexplored Medicinal Plants from Sub-Saharan Africa* (Academic Press, Elsevier), with two more books in the pipeline. In addition to her awards and nominations, Prof Lall has 12 patent specifications with the following achievements around the commercialisation of technologies:

- Botanica Natural Products has obtained a non-exclusive licence for seven of the Research Chair's technologies including actives to treat acne, uneven skin tone, boost sun protection factor (SPF), hydration and blemishes.
- Letago Pharmaceuticals has obtained a non-exclusive licence for one of the Research Chair's technologies in a liver protectant product.

### **SARChI Chair in Sustainable Malaria Control**

The SARChI Chair in Sustainable Malaria Control was initiated in July 2013 with Prof Lyn-Marie (LM) Birkholtz as incumbent, and hosted in the Department of Biochemistry. The Chair functions within the UP Institute for Sustainable Malaria Control (UP ISMC) with Prof Tiaan (C) de Jager (Dean, Faculty of Health Sciences) as Director. The UP ISMC is a transdisciplinary, interfaculty initiative which pioneers research into innovative, safer and sustainable methods to control malaria in South Africa and Africa. Within this context, the Chair directs the parasite cluster with the aim of delivering health innovations to support malaria elimination strategies.

The core research is focused on malaria parasites transmission biology and intervention. The Chair reports to an advisory committee within the UP ISMC structure. Initially awarded as a 'Tier 2' Chair in 2013, it was upgraded to 'Tier 1' status in 2018, based on extraordinary performance and development. This achievement was recognised within UP with Prof Birkholz receiving an Exceptional Young Researcher Award, and externally, an NRF B rating.

The Chair has established expertise in parasite biology and pharmaceutical biochemistry. By 2018, the programme expanded to include five additional staff members. The Chair's transdisciplinary nature allowed annual training of, on average, 25 postgraduate students in cutting-edge

technologies in new research frontiers. In 2018, Prof Birkholtz received the UP Vice-Chancellor's Exceptional Supervisor Award, and the NSTF Science Communication Award.

Infrastructural developments supported by UP and external funding resulted in the development of a dedicated molecular parasitology facility, the largest of its kind in Africa. This facility enabled the development of a Drug Discovery for Malaria Elimination Platform and the only Global Test Centre for transmission-blocking antimalarials for the Medicines for Malaria Venture (Switzerland) within the Chair's programme.

Significant discoveries included fundamental insights into critical regulatory factors driving the developmental biology of both the asexual and gametocyte forms of malaria parasites. This spearheaded the discovery of transmission-blocking antimalarials, as evidenced by delivery of the first antimalarial drug discovered on the African continent, in collaboration with the University of Cape Town (UCT).

The Chair also directed several national initiatives, including the South African Malaria Transmission-blocking Consortium (UP, Wits and the CSIR) and an African-centred Community of Practice on Malaria Elimination Interventions (funded by the NRF) which delivers tangible outcomes and policy advisory to guide the South African Malaria Elimination Strategy. The Chair's activities are supported by additional external global partnerships and funding of R17 million annually.

### **National Zoological Gardens SARChI Research Chair: Conservation Physiology**

In early 2017 the NRF opened a call for SARChI chairs at national research facilities, each to be co-hosted by a university. Prof Andrew (AE) McKechnie, then Head of the Department of Zoology and Entomology at UP, applied for a chair linked to the National Zoological Gardens to be co-hosted by the University of Pretoria. The application was successful and the SARChI Chair in Conservation Physiology came into being in late 2017.

The mandate of the Chair is to apply physiological approaches to conservation challenges, most notably understanding the consequences of rapidly accelerating climate change for biodiversity in South Africa and globally. Prof McKechnie and his students remained physically based in the Department of Zoology and Entomology. The Chair's research programme involved expansion of work by the Hot Birds Research Project, a collaborative team from UP, UCT and several other local and overseas institutions. The first full year of funding, 2018, saw the recruitment of several team members, including PhD



student Celiwe (CA) Ngcamphalala, who subsequently went on to an academic position at UCT, and postdoctoral fellow Dr Zenon (ZJ) Czenze, currently a lecturer at the University of New England (Australia).

## CENTRES OF EXCELLENCE

### **Centre of Excellence in Tree Health Biotechnology**

First known as the DST-NRF Centre of Excellence (CoE) in Tree Health Biotechnology (CTHB), the Centre was established in 2004 at the Forestry and Agricultural Biotechnology Institute (FABI).

Its research focus was primarily on the health of both native and woody plants. In its second phase of development, from 2010 to 2018, the DST-NRF moved the CTHB to full-funding and its research focus expanded to include the health of commercially propagated tree resources. At the cusp of this review period, the Centre entered its third stage of development (2019 and beyond), with a name change to the DSI-NRF Centre of Excellence in Plant Health Biotechnology (CPHB) and a broadened research focus also to include the health of other socio-economically important plants, in addition to trees.

Prof Mike Wingfield was the founding Director of the CTHB, from 2004 to 2017. Prof Emma (E) Steenkamp took over this leadership position in 2018, following her position as programme leader (since 2009) and deputy director (since 2014). The CTHB is structured as a virtual Centre that conducts scientific research via collaborative networks, with the nodes represented by researchers at UP.

The Centre has represented one of the largest initiatives globally, focused specifically on trees, and beyond 2018, on general plant health. At UP alone, the Centre includes the activities of approximately 100 people, with around 32 team members at other universities and institutions. A large team of PhD-level specialists in tree and crop health leads the programme. The remaining members of the team include postgraduate students (including BSc honours, master's and doctoral students), and a small group of technicians and administrators.

Over the period 2010 to 2018, a total of 29 MSc and 35 PhD students were supported, either through bursaries or bursary top-ups. Graduates have included 68 MSc and 50 doctoral students, with 94% employed in various sectors of

the economy where their postgraduate science education is of value.

### **Research foci and evolution**

The initial research focus of the CTHB emerged from the activities of the long-standing Tree Protection Co-operative Programme (TPCP), funded by the South African Forestry Industry. The TPCP's research on pests and disease that threaten the long-term sustainability of plantation forestry revealed an obvious nexus between pests and pathogens affecting native woody plants and trees propagated for commercial purposes. Research showed that native pests and pathogens infect plantation trees. Thus the initial focus of CTHB focused primarily on the application of biotechnology to promote the health of trees native to South Africa.

The CTHB also showed that fungi and insects associated with native tree species cause significant damage in commercial plantation forestry, especially where the native species are related to those that are commercially propagated. The decision of DST-NRF to move the CTHB to a full-funded model was thus opportune and the CTHB moved to Stage 2 in its development (2010–2018) with an expanded research focus to include the health of commercially important tree species. The CTHB vision was to ensure long-term health and sustainability of trees in natural woody ecosystems and planted environments including plantation forestry, fruit tree industries and those of recreational importance such as trees in parks and gardens.

Prior to the establishment of the CTHB in 2004, no other programme, globally, had attempted to understand how pests and diseases might affect native woody ecosystems.

### **Partners and stakeholders**

Through the course of its existence, the CTHB developed strong partnerships with key role players in industry and government, mainly forestry and agriculture. The enormous benefit that the DST-NRF funding has brought to this university-industry-government partnership is reflected in the large numbers of students trained and whose research activities were supported.

Research continued to address some of the national challenges, particularly related to food security, sustainable use of natural resources, and economic growth. At the same time, the focus has remained on building research capacity with networks involving researchers and their postgraduate students from other universities in South Africa.



### DST-NRF Centre of Excellence in Food Security

The Centre of Excellence in Food Security (CoE-FS) was established in 2014. It is hosted by the University of the Western Cape (UWC) and co-hosted by UP. Following initial discussions between UP and UWC, it was agreed that Prof Julian (J) May, a former South African Research Chair (Tier 1), would be the Director and Prof Sheryl (SL) Hendriks, the Director of UP's Institute for Food, Nutrition and Well-being (IFNuW) the Co-Director. In May 2016, UP's Executive took the decision to diversify the leadership of its strategic initiatives in food security, and asked Prof Hendriks to step down as CoE Co-Director in order to focus on leading IFNuW. Prof Lise (L) Korsten was appointed as the dedicated leader of the CoE activities at UP.

The CoE was launched with the vision 'to become a global leader in research, capacity building, and knowledge brokerage and service provision in food security and nutrition in Africa.' The CoE operates as a virtual centre that achieves its goals by funding systematic programmes of research and postgraduate training undertaken by collaborating South African universities and research councils. It works as a multidisciplinary team of research leaders, project managers and students drawn from more than 20 universities and institutions, including the Agricultural Research Council (ARC), the South African Medical Research Council (SAMRC), the Human Sciences Research Council (HSRC) and the Academy of Science of South Africa (ASSAf). Internationally it has agreements in place with the University of Missouri (US), Institute for Development Studies (UK), University of Sussex (UK), and with CIRAD (France).

At UP the CoE is an integral and strategic part of food security and nutrition research, drawing on the network of expertise from across 35 academic departments and numerous centres and institutes. Since its launch in 2014, most of the researchers have engaged in policy and governance interactions with national and local government and have provided technical background for strategic debates and think tanks. The CoE has also been able to provide a platform for sharing research expertise with local organisations, industry, institutions of learning and others, to ensure that new knowledge is generated and that it will contribute to policy, transformation, awareness and knowledge brokerage for the public.

By 2018, the researchers and students of the CoE had established linkages with research groups working on food security and nutrition in all provinces of South Africa, including with the CoEs in Human Development at the

University of the Witwatersrand (Wits), Indigenous Knowledge Systems at the University of KwaZulu-Natal (UKZN), Nutrition at North-West University (NWU), and Scientometrics and Science, Technology and Innovation Policy at Stellenbosch University (SU).

Internationally, the CoE has linked with the South African/German Centre of Excellence in Development Research (SA-GER CDR) at UWC, with the Ghanaian-German Centre for Development Studies at the University of Ghana and the Namibian-German Centre for Logistics at Namibia University of Science and Technology. The CoE's researchers are involved in joint research projects that have been conducted or are underway in Burundi, Ethiopia, Ghana, Kenya, Mozambique, Mauritius, Sudan, Tunisia, Uganda, Zambia and Zimbabwe.

Further afield, the directors and principal investigators (PIs) have engaged with researchers working in food security in Europe (Austria, Belgium, Czech Republic, Finland, France, Germany, Italy, Netherlands, Norway, Sweden and the UK), the USA, Canada, Australia, Brazil, Mexico, Hong Kong and China.

By the end of April 2018, 83 projects and work packages had been funded from a variety of sources and the CoE's researchers and students had published a total of 142 research outputs. The CoE supported 143 students' and 15 postdoctoral fellows' registrations, and had 41 graduates from 2014 to 2018. On average, the CoE-FS has provided funds to 16 project leaders each year since inception. The publication output per project leader is in the order of 3,18 units per annum.

Using Google Scholar to accommodate the multidisciplinary nature of the field of study, the H-index of the CoE-FS stands at 30 (30 papers that have been cited at least 30 times). Recognition of the different ways in which the CoE-FS has contributed towards the knowledge base of food and nutrition security is its inclusion in the University of Pennsylvania's 'Global Go To Think Tank Index' which ranked the CoE-FS in the top 100 global think tanks in this field of work.

### ARUA Centre of Excellence in Food Security

In 2018, the African Research Universities Alliance (ARUA) CoE in Food Security (ACoE) was awarded to the University of Pretoria in collaboration with the University of Nairobi (Kenya) and the University of Ghana, Legon under the directorship of Prof Hettie (HC) Schönfeldt. The ARUA CoE in Food Security brings together ARUA members from East, West and Southern Africa, and two historically disadvantaged South African



universities as associate members (i.e., the Universities of the Western Cape and Fort Hare), as well as a broader consortium of African and international partners working on food security research, policy and capacity development to exponentially increase the networks of each participating institution, and to maximise the translation of knowledge into impact at the grassroots and/or policy levels.

The ARUA CoE undertakes research, capacity building, and knowledge transfer to drive agricultural and food system transformation to ensure sustainable food security and

nutrition in Africa — especially for poor, vulnerable, and marginal populations. The CoE focuses on partnerships and collaborations, in and beyond academia, to amplify effect.

The focus areas were selected based on the intersection between the scientific strengths of partner institutions and collaborators, the potential to undertake research projects based on 21st century science platforms and, projects addressing weaknesses in Africa's agricultural and food systems.



## 8 | Theology and Religion

### DEANS' OVERVIEW

The period under review corresponds broadly with the tenure of Prof Johan (J) Buitendag who served as Dean of the Faculty of Theology and Religion from 2010 to 2018, and who succeeded Prof Cas (CJA) Vos. Prof Buitendag started his term with an extensive process of strategic planning in the Faculty, which got the vernacular designation of 'lekgotla' and is still in use in the Faculty. The strategic plan for the relevant decade of the Faculty was, in total, the product of the first two *lekgotlas* which involved all academic staff of the Faculty. The first was held for three days, from 27 to 29 April 2010, and the second took place on 11 and 12 April 2011. All decisions were taken by means of accord, the result being that the vision and mission of the Faculty represented the shared opinion and ownership of all the colleagues. This strategy was maintained unchanged during the whole term of office of Prof Buitendag and was only changed with the appointment of a new dean, Prof Jerry (J) Pillay, who assumed office on 1 March 2018.

It was a *sine qua non* that the strategy of the Faculty would be embedded in the broader vision and mission envisaged by the University of Pretoria. Although the University had been very well on track in developing its own long-term strategic plan, UP 2025, this had not been finalised in the early years of the relevant period. The Faculty took seriously, the four strategic foci of the time, as spelt out by the Vice-Chancellor, Prof De la Rey, at the commencement of the 2010 academic year. Subsequently, the aspects of academic excellence, inclusivity, diversity and sustainability formed, to a large degree, the backbone of the Faculty's own vision and mission.

The Faculty proudly presented the following vision and mission throughout this time, complemented and buoyed by shared values, shaped by the beliefs of its academic staff:

- *Vision* | To be a faculty recognised for its creative engagement with life-giving theology and religious insight, of service to academia, church and community.
- *Mission* | To achieve this, we commit ourselves to —
  - Providing relevant theological and religious education
  - Nurturing transformative leaders
  - Quality research
  - Promoting justice, peace, the integrity of creation and reconciling diversity
  - Engaging people on the margins of society.

In pursuing the vision through this mission, the following critical success factors (CSFs) were identified, with their respective strategic gaps in terms of ideal and reality, and objectives set to address the gaps:

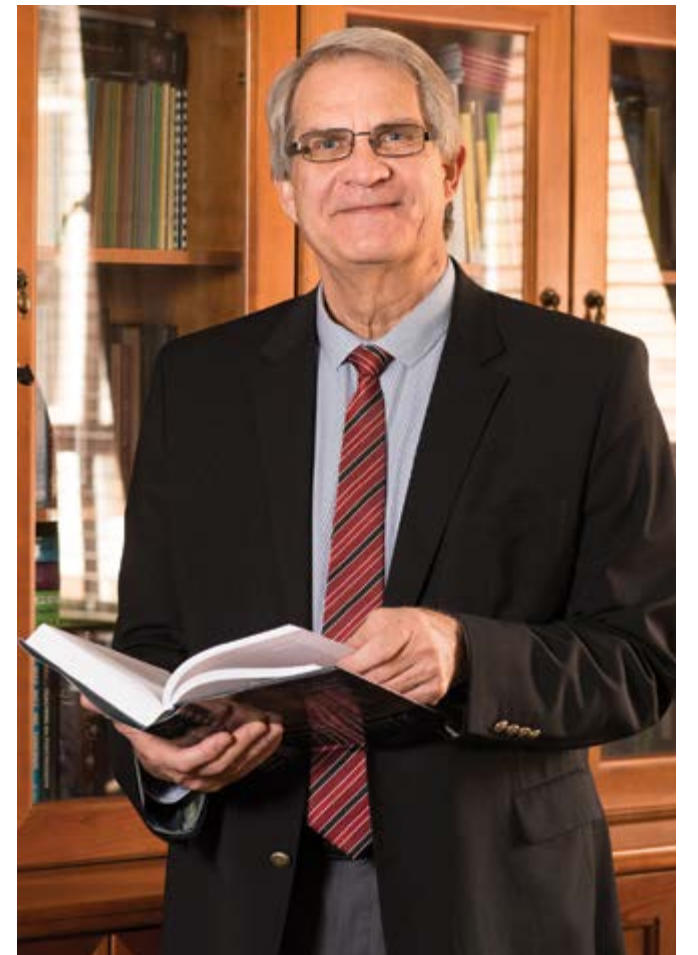

Prof Johan Buitendag | Dean, 2010-2018



l to r: Profs Jerry Pillay, Nelus Niemandt, Danie Veldsman, Johan Buitendag, Cas Wepener, Dirk Human and Gert Steyn

- Aligning the composition of the Faculty with the vision of the University and our values
- Establishing broad-based partnerships and alliances that create a sense of cooperation and co-ownership which is conducive to sharing life-giving theology
- Ensuring an integrated student body
- Pursuing environmental engagement, and
- Focusing on overall faculty management.

The first two *lekgotlas* focused on the question 'what' and subsequent *lekgotlas* on 'how'. There was no need to reinvent the wheel every year, and after the question had been answered regarding what the 'right things' were to do, the Faculty then endeavoured 'to do these things right'. The respective Faculty Plans indicated the improvements that took place over the relevant decade and the strategic gap between ideal and real that was diminishing.

Without doubt, the Centenary of the Faculty, celebrated in 2017, was the pinnacle of the review period. Even in the first century of its existence, its message was clear and distinct: the

Faculty wanted to open the gates to inclusivity and to discard all measures of exclusivity of the past. The centenary emblem indicates this in a very strong way.

### Faculty performance in overview

The highest number of **subsidised article units** (291) in the history of the Faculty of Theology and Religion was published in 2017. Similarly, the increase in the publication of books, chapters in books and conference proceedings contributed to the high impact bibliometrics for the relevant decade.

A triple helix that constitutes the nature and character of the Faculty, namely its academic excellence (world ranking), its inclusivity (open gates) and its ecclesial and societal engagement (stakeholders), was cherished dearly. Although the Faculty of Theology and Religion is the smallest faculty at UP (1.4% of students and 1.5% of lecturers), it still delivered more than 12% of the University's research article output.

The Faculty welcomed the Quacquarelli Symonds (QS) Index release in March 2017, that included the new subject area of 'Theology, Divinity and Religious Studies'. Theology at the

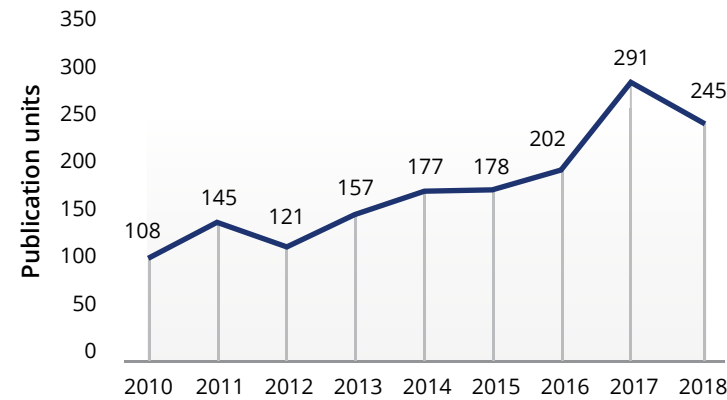

Figure 4.1. Research output over the past decade (2010–2019)

University of Pretoria was ranked 51–100 globally, and in position 28 in the world with respect to citations per paper, and position 14 with respect to H-Index citations. This placed UP first in Africa and significantly higher than many renowned institutions in Europe, the United Kingdom and the United States.

The Faculty contributed to the two church-supported scholarly journals, *HTS Theological Studies* and *Verbum et Ecclesia*. The output of these two journals represents almost two thirds of the total output of all South African theological journals. They are by far the publications of choice for theologians in South Africa and in many overseas countries. It was therefore evident, that the bulk of the Faculty's publications appeared in these two journals which also continued to receive great international recognition.

During the Centenary year, 18 (or 60%) Faculty staff were NRF-rated, and 20 by the end of 2018, which included one A-rated and three B-rated scholars. The Faculty was also privileged to have 96% of its academic staff with doctoral degrees.

The Faculty of Theology at the University of Pretoria has enjoyed recognition as the strongest Faculty of Theology in South Africa, both quantitatively and qualitatively. The fact that it developed as a faculty with full and equal academic status at UP since its inception, and not from a seminary, means that today it is the oldest fully-fledged Faculty of Theology in South Africa.

The Faculty has engaged in inter- and transdisciplinary research on social cohesion, with a focus on the problem of poverty, the challenge of reconciliation, and the need for restorative justice, involving key role-players in different sectors of society, industry and academia.

The Chancellor's Medal was bestowed on three eminent figures of the ecclesial society in South Africa during the past decade, who have contributed to addressing the abovementioned challenges:

- Archbishop Thabo (TC) Makgoba (2015)
- Ds Frederick (F) Swanepoel (2015)
- Dr Pieter Gerhard Jacobus (PGJ) Meiring (2017).

### Research themes embodied in strategic actions

The Faculty was searching for an overarching research theme to combine its strengths and the challenges of research endeavours that often are inter- and transdisciplinary as well as trans- and multi-religious in nature. The theme decided on was *Ecodomy*, an umbrella term for well-being or the fullness (literally 'to build or edify the house') of life. The meaning also entails endeavours to unearth both the brokenness and wholeness (healing) of all aspects of creation, spheres of life, church and society, relationships, and more.

The (positive and negative) role of religion and theology was identified, assessed, and re-contemplated for new themes, contexts and situations, especially for Africa and South Africa. The theme was extended in recent years to include the United Nation's Strategic Development Goals (SDGs).

An international congress was hosted by the Dean, Prof Buitendag, in September 2014 on the topic of *Ecodomy*. Two books and numerous articles resulted from this.<sup>1</sup> Themes that had been addressed were the following:

- *Book 1.* Anger in the South African society, nature and culture, love, animal consciousness, community life, wealth, poverty and mutual care, role of water, ecology, insiders and outsiders, liberation and black theology.
- *Book 2.* Apartheid and xenophobia, foreignness and exclusivism, leadership crisis, violence and war, Ubuntu, a life of faith and wisdom, reconciliatory leadership, and transforming space and community.

The greening of the building of the Faculty provided an opportunity to attend to the ecological footprint of the Faculty, and to engage students in a process of practice learning regarding the way that technical, financial, social and theological factors have to be integrated in order to promote a greener lifestyle. Much research and engagement were undertaken, by students as well as international scholars on caring for the environment. This was strongly championed by Dr Attie (A) van Niekerk and his Nova Institute.

<sup>1</sup> See *Verbum et Ecclesia*. 2015 36 (3). ([www.ve.org.za](http://www.ve.org.za))

<sup>2</sup> 'Gateway to...!', the strapline of the Centenary. The old wooden gates were initially erected as the gate from Lynnwood Road and had been in storage since the 1970s.



Centenary plaque unveiling and reinstatement of gates

Another factor that contributed to the inclusive and embracing character of the Faculty was the centenary celebrations with the central theme based on the metaphor of a 'gateway to...'.<sup>2</sup> This generated a great sense of anticipation for change, transformation, inclusive participation and engagement, all aspects which are still so desperately needed in South Africa and the world at large today.

It was important that the formal structural aspects corresponded with the material aspects (or content) of this seminal approach. The Faculty changed its MDiv degree to a one-year degree on National Qualifications Framework (NQF) Level 9 in order to give students access to a doctoral degree and introduced a postgraduate diploma on NQF Level 8 to be followed after the four-year BDiv or the BTh (Hons). The Faculty discarded the previous BA (Theology) since there was confusion at the Faculty of Humanities about this degree and its particular focus. The three-year Diploma in Theology was maintained and has become increasingly popular among new entrants.

### **Departments, research entities and programmes**

The Faculty used to have a multi-religious, multi-disciplinary and an interdisciplinary programme of *Biblical and Religious Studies*. Apart from increasing the students' levels of knowledge about the different world religions, the

programme was intended to create an ethos of inter-religious dialogue, tolerance and mutual respect. On a postgraduate level, it involved studies without the prerequisites of Hebrew and Greek. Themes on religions such as African Traditional Religions, Islam and Buddhism received stronger focus. Prof Jaco (J) Beyers was the Manager of this programme.

The Department of *Church History and Church Polity* presented the first South African Congress on Augustine of Hippo and the Manichaean Christianity in 2012, overseen by Prof Johannes (J) van Oort, an A-rated scholar in the Faculty. This resulted in a series of scholarly articles published in scientific journals, and also a book published by Brill Academic Publishing. Prof Graham (GA) Duncan, the Head of the Department, had been working in the area of Protestant responses to the Second Vatican Council fifty years on and has drawn parallels between the increasing conservatism of the Roman Catholic hierarchy, the persecution of academic theologians and the decline in ecumenical commitment. After his retirement, he was succeeded by Prof Jerry Pillay as Head of the Department who has brought an extensive ecumenical scope to the Department and later also to the Faculty. Prior to the joining of the Uniting Presbyterian Church (UPCSA), the Department had focused primarily on Afrikaans Church History, and was heavily criticised for this narrowness in an international review in 2010.

Research in *New Testament Studies* focused particularly on the analysis, description and relevance of Judaeo-Christian

identities. The foundation for this Department's research during the relevant decade was laid by Prof Gert (GJ) Steyn, a B-rated scholar, who unfortunately left the University in 2017. The research conducted was on the nexus of Hellenistic Judaism and Early Christianity, as situated within the broader contexts of late antiquity. The research themes were Jewish scriptures used by early Christian societies; social-scientific studies of the New Testament; identity formation and social transformation in early Christianity and Biblical hermeneutics in the context of African societies. The renowned New Testament scholar, Prof John (JS) Kloppenborg of the University of Toronto (Canada), received an honorary doctorate from the University in 2018 as motivated by the Acting Head, Prof Ernest (E) van Eck.

*Old Testament Studies* comprises a broad field of disciplines and sub-disciplines. It has entailed the translation, analysis, description and interpretation of the Hebrew *Scriptures* and relevant *Umwelt* documents. Prof Piet (PM) Venter retired and Prof Dirk (DJ) Human became the new Head of the Department in 2013. Three international seminars on the Pentateuch, Psalms and Prophets were organised annually, while special lectures were recurrently presented by international scholars. A former Head of the Department, Prof Andries (APB) Breytenbach (emeritus) was pivotal in the translation of the isiNdebele Bible, which appeared in 2012 and for which he received, with Pieter (P) van Drimmelen, a medal from the South African Academy for Science and Arts in 2013. An honorary doctorate was bestowed upon Prof Wim

(WAM) Beuken of Leuven, Belgium (2016), as proposed by the Department.

The initial Head of the *Department of Practical Theology*, Prof Yolanda (Y) Dreyer, held her inaugural address in 2012 with a paper entitled 'Transvaluation of values in Practical Theology — a circular movement'. After the completion of her first term as Head of Department, she was succeeded by Prof Cas (CJ) Wepener who took up an academic position at a different university in 2019. Worth mentioning, is that Prof Julian (JC) Müller presented the eighth lecture in the UP Expert Lecture Series on 5 September 2012, entitled '(Practical) Theology: A story of doubt and imagination'. This was quite an achievement for the Faculty as the Series was under the direct auspices of the Vice-Chancellor, Prof De la Rey. An active collaboration existed between the Department and several international scholars, like Prof Marcel (M) Barnard, well-known liturgy scholar from the Protestant University (the Netherlands), and Dr Abamfo (AO) Atiemo of the University of Ghana. Prof Leonora (LT) Tisdale of Yale University (US) presented a seminar with the Worship in Africa Research Group (WARG). Monographs were published by Profs Maake (MJS) Masango, Johann-Albrecht (JA) Meylahn and Dreyer of the Department. An honorary doctorate was bestowed upon Prof Emmanuel (EY) Lartey of Yale Divinity School (2018).

The *Department of Science of Religion and Missiology* had, for the major part of the past decade, Prof Nelus (CJP) Niemandt as its Head. The Department hosted the Second

Interreligious Forum conference, entitled 'Religion and Ecology'. It also hosted several conferences in association with Radboud University in Nijmegen. Two members of the Department, Prof Niemandt and Prof Selaelo (ST) Kgatla, attended the 13th International Association for Mission Studies (IAMS) conference in Toronto and presented papers on the theme, 'Migration, Religion and Identity: Missiological Theoretical Issues'. The Department nominated Prof Theo (THO) Sundermeier (Heidelberg University, Germany) for an honorary doctorate in 2016.

The *Department of Dogmatics and Christian Ethics* had a productive decade of research. Prof Daniël (DP) Veldsman was Head of Department from 2011 and succeeded Prof Buitendag (2008–2010). The Department distinguished itself in interdisciplinary research, spearheaded by Profs Buitendag and Veldsman. Dr Vuyani (VS) Vellem received acknowledgement and accolades for his publications on Black Theology. With the support of New Partnership for Africa's Development (NEPAD) and the United Nations Development Programme (UNDP), Dr Willem (W) Fourie paid visits to several African countries and the African Union as part of a project on leadership in Africa. A special occasion for the Department was the honorary doctorate that was awarded to Prof Klaus (KB) Nürnberger, a South African Lutheran theologian. This was perhaps further evidence of the ecumenical outreach of the Faculty after the honorary doctorate to Archbishop Desmond Tutu in 2002. The world-renowned scholar, Prof Jürgen (JD) Moltmann, received an honorary doctorate from the University during the Faculty's centennial in 2017. This conferral was seen as the apex of the centenary celebrations and received international recognition.

Research foci included the following:

- The *Institute for Missiological and Ecumenical Research* (IMER/ISWEN) was strongly focused on the projects of Dr Attie (A) van Niekerk, such as the People's Power Project, with themes like 'Health care' and 'Energy use in townships'. Important to note was the collaboration with the so-called NOVA-project which was funded with third-stream income and was highly successful.
- The *Centre for Contextual Ministry* (CCM) mainly focused on undergraduate education for pastors in rural areas and contextual short programmes. The research of this Centre was strongly embedded in the Department of Practical Theology. When Prof Malan (M) Nel left in 2014, he was succeeded by Dr Stephan (S) de Beer.
- The central focus of the *Centre for Public Theology* (CPT) was on the research of its then Director, Prof Etienne

(DE) de Villiers and the emphasis on the public role of churches in democratic South Africa. Its research was strongly embedded in the Department of Dogmatics and Christian Ethics. Prof Vellem became the Director after the retirement of Prof De Villiers in 2011.

These three entities were fused in 2019 into the *Centre for Religion and Society*, in line with the new structure of the Faculty.

- Research in the Reformed Theological College was focused on denominational strengths and needs of the Netherdutch Reformed Church of Africa (NHCA), one of the ecclesiastical partners of the Faculty. The College involved researchers from this denomination as research associates of the Faculty. Their output averaged between three to five articles per annum.

In addition to the research undertaken by the respective departments and centres, the Faculty of Theology had embarked on a functional approach by clustering the Faculty into four main research fields, namely:

- *Basics* (Old Testament Studies and New Testament Studies)
- *Beliefs* (Dogmatics and Christian Ethics, Church History and Church Polity)
- *Practices* (Practical Theology, Science of Religion and Missiology), and
- *Religion Studies*.

The hallmark of the profile and character of the Faculty of Theology in this review period could be described as working towards transformation through achieving greater diversity and inclusivity. Partnership and the development of ecumenical links were at the forefront of most faculty endeavours. As a multi-religious, multi- and interdisciplinary centre of excellence, the aim was to foster an ethos of inter-religious dialogue, tolerance and mutual respect in the University of Pretoria and in society, in general.

Two new agreements had been reached and were approved by the University's Executive and Senate. These agreements, signed on 8 June 2011, were:

- The Uniting Reformed Church of South Africa (URCSA) agreement brought the official church partners to four, together with the Uniting Presbyterian Church in Southern Africa (UPCSA), Dutch Reformed Church (DRC) and Netherdutch Reformed Church (NDRC).



Prof Jürgen (JD) Moltmann, recipient of an honorary doctorate at the Faculty's centennial graduation ceremony in 2017

- The agreement with the Cape Town Baptist Seminary (CTBS) was terminated in 2017.

The intention to foster inclusivity and new partnerships meant that the Faculty continually had to broaden its undergraduate base. This is the area where the Faculty changed most significantly in terms of diversity. In 2010, black students constituted only 20% of the undergraduate student body. These numbers increased to 64% in 2018.

Although the numbers of traditional partners were diminishing, the non-partner cohort was steadily expanding.

A Transformation Committee was established in the Faculty after the #FeesMustFall campaign of 2015/2016, which was representative of all stakeholders. The concurrence of staff and students in this regard, was regarded as a *sine qua non*. The confirmed agenda for transformation comprised the following:

- Creating a common understanding of the UP 2025 vision and the Journey for Change imperative
- Sharing perceptions of barriers and enablers to diversity at UP
- Understanding the benefits of lived diversity (academic and social)
- Creating a climate of improved race relations and understanding the negative impact of prejudice.

The golden thread of the desired outcomes for this period was — according to the Faculty of Theology and Religion — to deliver to society and academia a cohort of well-rounded students, developed and nurtured by a just and excellent university. Student-centeredness is what it was all about for this pivoting strategy.



### Structural changes

The following changes to the structure of the Faculty were approved in 2016 by Senate (Rt 268/16 and Rt 272/16):

- The Department of Church History and Church Polity and the Department of Dogmatics and Christian Ethics merged.
- The Department of Science of Religion and Missiology was converted to a Department of Religion Studies.
- The current three centres in the Faculty (Contextual Ministries, Public Theology and Sustainable Communities) was to merge into one Centre for Religion and Society.
- The name of the Faculty was to change to the Faculty of Theology and Religion.
- The five departments were renamed as follows:
  - Department of Old Testament and Hebrew Scriptures (OTL)
  - Department of New Testament and Related Literature (NTL)

- Department of Systematic and Historical Theology (SHT)
- Department of Practical Theology and Missiology Studies (PTMS)
- Department of Religion Studies (DRS).

In line with the University's graduate attributes, the 'signature' of the Faculty was the following:

- To provide relevant theological and religious education
- To undertake quality research
- To promote justice, peace, the integrity of creation and a reconciling diversity.

### New leadership

Prof Buitendag's term as Dean ended in February 2018 and Prof Jerry (J) Pillay took over as Dean on 1 March 2018. Prof Pillay undertook a process of reviewing the vision and mission of the Faculty with staff and church partners and other stakeholders participating in the exercise.

Consequently, a new direction for the Faculty was established with the following vision and mission statement:

Our vision is to facilitate life-affirming theologies by seeking to —

- Teach theologies that are constructive, critical, relevant, contextual and engaging
- Undertake quality, collaborative, inter- and transdisciplinary research
- Nurture transformative leaders that serve the academy, faith-communities and society
- Promote justice, peace, the integrity of creation, reconciling diversity and flourishing of all life
- Create a space for pluriversality, differing epistemologies, inter-religious dialogue and new technologies
- Engage critical reading of texts from religious, historical, and life experiences.

The Faculty believes strongly that theology cannot be done from 'ivory towers' but with constant and consistent

engagement with the realities of life and people. Academic endeavours should work towards impacting and transforming society to shape and develop a better life for all. This is in line with UP's goals of academic relevance, diversity and inclusivity.

Some of the major highlights of the Faculty during 2018 were the total output of 62 master's and 35 doctoral degrees conferred in that year, which was the highest number of PhD degrees the Faculty had ever produced in one academic year. Added to this was the high acclaim of the Faculty achieving a target of all academic staff having doctoral degrees.

The information presented here covers the period from 2009 to 2018. Much has transpired since then to align the Departments and Faculty to the goals and direction of the University of Pretoria and to address the growing challenges in South Africa, Africa and the world at large.

**Prof Johan Buitendag** | Dean, 2010-2018

**Prof Jerry Pillay** | Dean, 2018 and beyond



# THEOLOGY AND RELIGION: PERFORMANCE AT A GLANCE

## Enrolment and success

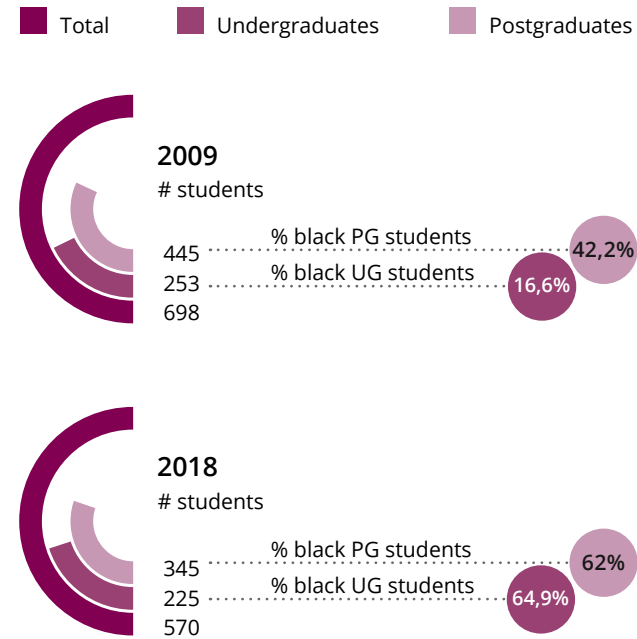

### Undergraduate module pass %

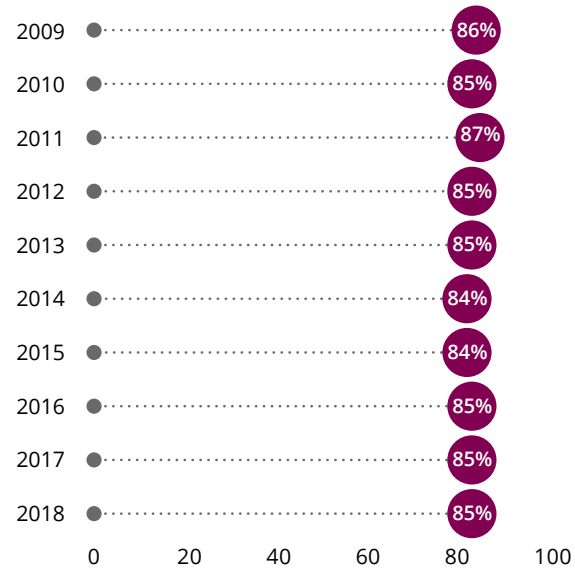

## UG graduates

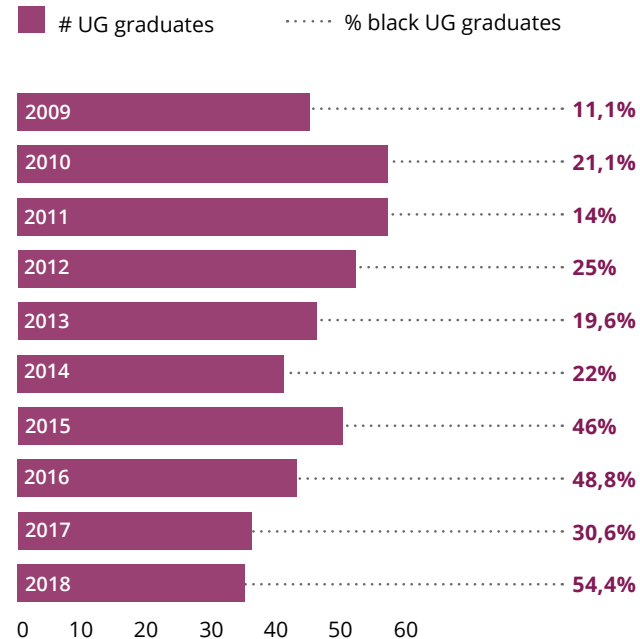

### Student : staff ratio

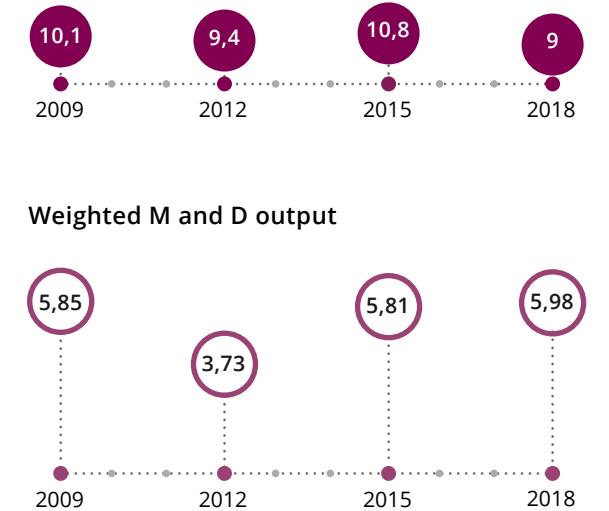

### Weighted M and D output

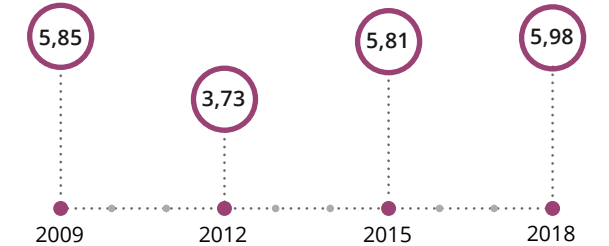

## Research pipeline

### M and D enrolment

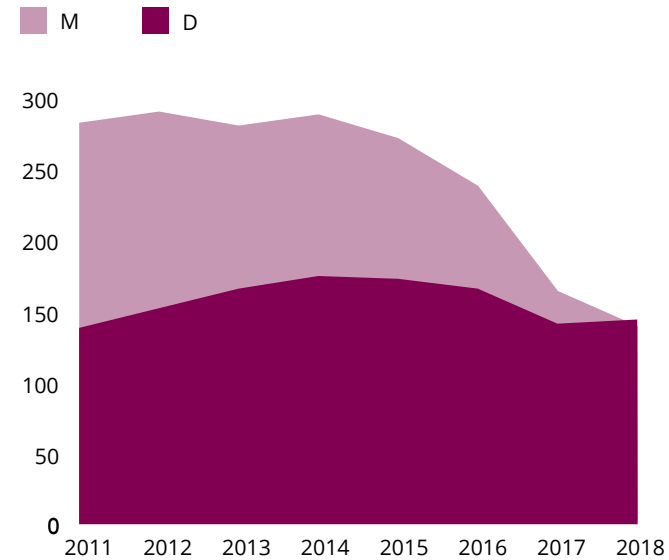

### M and D graduates

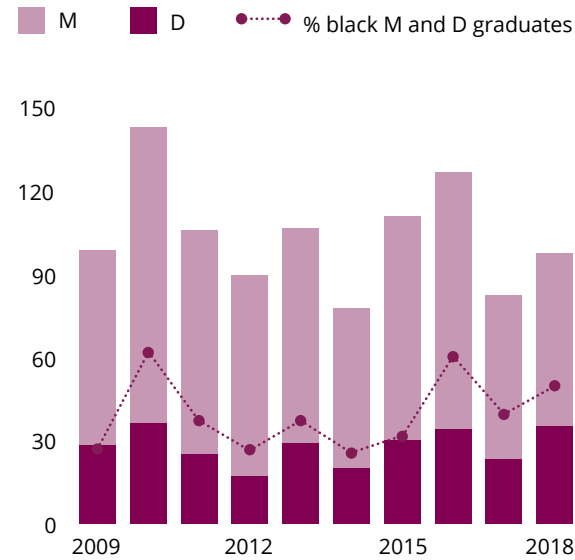

## Capacity and productivity

### % Academic staff with PhDs

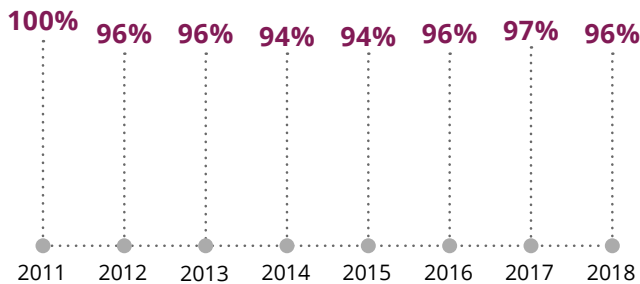

### NRF-rated researchers, 2018



### Research output

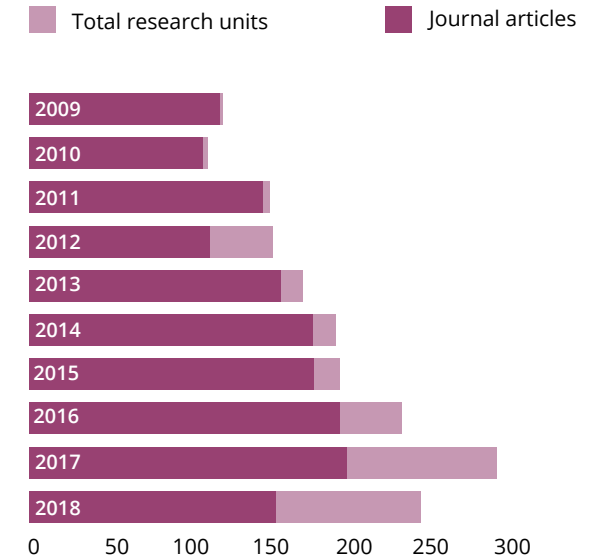



## DEPARTMENTS

## 1. Church History and Church Polity

The Department of Church History and Church Polity underwent several staff changes between 2009 and 2018. The initial academic staff members in 2009 were Prof Graham (GA) Duncan, Dr Johan (JM) van der Merwe, and Dr Kobus (JP) Labuschagne who served in a part-time capacity. Prof Duncan retired in 2014. His retirement was, in the words of the then Dean, Prof Johan (J) Buitendag, “a huge loss for the Faculty because he was not only an excellent academic and a superb teacher [...] he was an immense contributor to the *esprit de corps* of the Faculty.” After the retirement of Dr Labuschagne in 2013, Dr Wim (WA) Dreyer joined the Department in 2014. Both Drs Van der Merwe and Dreyer have since been promoted to associate professors. Prof Jerry (J) Pillay also joined the Department in 2014 and became Head of the Department in 2015, a position he held until his appointment as Dean of the Faculty of Theology and Religion in 2018.

In his inaugural address, Prof Pillay guided the Department with an important understanding of history as “essential to learn about the past, understand the present and shape the future”. He further said “that church history is a part of general history and that, more significantly, it reflects what God has done and is doing in the world”. He concluded his address by saying that what matters in the final analysis is not “a history of theology, but a theology of history”. He emphasised that it was all about how we address the “God question” to the whole of life which is important for a public university as well, since the whole world is the “Sphere Divine”.

These important remarks from Prof Pillay confirmed that the vision of the Department entailed more than the history of the Church but included the history of theology. This point of departure opened new possibilities for collaboration with other departments in the Faculty of Theology, especially the Department of Systematic Theology and Ethics. It soon became clear that the merging of the two departments made good sense. After much consultation and planning during 2017 and 2018, the outcome of the process was the establishment of a new Department for Systematic and Historical Theology in 2019.

Before the merging of the departments, the Department of Church History and Polity was one of six departments in the

Faculty of Theology, together with the Unit for Biblical and Religious Studies. Teaching in the Department was divided between Church History and Church Polity. At undergraduate level, the preponderance of time was allocated to Church History with an introductory module on Church Polity. The Department endeavoured to cover the major periods and themes in the history of Christianity with specific attention to Southern Africa and Historiography. At postgraduate level, no distinction was made, and students enrolled according to their fields of interest. Specific research areas of staff members were Augustine of Hippo, 20th Century South African Church History, African Christianity, the History of Presbyterianism in South Africa, History of Theological Education, 20th Century Ecclesiology, John Calvin and the Ecumenical movement.

With the above in mind, the mission of the Department was defined as follows: to offer relevant quality tuition at both under- and postgraduate levels which meet national and international standards; to establish a relevant research culture which is recognised nationally and internationally and in which students and lecturers reach their full potential; to accept its social responsibility towards students, clerical partners and the broader South African society; and to be recognised as an important scholarly role-player in South Africa. Several critical success factors were identified as part of the strategic plan of the Department. These were community engagement, the recruitment of postgraduate students, effective lecturers, innovative research and quality tuition.

The Department contributed to important milestones and celebrations during the past decade. Staff members took part in the international Calvin 500 celebration in Geneva in 2009. During 2017 members of the Department played a leading role in the centenary celebration of the Faculty of Theology, and in the 500th year celebration of the Reformation. In 2015 the Department, together with the Hungarian Embassy in South Africa, hosted the 600th Anniversary of John Huss's burning at the stake.

Papers by staff were delivered at several international congresses. One of the highlights in the history of the Department was the meeting between Prof Pillay in his capacity as President of the World Communion of Reformed Churches and Pope Francis on 10 June 2016 where global issues like poverty, religious violence, injustices and environmental issues were discussed. High profile meetings like these not only gave the Department a unique footprint in the Faculty of Theology as well as in the University of Pretoria, but were also to the advantage of all the students in the Department.

“To learn about the past, understand the present and shape the future” will stay the ultimate goal of the staff members of the Department.

## 2. Dogmatics and Christian Ethics

The Department of Dogmatics and Christian Ethics as an academic systematic-ethical voice at a public university in a post-apartheid South Africa can best be described from its departmental vision as follows:

It is to find and establish life-affirming theologies in a multi-church environment through the values of critical thinking, intellectual excellence, transformational praxis and inclusivity.

It is also to be consciously aware of

- ‘Where we are speaking from’, or our positioned practices (following on Ricoeur), namely as white and black, male and female Reformed theologians within South Africa, and
- Specifically, ‘How, why and where we are speaking to’, namely to the contexts and actual issues of our concrete existence.

The vision further entails that the curricula and research foci of the staff members represent the academic voice as a collection of pluriversal voices within a society strongly challenged by shifting social-ecclesial and theological landscapes. In finding and establishing its academic voice, the Department acknowledges the historical-social character of all of our understandings of our life worlds.

For the period 2009 to 2018, this covered programmes for teaching and research within the fields of doctrinal theology, systematic reflection, and Christian Ethics.

In 2009 Prof Etienne (DE) de Villiers was appointed as the Head of Department, and successor to Prof Johan (J) Buitendag. In his teaching and research, Prof De Villiers pursued the unique character and specific contribution of a Christian morality, focusing on an ethics of responsibility. For him, the most fundamental question was to find and to speak to the interaction between Christian and functional values so that justice can be done to both. The founding of a Centre for Public Theology housed within the Department was a significant practical-institutional outcome of his societal engagement from the viewpoint of the ethics of responsibility. In turn, Prof Buitendag's teaching and research spoke from and to an understanding of reality as an attempt to be a responsible discourse partner in the search for meaning and

understanding. This especially found expression in his pursuit of eco-hermeneutics in dialogue with the other sciences.

The teaching and research focus of Prof Danie (DP) Veldsman, appointed as Head of the Department in 2011, was the reconceptualisation of religious experience from evolutionary perspectives within a science-theology dialogue. His work entailed reflection on faith relationships with God from the material existence of people as historical-contextual beings who are biologically woven together.

Prof Willem (W) Fourie joined the Department in 2011. His teaching and research focused on the possibility and contours of an ethic of sociality that is useful in postcolonial, pluralist and unequal societies, specifically in the southern African context. For him, the ongoing efforts by both academics and students to ‘Africanise’, especially the human sciences, in many ways resonated with key themes in the Reformed tradition. In 2017 he was appointed at the University's Albert Luthuli Centre for Responsible Leadership.

In 2010, the late Prof Vuyani (VS) Vellem (2010-2018) from the Uniting Presbyterian Church was appointed within the Department, acting at the same time as Director of the Centre for Public Theology. In his teaching and research, he focused on Liberation Theology, especially Black Theology and themes such as Christianity and democracy, and Christianity and economics. His main research concern was his fieldwork in the Thabo Mbeki Village. He sadly passed away in December 2018 after a long battle with cancer.

After a short period as teaching-assistant in the Department, Dr Tanya (T) van Wyk (2010 to date) was appointed as Senior Lecturer in 2014. Her main research theme, apart from developing political-theological sub-themes, is the post-modern space and the challenge within the space of reconciling diversity. She addressed ecclesial unity and catholicity, as well as issues of race, gender and sexuality.

All members of staff belonged to a number of international and national subject societies over this period<sup>3</sup> and were also involved in international research collaborations. Perhaps one of the most prominent was the Expert Seminar with the Vrije Universiteit, Amsterdam (the Netherlands) in 2005 which resulted in several further collaborations. Staff were also invited on more than one occasion, as visiting scholars to the US, Germany, Korea, Brazil, the UK and Hungary. In this period alone, they published more than 200 articles in accredited journals and over 50 books and chapters in books. Just over 130 postgraduate students completed their studies in the Department.

<sup>3</sup> Organisations have included the International Reformed Theological Institute (IRTI), the American Academy of Religion (AAR), European Society for the Study of Science and Theology (ESSSAT), the Theological Society of South Africa (TSSA).

There were two eminent scholars who were recipients of honorary doctorates motivated by the Department during this period, Prof Klaus (KB) Nürnberger in 2012, and Prof Jürgen (JD) Moltmann in 2018.

### 3. New Testament Studies

In 2018 the name of the Department changed from the Department of New Testament Studies to the Department of New Testament and Related Literature. This name change highlighted the fact that the Department also focuses on texts that are not part of the New Testament canon; texts that are especially important in an historical interpretation of the New Testament and its world.

In the period 2009 to 2018, the Department of New Testament and Related Literature had the following staff members: Prof Jan (J) van der Watt (resigned in 2009), Prof Gert (GJ) Steyn (2003–2017), Prof McGlory (MG) Speckman (2004–2016), Prof Ernest (E) van Eck (from 2006), Prof Kobus (JK) Kok (2009–2015), Dr Elijah (E) Mahlangu (2011–2014), Dr Zoro (ZZ) Dube (appointed in 2016), and Dr Hanré Janse (HJ) van Rensburg (appointed in 2017).

Prof Steyn succeeded Prof Van der Watt, first in an acting capacity, and from October 2010 to 2017 as the new Head of Department. Prof Steyn retired in 2017, and Prof Van Eck was appointed in 2018 as the new Head of Department.

During the period under review, the Department successfully supervised 30 masters and 44 doctoral students, and published 466 research articles. Added to this, the following monographs were published:

- Steyn GJ. 2015. *A quest for the assumed Septuagint Vorlage of the explicit quotations in Hebrew* (Göttingen: Vandenhoeck & Ruprecht)
- Van Eck E. 2016. *The parables of Jesus the Galilean: Stories of a social prophet* (Cascade Books, Eugene)
- Kok JK. 2016. *New perspectives on healing: Restoration and reconciliation in John's gospel* (Brill Academic Publishing).

The Department is internationally recognised for its contribution to research on several topics of the New Testament, for its training of ministerial candidates, and for teaching on the New Testament to students who are interested in religious studies. The Department is one of the leading and largest departments in New Testament Studies at residential universities in South Africa and attracts not only a considerable number of postgraduate students from across

the globe, but also some of the most prominent international specialists as honorary professors and research associates. The Department has a long-standing history of qualitative contributions in the areas of New Testament exegesis and hermeneutics with close involvement, participation and leadership in New Testament societies nationally and globally.

The specialist foci of staff members for the period under review were in the areas of historical Jesus and parable research, New Testament ethics, gender studies, the gospel of John, sexuality in the New Testament and related literature, Hellenistic Judaism (especially the Septuagint and Philo of Alexandria), apocalyptic literature, ritual, Jesus as healer, and healing in an African environment. The members of the Department were committed to a holistic approach in exegetical and hermeneutical studies of the New Testament, and used synchronic, diachronic, reader-response and social-scientific approaches to the study of the New Testament corpus.

Apart from their own research, lecturers were also dedicated to the supervision of postgraduate students, many of whom were from all over the world. The Department promoted contextual research where applicable and, as evidenced by previous doctoral students, members of the Department could supervise students on any topic related to the New Testament.

The Department remained committed to quality research and teaching. The Department's full-time lecturers, research associates, and extraordinary professors were of international standing and regularly participated on invitation at international conferences. Most of the members of the Department were involved in editorial committees of scholarly journals and book series, as well as in the assessment of submissions for publications, and regularly acted as external examiners.

### 4. Old Testament Studies

Prof Pieter (PM) Venter was Head of the Department of Old Testament Studies (OTS) for the period 2009 to 2012. He was succeeded as Head of Department in 2012 by Prof Dirk (DJ) Human who continued to serve in this capacity until 2018. Prof Human was previously Programme Manager of Religion Studies (2000–2012).

Prof Alphonso (A) Groenewald joined OTS in a permanent position in 2006. He initially specialised in the Book of Psalms, but later directed his academic focus to the prophetic

literature, especially the book of Isaiah. Prof Sias (EE) Meyer was appointed in 2010 as successor to Prof Jurie (JH) le Roux. He specialised in the Priestly Code and aspects of the book of Leviticus and was the Pentateuch specialist in the Department. In 2012, Prof Ananda (A) Geysler-Fouché succeeded Prof Venter. With specialisation in Qumran Studies and the book of Chronicles, her academic foci became the Second Temple and OT wisdom literature. Dr Gerda (G) de Villiers was the second woman to be appointed in 2015. Her teaching responsibilities resided in the Faculty's programme for Religion Studies, from whence her expertise in ancient Near East religions was foregrounded.

During this review period, the Department continually reinterpreted and verbalised its position in Africa, since Africa is different from other continents in several ways and therefore different questions need to be pursued. In this regard, Dr Sam (SS) Ndogo contributed enormously to this endeavour as honorary senior lecturer in Old Testament Studies since 2015.

Honorary scholars were Profs Eckart (E) Otto (Munich, Germany) and James (JA) Loader (Vienna, Austria). Extraordinary appointees were Profs Thomas (T) Römer (Paris, Lausanne, France), Ulrich (U) Berges (Bonn, Germany), Christian (C) Frevel (Bochum, Germany), Aloo (AO) Mojola (Limuru, Kenya) and John (JJ) Collins (Yale University, US).

Several national and international research associates and postdoctoral fellows were active in the Department during the review period. During this period, the Department motivated for the conferral of an Honorary Doctorate on Prof Willem (WAM) Beuken, which honour was bestowed in 2016.

The academic strength of the Department was emphasised by a series of academic projects, which included:

- The ProPent (Project Pentateuch) seminar which originated in 2001 under the auspices of Profs Le Roux and Otto (Munich). Since then, this annual seminar has gained international recognition and has taken place in Pretoria, Munich, Vienna and Stellenbosch. As Pentateuch specialist, Prof Meyer served as a young additional member on this formidable organising team.
- The ProPsalms (Project Psalms) seminar started in 2003 with Prof Human as patron. This annual seminar has also taken place in Pretoria, Munich, Vienna and Stellenbosch.
- The ProProf (Project Prophets) seminar started in 2013 with Prof Groenewald as academic driver and initiator.
- In Qumran Studies, an international seminar started in 2015 with the appointment of Dr Geysler-Fouché as specialist of Second Temple and apocalyptic literature. Since then, international conferences and books have emanated from the project, inter alia in collaboration with the renowned Yale scholar, Prof Collins, who was also appointed as honorary professor in the Department in 2018.
- Since 2012, African Contextual Hermeneutics has been an increasingly important part of the academic activities and programmes. The theme has constantly been addressed in the curriculum, seminars, conferences and postgraduate studies. The contributions of Dr Ndogo, and Profs Emmanuel (EO) Usue (Makurdi, Nigeria), Mojola (Nairobi, Kenya) and Itumeleng (IJ) Mosala have been vital.



The Department has prioritised international interaction, African involvement and the inter- and the transdisciplinary character of its academic projects. Official academic relationships existed with about 40 international institutions in Africa, the US and UK, Europe, Jerusalem and Asia during the period under review. Projects on African Hermeneutics and the OT's relation to the Ancient Near East received special focus in the Department's teaching activities. International conferences held on the themes of suffering (2009), poverty (2014–2015), land issues (2016) and (in)justice (2017) underscored the Department's academic intention to be contextually relevant in Africa.

As a subject in Theology, OTS can be regarded as a special-skills field of study. Apart from the Semitic languages, Hebrew and Aramaic, the subject requires expertise in various aspects of Ancient Near Eastern languages and knowledge. Candidates for ministerial education are required to have Hebrew 2 as prerequisite.

Over many years, the Department has built a special relationship with the South African Bible Society, due to its participation in Bible translation. Apart from core contributions to the Afrikaans and isiNdebele translations, the Bible for the Deaf, the Bible for All, and Bible Concordance by former and current staff, a new project, *Die Bybel 2020*, includes contributions of several staff members.

Old Testament Studies contributes to all the programmes of the Faculty, which include the Diploma and Bachelors (BTh, BDiv) qualifications, and honours, master's and PhD degrees. In addition to the traditional master's and doctoral (Old Testament Studies) programmes, new qualifications were initiated in 2018 in the form of master's and doctoral programmes in Biblical Studies.

## 5. Practical Theology

In 2009, Prof Julian (JC) Müller was the Head of the Department of Practical Theology. He was succeeded by Prof Yolanda (Y) Dreyer in November 2010. She held the position until the beginning of 2015 when she was succeeded by Prof Cas (C) Wepener. Other full-time members of the Department during the period were Prof Maake (MJ) Masango, Prof Johann (JA) Meylahn and Rev Moganetsi (M) Makulubele. The Centre for Contextual Ministry, which was established by Prof Malan (M) Nel in 1993 at the Vista University, moved to the University of Pretoria and was incorporated into the Department of Practical Theology in 2002. Prof Nel headed the Centre until 2012 when he was succeeded by Dr Stephan (S) de Beer.

The discipline of Practical Theology is about faith practices. The Department specifically focused on researching faith practices in Sub-Saharan Africa, the continent of the Spirit and the spirits. It aimed to open up an academic space in which the experience of 'life in the Spirit' can be investigated by means of a methodology not based on a reductionist worldview, but one which dares to be holistic and include the African worldview of the world of the Spirit and the spirits. The Department aimed to be a hospitable academic space, known for critical thinking going beyond the boundaries. Through academic discourse, the objective was to penetrate to the root of social problems rather than revert to superficial quick fixes. The subject field lends itself to in-depth reflection on transformational praxis in order to bring about a radical shift in thinking and attitudes rather than just being satisfied with equity strategies. The aim was to break free from the binary oppositions of modernism rather than merely attempting to be an antonym for exclusivity.

Prof Müller, an NRF B-rated scientist, was involved in the Ubuntu research project in collaboration with the Faculty of Law, the Faculty of Humanities, and the Centre for the Advancement of Scholarship. The project was funded by the Templeton Foundation from the United States. A large number of publications stemmed from this project and a significant number of postgraduate students of all three faculties were involved. Prof Müller also attracted many students with his postgraduate Narrative Pastoral Therapy programme.

Prof Masango obtained international acclaim for his work on African pedagogy and pastoral care in African contexts. He recruited and supervised a large number of master's and doctoral students with his Trauma Counselling programme, which was specifically directed toward African contexts.

Prof Nel, whose focus was on congregational studies and youth ministry, published extensively in both fields. His monograph, in which the two are combined, *Youth Ministry: An Inclusive Missional Approach*, was published in 2018. Prof Nel supervised a large number of international postgraduate students, mostly from the United States and other African countries.

Prof Dreyer was rated C2 by the National Research Foundation in 2014. Her research focus areas include pastoral care, gender, power and sexuality, spirituality and mental health. She collaborated with scholars in the US, Korea and Brazil in the research project, 'New Directions in Pastoral Theology' at the Princeton Theological Seminary from 2013 to 2018.

Prof Wepener was a Y2 NRF-rated scholar until 2011, and obtained a C2 rating in 2012. He is known for his empirical research on African liturgical practices and ritual studies. His prolific literary output includes scholarly work, popular scientific work, which is widely used in churches, and creative writing.

Prof Meylahn was appointed as senior lecturer in the Department in 2010, and was promoted to associate professor in 2012 and full professor in 2016. His research focus is the conversation between philosophy and religion (theology) in response to various contextual challenges. Prof Meylahn obtained a second doctoral degree from the Vrije Universiteit, Amsterdam (the Netherlands), in 2011 in the field of Philosophy of Religion.

The work of Dr De Beer and the Centre for Contextual Ministry focused on faith in the city, street homelessness, social justice and reconciliation, child theology, as well as on spirituality and health. The mission of the Centre was specifically to provide continued education to pastors and faith-based leaders at grassroots levels. This was achieved through decentralised courses as well as specialised one- and two-year programmes that focus on congregational development, pastoral care, youth ministry and preaching.

## 6. Science of Religion and Missiology

The Department of Science of Religion and Missiology (SRM) has carried the name since 1953. In 2009, the Head of the Department, Prof Piet (PJ) van der Merwe retired and was succeeded by Prof Nelus (N) Niemandt. The Department benefited from the research contributed by Dr Attie (AS) van Niekerk and Prof Thias (ST) Kgatla, who both retired during this period.

The programme, Biblical and Religious Studies (BRS), which had existed since 1984, was hosted in the Faculty of Humanities but staffed by the Faculty of Theology. The programme manager during this period was Prof Dirk (DJ) Human, who was replaced in 2013 by Prof Jaco (J) Beyers who joined UP in 2011, at which time, plans to move the BRS programme to the Faculty of Theology had commenced. In 2017, when the Faculty name changed to the Faculty of Theology and Religion, and coinciding with the Faculty centenary celebrations, it seemed an appropriate time to migrate the BRS programme to the Faculty of Theology and Religion, in order to give expression to the new inclusive

direction the Faculty was heading in. The BRS programme was placed in the traditional department of Science of Religion and Missiology, under Prof Niemandt.

The focus in the Department of Science of Religion and Missiology was divided between three disciplines: Missiology, Science of Religion and Religion Studies. In Missiology, research proceeded in *missional* ecclesiology and *missional* leadership, which was to the benefit of several faith communities. A number of postgraduate students completed their research in these areas under the expert supervision of Prof Niemandt. There has always existed a close tie between the disciplines of Missiology and Science of Religion, which focused on the study of the phenomenon of religion and inter-religious relations, as seen from a theological perspective. Religion Studies, as the third discipline, focused on studying world religions, secularisation and sociology of religion. This required a specific methodology. Phenomenology became an important way of studying world religions, resulting in religious education and not doctrinal religious instruction.

The merger between Science of Religion and Religion Studies made several research projects possible. The research was complemented with the addition of Dr Maniraj (M) Sukdaven who joined the Department in 2014. Inter-religious encounters, in particular between Christians and Muslims worldwide, became an important research project. Members of the Department have, since 2016, participated in the international Christian-Muslim Relations (CMR) 1900 project to record all written accounts between Christians and Muslims over centuries.

Religion Studies always had strong ties with the Faculty of Education as students enrolled for the programme because it was a school subject. As an elective course, the programme served the whole campus community. Part of the vision of the Department is to stimulate conversations on campus about religious matters in order to create awareness and sensitivity for religious diversity in an attempt to create social cohesion. Through regular public lectures open to the campus community as well as the broader society, the Department created opportunities for active debate on religious matters.

Religion Studies always had a strong postgraduate component with opportunities presented for scholars from non-Christian religions to enrol for postgraduate studies. During this period, several PhD students from a diverse field of religions, including Buddhism, Judaism and Islam, completed their PhD studies in the Faculty.



## 9 | Veterinary Science

### DEAN'S OVERVIEW

The period 2009 to 2019 marked the second decade of the re-established Faculty of Veterinary Science following the amalgamation of the faculties of Veterinary Science of the University of Pretoria and the Medical University of South Africa (Medunsa) in 1999. The amalgamation made the Faculty the only national Faculty of Veterinary Science in South Africa and the sole place for training towards the professions of veterinary science, veterinary specialists and veterinary nursing. For this 10-year period, the Faculty trained 1 481, 431 and 80 veterinarians, veterinary nurses and specialists respectively, which approximately doubled the number of professionals in these fields in the country. For the specialists, the training also spanned over 20 disciplines, ranging from small animal surgery to veterinary pharmacology.

This period saw the largest veterinary nursing and veterinary classes graduate, with 51 and 169 graduates in 2018 and 2019, respectively. The Faculty continued to strengthen its standing as a veterinary training facility in South Africa with the ultimate goal of being the top veterinary teaching and research facility in Africa. Three Deans were responsible for the Faculty for the review period, namely Prof Gerry (GE) Swan who completed his second term in 2014, Prof Darrell (DA) Abernethy who completed a single term from 2014 until 2018, and Prof Vinny (V) Naidoo who served as Acting Dean for a brief period until his appointment on 1 August 2018 as Dean.

The period was also marked by extensive change to the senior management of the Faculty, which included the appointments of:

- Four Academic Heads of Department: Prof Tshepo (PT) Matjila — Veterinary Tropical Diseases (2015), Dr Rebone (R) Moerane — Production Animal Studies (2017), Prof Amelia (A) Goddard — Companion Animal Clinical Studies (2018), and Prof Joseph (JP) Chamunorwa — Anatomy and Physiology (2018).
- Two Hospital Directors: Prof Henry (CH) Annandale (2008), and Dr Paul (PEA) van Dam (2019).

New senior management appointments also included change at the level of Deputy Deans:

- Prof Koos (JAW) Coetzer (2012) — Research, Postgraduate Studies and Internationalisation; and Prof Dietmar (DE) Holm (2016) — Teaching and Learning
- Prof Vinny (V) Naidoo (2015) and Prof Marinda (MC) Oosthuizen (2019) — both Research and Postgraduate Studies.



Prof Gerry Swan | Dean, 2005-2014

With transformation as a major focus, the Faculty saw, for the first time in its history, the appointment of two female and four black senior management staff.

### The Onderstepoort Campus

For its operations the Faculty is housed on a satellite campus at Onderstepoort in the north of Pretoria. The Onderstepoort Campus is a wholly self-contained campus that houses:

- Five academic departments — Anatomy and Physiology, Companion Animal Clinical Studies, Production Animal Studies, Paraclinical Sciences, and Veterinary Tropical Diseases — and their extensive research laboratories
- A comprehensive specialist referral veterinary hospital
- Three research centres — the Centre for Veterinary Wildlife Studies, the Equine Research Centre and the Exotic Leather Research Centre
- An animal research centre
- An animal teaching unit, and
- Student residences.

### Rural platforms

Despite being in Onderstepoort for the greater part of its existence, the Faculty started expanding in late 2008. The first external facility was the Hluvukani Clinic in Bushbuckridge, in the Mpumalanga province, which the Faculty took over from the province, in 2009, for student elective clinical training. This formed part of the Mnisi programme and enabled the Faculty to offer training at a rural veterinary clinic, as well as to give students the opportunity to manage production animals in an endemic Foot-and-Mouth area.

The Faculty subsequently opened an animal welfare clinic on the University's Mamelodi Campus, in 2011, to offer training in veterinary welfare medicine.



Prof Darrell Abernethy | Dean, 2014-2018

The largest addition to the Faculty took place in 2010 when the Faculty started working out of the refurbished Hans Hoheisen Wildlife Research Station, which is situated at the Orpen Gate of the Kruger National Park. The facility was made available through a memorandum of understanding with the Mpumalanga Tourism and Parks Agency and the Peace Parks Foundation. This facility has allowed the Faculty unique research opportunities as it is located, as is the Hluvukani

Table 4.3. Faculty of Veterinary Science profile of students, 2009 to 2018.

Indicators	2011	2012	2013	2014	2015	2016	2017	2018
Total UG headcount enrolments	635	814	814	895	914	960	1022	1043
% black UG enrolments	11,5%	15,5%	18,3%	22,2%	26,5%	29,0%	32,7%	35,0%
Module Pass Percentage	98,2%	97,7%	97,8%	98,3%	97,6%	98,1%	97,7%	97,7%
Total PG enrolments	275	284	269	308	307	323	310	338
% black PG enrolments	45,5%	48,9%	47,2%	47,4%	50,5%	49,8%	51,5%	50,6%
% black M and D graduates	44,4%	58,8%	35,6%	54,3%	49,1%	49,1%	37,5%	57,1%



Prof Vinny Naidoo | Dean, 2018 and beyond

Clinic, in an endemic Foot-and-Mouth area, in addition to being at the interface between wildlife and cattle farming. The station has lecture facilities, a library, molecular laboratory, a BSL2 disease laboratory, a biobank and associated housing facilities for staff and students. In 2012, clinical services were further expanded into the greater Onderstepoort area, when two specially modified mobile ambulatory units were added to the Production Animal Clinic (PAC) of the Onderstepoort Veterinary Academic Hospital (OVAH).

### Accreditation and oversight

There were complexities associated with the Faculty of Veterinary Science being the only faculty of its kind in the country, which has meant that benchmarking cannot be against local offerings. To ensure that the courses and programmes on offer were of high international standard, the Faculty enjoyed accreditation with the South African Veterinary Council (SAVC), the Royal College of Veterinary Surgeons (RCVS) in the United Kingdom, and the Australasian Veterinary Boards Council (AVBC) in Australia and New Zealand. During the review period the Faculty had one major and one intermediate accreditation visit, in 2013 and

2015 respectively. In addition to maintaining international accreditation, these visits afforded the Faculty insight into international trends in veterinary education, which resulted in substantial changes to the curriculum. In 2015, the Faculty was also inspected by the Namibian Veterinary Council, which has subsequently allowed UP qualified veterinarians immediate practice in Namibia on graduation.

In addition to the accreditation process, to further enhance governance at the Faculty and to ensure the relevance of training programmes to the veterinary industry of South Africa, the UP Senate approved the establishment of a Faculty Advisory Board which hosted its inaugural meeting in 2010. The Advisory Board, chaired by the Vice-Principal: Academic of the University, is composed of representatives from the Department of Agriculture (DoA), the South African Veterinary Association (SAVA), the Agricultural Research Council (ARC), the Black Veterinary Forum (BVF), AgriSA, Wildlife Ranching South Africa (WRSA) and private practice. The Board continued to set the overarching priorities for the Faculty, of which food safety and enhancing diversity in the profession were the most important during this period.

### Curriculum change

Despite the training of veterinarians in South Africa since 1920, when the Transvaal University College (TUC) admitted the first student, a major challenge remained the under-representation of black students. In 2009, only 12,2% of undergraduate students were black, as is reflected in Table 9.1. By 2018 this had increased to 34,2% and 50,1% of postgraduate students enrolment.

A major barrier, at the time, was perceived to be the new double degree structure introduced in 2008, namely a three-year BSc (Veterinary Biology), followed by a four-year Bachelor of Veterinary Science (BVSc) degree. The view was that the cost associated with the seven-year programme, and the associated difficulty of students needing to obtain two bursaries to complete their veterinary training, was an obstacle especially for students from poor and working class backgrounds. Concern was also raised about the inadequate focus of the programme on food production. In 2009, Senate approved a new six-year BVSc degree that was implemented in 2011. The new degree was designed as a core-elective curriculum with a greater focus on food production, together with a requirement for students to complete four months of their final year clinical training in a specific field with the aim to enhance the number of veterinarians working in food production.



To enable transformation of the profession, the Faculty has implemented numerous initiatives to attract black students into the programme over the years. Specifically worth mentioning is the 'I want to be a Vet' weekend that was started in 2009, facilitated by the Faculty house, the Onderstepoort Veterinary and Paraveterinary Student Committee (OPVSC). This student-driven initiative, now a fixed feature on the Faculty timetable, has the sole purpose of extending awareness of veterinary science and its related fields to learners from disadvantaged communities across South Africa. For the programme, prospective students are brought onto campus and introduced to the skills of basic animal handling for different species of animals, including dogs, cattle, sheep and horses. The learners are also exposed to clinical aspects such as veterinary anatomy and pathology. The programme has been of tremendous benefit to the Faculty by allowing participants with limited animal interaction experience to consider veterinary science as a prospective career.

### Expansion

A major discussion during the review period focused on the optimal number of veterinarians that the country needed to train. An important outcome was the report, 'Veterinary Science programmes in South Africa — collaboration between training institutions' (2011), prepared by a working group chaired by the Vice-Chancellor and Principal, Prof Cheryl de la Rey. The report recommended an increase in the number of veterinarians trained at the Faculty to meet skills shortages. Following discussions with the Department of Higher Education and Training (DHET), approval was granted to increase the number of veterinarians trained to approximately 190 graduates per year. To facilitate this process, the Faculty embarked on an extensive campus improvement plan, which included the addition of a new computer facility, a multi-disciplinary laboratory, a skills laboratory, a student centre, a new home for student administration, new student health facilities, and the expansion of the residences.

<sup>1</sup> Also known as the Shanghai Global Ranking.

<sup>2</sup> <https://www.iso.org/standard/66912.html>

The new Lesedi complex, which contains many of the additions to the Faculty, was opened in 2013. Among others, the complex houses the new skills laboratory which opened in 2015. It was one of the spearhead initiatives in teaching and learning that makes use of advanced lifelike models for student training. It also allows for the practice of skills in a controlled environment, before students are permitted to work on animals, especially client-owned animals. The laboratory has offered many benefits to animal welfare as it reduces the number of animals needed for training. Furthermore, it has allowed the Faculty to introduce research into the scholarship of teaching and learning through a protocol evaluation of training initiatives, such as the ovariohysterectomy and pregnancy diagnosis models which were developed for the skills laboratory.

### Veterinary nursing

The further major undergraduate programme change was the introduction of a three-year Bachelor's degree in Veterinary Nursing (BVN), which was approved by the Council on Higher Education (CHE) in 2017, after 15 years of discussion. The new degree replaced the two-year Diploma in Veterinary Nursing (DVN), which had been on offer for over 40 years. Among the reasons for the decision was that the two-year diploma did not allow students to pursue any form of postgraduate study, and therefore resulted in an academic dead-end for diplomates. The new degree now offers more opportunities to graduates at the postgraduate level and offers the profession the opportunity to consider the introduction of specialist veterinary nurses as a future profession in the country.

### Research achievements

The Faculty saw a major improvement in research productivity since 2009 in all the major indicators: contract income had increased from R28,3 million to R65,8 million; NRF-rated researchers from 17 to 39; publication units from 82 to 111; and PhDs awarded from nine to 22. Aligned with the increase in research output, the Faculty goal of being a top research facility was achieved when it was placed 30th globally in the Academic Ranking of World Universities<sup>1</sup> (ARWU) Subject Ranking in 2017. The Faculty was also ranked 43rd in the Quacquarelli Symonds (QS) Ranking of Veterinary Schools in 2019.

During this period four research themes were identified to strengthen collaboration across disciplines, and the Faculty's position in competing for large international grants:

- African Wildlife Health and Management
- Public Health and Well-being
- Translational Medicine
- Pathobiology of Disease.

In overview, the following with respect to research entities:

- The Equine Research Centre (ERC), the oldest research centre in the Faculty, celebrating 25 years of outstanding research contributions to equine health and disease diagnosis in the country, under the stewardship of Prof Alan (AJ) Guthrie.
- The Exotic Leather Research Centre (ELRC) which was established to enhance the post-production value chain for leather, harvested from crocodiles and ostriches with Prof Swan as Director.
- The Centre for Veterinary Wildlife Studies (CVWS) had a change in directorship and focus with the appointment of Prof Leith (LCR) Meyer in 2017.
- In 2013, through collaboration with the South African Poultry Association, the Poultry Disease Management Agency was established in the Faculty, with the appointment of Prof Celia (C) Abolnik as a senior researcher in the programme.

In 2017/2018, the Faculty had its first DST-NRF SARCHI Chair approved, with Prof Abolnik appointed as the incumbent of the Chair in Poultry Health and Production. The programme was soon expanded after being awarded a Community of Practice grant worth R7 million to support sanitary risk assessment aimed at improving veterinary disease management in the country.

The period also saw a partnership with the Department of Veterinary Tropical Diseases (DVT) and the Institute of Tropical Medicine (ITM) in Antwerp, Belgium grow in strength. The partnership started in 2002 at R6.5 million and was expanded to an R80 million programme from 2018 onwards. The research programme was based on the principles of One Health and included research master's and doctoral programmes and short courses, together with the joint offering by UP and ITM of a coursework master's degree with shared modules between the institutions.

With the success of the programme, a collaborative MSc (Tropical Animal Health) was introduced in 2016.

## Research facilities

The Faculty has always maintained top quality research facilities to enable research at the highest standard. To further strengthen the operations of laboratories, the Faculty embarked on the process of getting the key laboratories accredited in terms of ISO17025<sup>2</sup>. Accreditation is important as it allows the Faculty to offer a high quality diagnostic service that not only supports the veterinary industry but also allows the Faculty to undertake research into high impact veterinary diseases. Through its members, the national standards bodies in 167 different countries, the International Organization for Standardization (ISO) brings together experts from across the world to develop International Standards.

In 2015, the Bacteriology, Serology, Parasitology and Virology laboratories of the Department of Veterinary Tropical Diseases (DVTD) were the first to be accredited by the South African National Accreditation System (SANAS). More laboratories have since been added. The most recent addition was the diagnostic laboratories of the Equine Research Centre. The latter was a major achievement as the test introduced was not only developed and validated by the Faculty, it was approved, in 2017, as an international diagnostic test for African horse sickness (AHS) by the World Organisation for Animal Health (OIE). The new test reduced the time it takes to test for the disease from two weeks to four hours. This not only minimises the time needed for quarantine before an animal can be transported, it also enhances the laboratory diagnosis of AHS by increasing the sensitivity of detection.

## Overview of performance

From 2008 to 2016, 64 MSc and 13 PhD students successfully completed their studies under the umbrella of the FA3 Framework Agreement. In addition, 70 papers were published in international journals. For the period 2017 to 2019, 65 MSc (Tropical Animal Health), 13 research MSc, 14 PhD and seven postdoctoral students enrolled in the programme and were

directly supported under the umbrella of the FA4 Framework Agreement. This partnership was funded under the umbrella of Framework Agreements between the Directorate-General for Development Cooperation (DGDC) and the Institute for Tropical Medicine (ITM) in Belgium.

The infographic on pages 384 and 385 provides further detail on performance during the period 2009 to 2018. In summary:

- Overall enrolment increased from 910 in 2009 to 1 381 in 2018.
- The proportion of black students at undergraduate levels increased from 11,5% to 35% over the same period, and at postgraduate levels from 45,5% to 50,6%.
- Undergraduate headcount enrolment increased from 635 in 2011 to 1 043 in 2018, including veterinary nursing students, while postgraduate numbers increased from 275 in 2009 to 338 in 2018. This is due to the curriculum change that combined two sequential bachelor and honours degrees into one Bachelor of Veterinary Science programme.
- Master's and doctoral graduates increased from 45 in 2009 to 98 in 2018, and weighted M and D research output increased from 0,38 in 2009 to 1,43 in 2018.
- PhDs awarded increased from nine in 2009 to 22 in 2018, and the number of NRF-rated researchers in 2018 were 38 scientists, which presents a strong increase from 18 in 2009.

At an international level, the Faculty of Veterinary Science's position in two world ranking systems reflects the stature it maintained during this period: in 2017 it was rated 30th globally in the ARWU Subject Ranking, and 43rd in the QS Ranking of Veterinary Schools in 2019. In turn, at a local and regional level, the Faculty's rural and township platforms have allowed for students' clinical training and contexts highly relevant to South Africa and the region.

**Prof Vinny Naidoo** | Dean, 2018 and beyond



## VETERINARY SCIENCE: PERFORMANCE AT A GLANCE

### Enrolment and success

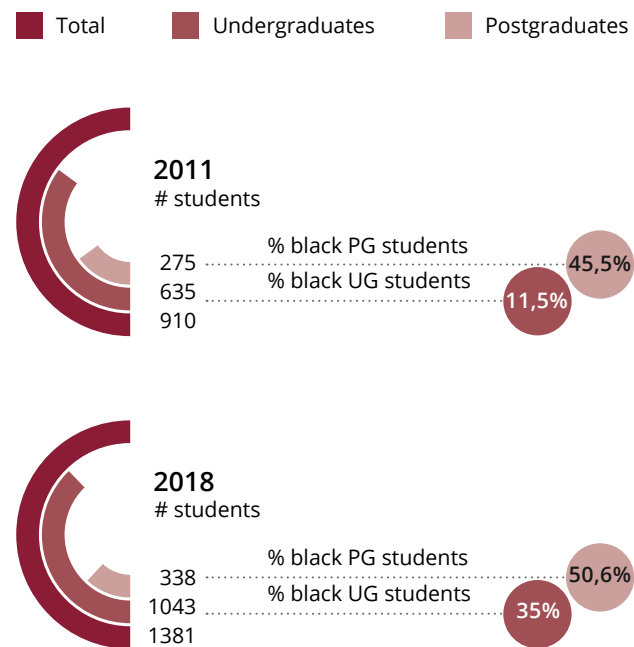

### Undergraduate module pass %

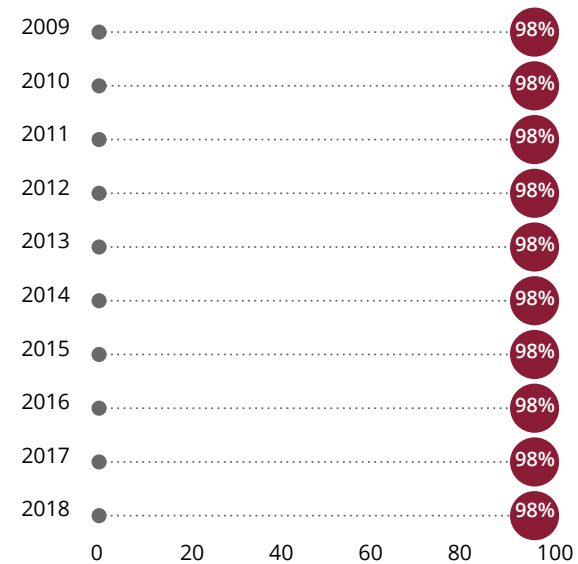

### UG graduates

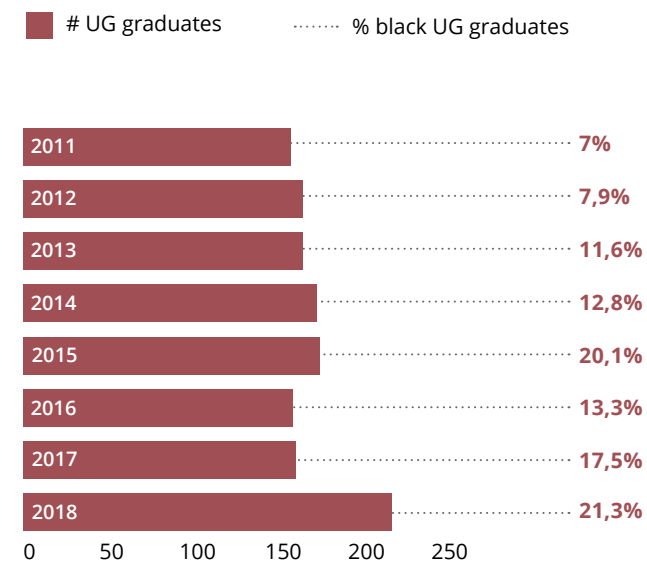

### Student : staff ratio

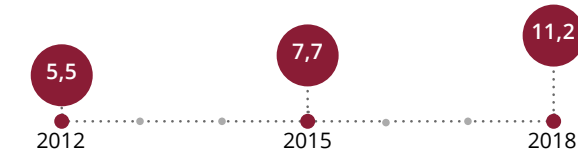

### Weighted M and D output

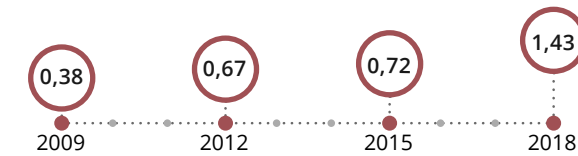

### Research pipeline

#### M and D enrolment

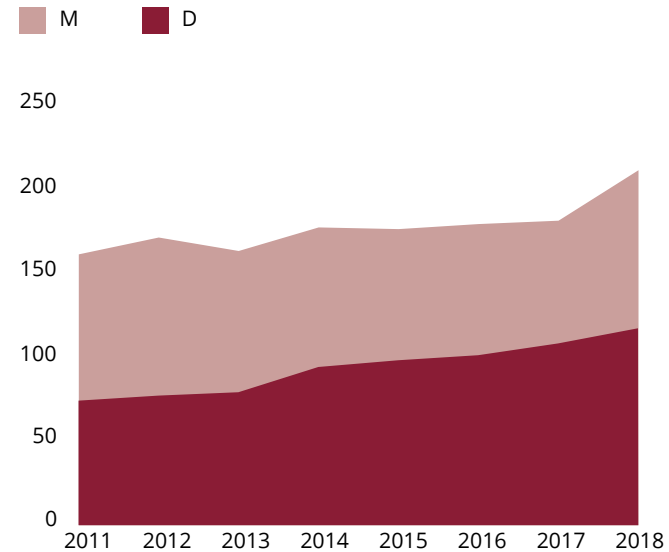

#### M and D graduates

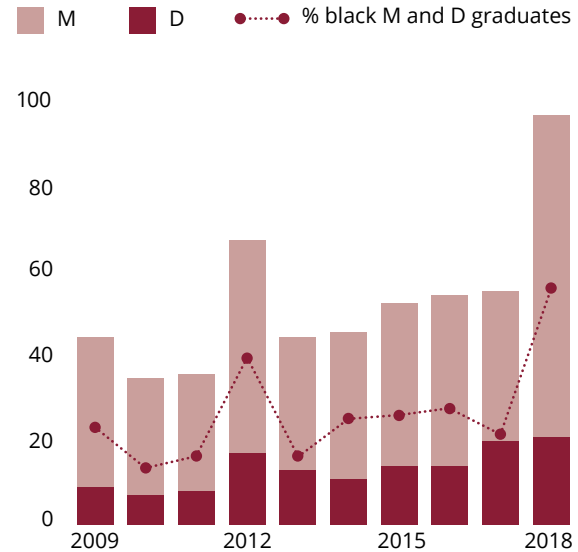

### Capacity and productivity

#### % Academic staff with PhDs

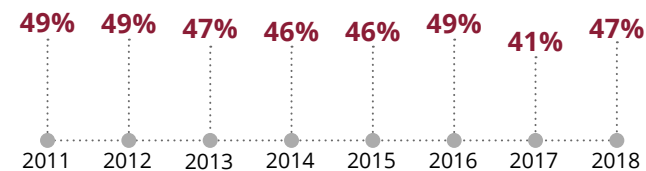

#### NRF-rated researchers, 2018



#### Research output

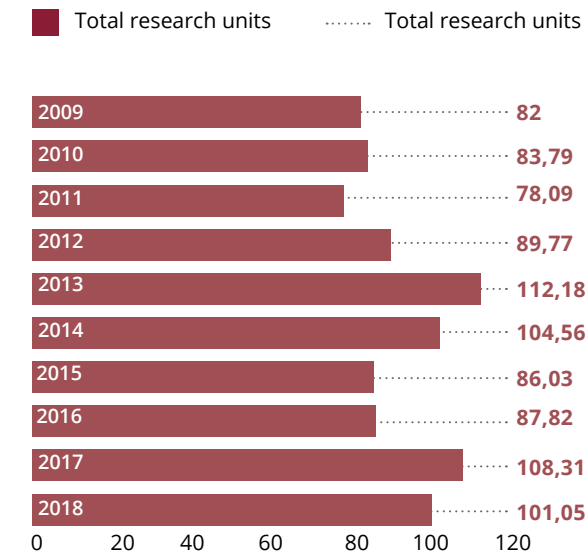



## DEPARTMENTS

### 1. Anatomy and Physiology

The Department of Anatomy and Physiology operated, until 2015, with two leadership positions — a head of department and a section head of Physiology — when the headship of the Physiology section was terminated in favour of one leadership position. At the same time, all staff were relocated to the Faculty's Anatomy Building — a process that was concluded in 2018. Prof Herman (HB) Groenewald was the Head of Department from 1999 to 2015. Prof André (A) Ganswindt was the Acting Head from 2016 to July 2017, until the appointment of Prof Joseph (JP) Chamunorwa, first in an acting capacity from 1 November 2017 to 31 August 2018, and then as Head of Department from 1 September 2018.

The academic assignment of the Department remained teaching preclinical veterinary students, veterinary nurses, postgraduate students (MSc and PhD) and research. In 2016, the academic staff complement was reduced from six to four in Anatomy, and from four to the three in Physiology.

#### Teaching and research

In teaching, the Department distinguished itself during the review period by employing and adopting contemporary methods of instruction and moving lectures and content to the virtual online and digital media environment. This move was useful during the #FeesMustFall student protests when lectures needed to continue online. Histology slides were digitised and close to 90% of histology practicals conducted on a digital basis.

Acknowledgement of this innovative approach by the Department can be found in the accolades staff in the Department received at faculty and university levels.

The Department also initiated the establishment of a plastination laboratory in 2016/2017, which started producing anatomical specimens from 2018. The laboratory was now one of only two active plastination laboratories in the country.

Research formed the backbone of teaching and the Department was active in several topical research areas during this period, which included:

- Anatomy and immunohistochemistry studies of the reproductive organs in birds (Japanese quails, ostriches and emus)

- Anatomy and physiology of different aspects of wildlife species (pangolin, lion, elephant, spring hares, ostriches and emus, to mention a few), and
- Fat accretion in emus, pancreatitis in the Nile crocodile and the importance of the vomeronasal organ in the physiology of reproduction.

Postgraduate training is what fuels the research agenda of academic departments and this Department was no different. During the review period, each project or topic listed above was tied to the training of master's and PhD students.

#### Highlights

Highlights included a paper published in *Nature Communications* on the elephant trunk. Due to the high impact of this research, the Department intended to continue with this as a major research project with the ultimate focus on robotics. This project seeks to incorporate physics of the fourth industrial revolution (4IR) in artificial intelligence (AI) and design a robot that has capabilities based on the agility and precision of the elephant trunk in picking up objects and in selectively distinguishing between objects.

On grantsmanship, the Department received considerable amounts of funding in cash and in-kind with the highlight being the R3 million awarded to Prof Mary-Catherine (M-C) Madekurozwa for the period 2017 to 2019, which focused on the reproductive toxic effect of specific chemicals in the environment.

Over the ten years, the Department had two C3 NRF-rated and one Y-rated academics.

### 2. Companion Animal Clinical Studies

The Department of Companion Animal Clinical Studies, the largest department in the Faculty of Veterinary Science, consists of seven sections: small animal medicine, small animal surgery, equine medicine and surgery, diagnostic imaging, anaesthesiology, clinical pathology, and ethology.

In March 2009 Prof Piet (P) Stadler finished his second term as Head of Department and was succeeded by Prof Johan (JP) Schoeman who served from October 2009 until September 2017. Prof Amelia (A) Goddard served as Acting Head until September 2018 when she was appointed as the first female Head of the Department.

During the period under review, the Department went through a high staff turnover, due to the allure of private practice for specialists in the various disciplines. The Department lost nine of its specialists during 2016, which resulted in the temporary closure of the equine medicine service and impacted on the equine surgery service. The service reopened at the beginning of 2018 after the appointment of three international specialists in equine medicine and surgery.

#### Teaching and research

The introduction of a computer software programme, Vetbox, allowed for greater flexibility around clinic bookings for students. It also had the added features of skills logging by the students, as well as assessment of the skills through direct observation of practical skills (DOPS). The coordination of the Veterinary Core Practice modules (VCP 520, 610 and 620) resorted under the Department. Teaching and learning, specifically student assessment, saw the dawn of a new era with the introduction of online instruction using the ClickUP software programme, as well as computer-based assessment. These changes necessitated a complete mind-shift by staff, especially those less familiar with advances in information

technology. Various training opportunities were offered by the Department of Education Innovation to assist.

The Department managed to improve on its average annual research outputs during this period, despite the high staff turnover. Research publication units doubled from approximately 8 to 10 units per year (in the years 2005 to 2008), to an average of about 19 for a number of years. This may be explained by the increased number of academic staff who obtained a PhD qualification during this period. Only one member of staff had a PhD in 2009; by the end of 2018, seven staff members had completed their PhDs and five more started their PhD programmes.

A concerted effort was made to increase MSc enrolments by recruiting recent graduates in their community service year. By 2018, the Department had a record number (59) of postgraduate students (MMedVet, MSc, PhD) enrolled. The honours degree was discontinued and replaced by a postgraduate diploma in 2018. Since 2018, the Department offered three postgraduate diplomas namely PGDip (Animal Welfare), PGDip (Veterinary Clinical Sciences) and PGDip (Veterinary General). The motivation was to increase postgraduate numbers and for the PG Dip to serve as a pipeline for both veterinary and non-veterinary candidates into an MSc degree.



## Highlights

During the period under review, 106 honours, 53 MMedVet, 30 MSc and 10 PhD degrees were conferred through the Department. A highlight was the increasing international collaboration with universities such as Copenhagen (Denmark), Ghent (Belgium), Edinburgh (Scotland), Cambridge (UK) and Colorado State (US) which led to numerous collaborative publications. Several more staff members published book chapters in international textbooks, and delivered keynote presentations and many research abstracts at international conferences. In addition, a dedicated clinical research space was created in the Department to foster a research culture, consisting of a fully furnished laboratory and study areas.

The training of specialists in the various disciplines remained constant over this period, mainly due to the fact that this is dependent on the availability of a clinical assistant post. At the start of the period, only three specialist training programmes (diagnostic imaging, anaesthesiology and small animal medicine) were accredited by their respective European colleges. This grew to seven during the period to include equine medicine, equine surgery, small animal surgery and clinical pathology. Four more staff members passed their international board examinations and another board-certified specialist was appointed in late 2016. This led to an unparalleled number of internationally accredited specialists (13) employed by the Department.

## 3. Production Animal Studies

The Department of Production Animal Studies provides teaching, research and clinical and referral services under six sections:

- Ruminant Health and Production that focuses on basic animal production, preventative herd/flock health, welfare and animal handling.
- The Production Animal Clinic that handles medical and surgical cases in the Onderstepoort Veterinary Academic Hospital (OVAH) and surrounding communities.
- The Reproduction Section whereby reproduction disorders and biotechnology services are provided.
- The Wildlife Section with a world-class facility to provide services to private wildlife landowners, government, NGOs and communities.

- The Poultry Section which provides diagnostic and specialist advice on key poultry animal diseases and management aspects.
- Veterinary Epidemiological Services that deals with all aspects of surveillance, investigations and research in animal populations of all species.

The Department had a staff complement of 54 at the end of the review period. Staff changes during this period included the position of Head of Department vacated and filled twice with the most recent Head of Department, Dr Rebone (R) Moerane, appointed in 2017, after Prof Pete (P) Irons who had served as Head of Department since 2009. Further, ten academics retired and were replaced, and the Onderstepoort Teaching Animal Unit (OTAU) that is responsible for the management of all animals used for student teaching and learning, was incorporated into the Department from February 2017. In this period, two industry-funded Research Chairs were established — the Chair for Poultry Health and Production (2013), and the Chair for Primary Animal Health Care (2011). The latter has been funded by Afrivet Business Management since its inception (R1 million per annum). The Chair in Poultry Health and Production was subsequently converted into the first SARChI Chair in the Faculty.

## Structural change

Several structural changes within the Department included the creation of a Biosecurity Level 3 Laboratory for Poultry (completed and commissioned in June 2014 at a cost of R1,8 million); the accreditation of the Milk Laboratory by SANAS since 2016, and approved by the Department of Agriculture, Land Reform and Rural Development since December 2010; the establishment of the Reproduction Veterinary Population Management Laboratory in 2013, with a particular focus on innovative immunocontraceptive vaccine development to be used in elephants; and the establishment of an In-Vitro Fertilisation Laboratory in 2015 which collaborates with international partners to develop assisted reproductive techniques (ARTs) for the conservation of the near extinct Northern white rhinoceros.

## Highlights of achievement

The research and teaching achievements in the Department during this period included seven academics who achieved NRF ratings, and the output of 83 master's and 19 PhD graduates. The Department also saw a doctoral degree



awarded to a veterinary nurse, for the first time in the history of the Faculty, when Dr Esther (E) Botha, who started working at the Faculty as a veterinary nurse in 1983, received her PhD in 2017 with seven other PhD graduates.

Further achievements included:

The Reproduction Section obtaining accreditation status from the American College of Theriogenology (ACT) Board and the European College of Animal Reproduction (ECAR), and two academics — Prof Ken (K) Pettey and Prof Rhoda (R) Leask in the Small Stock Section — were registered as specialists with the European College of Small Ruminant Health Management.

Two senior academics — Prof Peter (PN) Thompson and Prof Geoffrey (GT) Fosgate — were chosen as the Top Researchers

in the Faculty, and two academics received the Faculty Lecturer of the Year and UP Teaching awards — Drs Kate (K) May and Peter (PW) Smith.

The SARChI Chair, Prof Celia Abolnik, received the Kwame Nkrumah Regional Award for Women in 2016 during the African Union Kwame Nkrumah Scientific Awards ceremony held at the African Union headquarters in Addis Ababa on 24 January 2017, after being named one of Africa's top five female scientists.

In 2018, Prof Geoffrey Fosgate received the Willie Ungerer Memorial Award from the Southern African Society for Veterinary Epidemiology and Preventive Medicine for his outstanding contribution to veterinary epidemiology in southern Africa.



The research areas of the Department were focused on:

- The epidemiology of transboundary animal diseases such as Foot-and-Mouth Disease and Rift Valley Fever
- An initiative on plant-derived vaccine development using the latest technology for Avian Influenza and Newcastle diseases in poultry
- The effect and complications of various immobilisation products used in the wildlife industry
- Forensics related to combating rhino poaching
- Reproduction aspects of livestock animals and the influence of nutrition on their reproductive ability
- The proactive udder health management and monitoring of antibiotic resistance in dairy herds in South Africa
- An investigation into the use of oral rabies baits to vaccinate jackals as part of an initiative to reduce rabies outbreaks.

### Curriculum change

There were several curriculum changes, which included, at undergraduate levels, the following:

- The Veterinary Ethology (VET213) module in the second year was changed to Animal Production Systems (VAP200) and the module offered within the Faculty of Veterinary Science.
- The Veterinary Epidemiology (EPL420) module moved from fifth year to fourth year.
- There was a review of two fifth-year modules, Bovine Health and Production (BHP510) and Small Stock Health and Production (SSH510), which led to the two modules being replaced by Ruminant Medicine and Surgery (RUM510) and Ruminant Production Medicine and Herd Health (RUM511) modules.

Interactive and multi-disciplinary projects were introduced, such as the Feedlot and Artificial Insemination challenges for

the fifth-year students, and Veterinary Core Practice (VCP) and Veterinary Elective Practice (VEP) modules to meet 'Day One' skills, as developed by the regulatory body.

The review of the postgraduate curriculum led to the following:

- Two MMedVet degrees in Bovines — Bovine Herd Health, and Bovine Medicine and Surgery — were combined in 2014 into one MMedVet programme, namely Bovine Health and Production.
- The establishment of the MSc programme in Wildlife (MSc in Wildlife Health, Ecology and Management), in collaboration with academics from the Faculty of Natural and Agricultural Sciences (NAS) and the Mammal Research Institute (MRI).
- The introduction of the MSc coursework programme in Veterinary Epidemiology which created interest and led to recruitment of postgraduate students, particularly on the African continent.

## 4. Paraclinical Sciences

The Department of Paraclinical Sciences comprises four sections representing the primary disciplines of Pathology, Veterinary Public Health, Pharmacology and Toxicology. The Phytomedicine Programme is also hosted in the Department. While each individual section is responsible for the maintenance and development of their respective disciplines, they function as a unit in pursuing the departmental mission.

Prof Christo (CJ) Botha was re-appointed as Head of the Department, in 2011 and 2016. With the retirement of Prof Cheryl (CME) McCrindle at the end of 2011, Dr Fortune (FM) Sithole took over as Section Head: Veterinary Public Health (VPH) and when he resigned, Dr Musafiri (M) Karama became Section Head. Following the retirement of Prof Leon (L) Prozesky in 2016, Prof Neil (NM) Duncan was requested to head the Pathology Section. A senior academic post was created to stabilise the highly successful phytomedicine and ethnoveterinary medicine research programme in the Department. In 2015, Prof Lyndy (LJ) McGaw was appointed as Associate Professor, succeeding Prof Kobus (JN) Eloff as leader of the Phytomedicine Programme.

### Research

The Department was viewed within the Faculty as a research-intensive department, based on its research output. One of

the main objectives during this period was to promote and stimulate research, thereby increasing the research output of the Department to maintain its position. Although the Department comprises a diverse group of disciplines, one of the major overarching research themes involves indigenous wildlife, as it is considered a particular niche area of research in South Africa. Research projects focus on a variety of species such as vultures, crocodiles, pangolins, rhinoceroses, aardvark, cheetahs and sable antelope.

As aquaculture was becoming one of the fastest growing farming enterprises in southern Africa, fish health was considered important from an intensive farming viewpoint. The Department identified aquaculture as an important aspect where it has specialised in the pathology of fish diseases, specifically those of tilapia. In the latter part of the review period, members of the Department became more involved in aspects of antimicrobial resistance.

In the Pathology Section, the use of immunohistochemistry has received much attention and major projects on the tissue and cell tropism of African horse sickness virus and Rift Valley fever virus have been completed. The Phytomedicine Programme was going from strength to strength and contributed significantly to the research output of the Department. In this programme, increasing focus has been placed on scientific documentation and validation of traditional ethnoveterinary medicine, as well as translational aspects of bioactive plant-based preparations for use in animal health.

During the period under review, there was an increasing trend in publication output with the Department contributing considerably to the overall research output of the Faculty. Profs Leith (LCR) Meyer and Adrian (ASW) Tordiffe were recipients of the prestigious Research Award of the South African Veterinary Association (SAVA), in 2016 and 2018 respectively. In 2015, Prof Eloff received the MT Steyn prize from the *SA Akademie vir Wetenskap en Kuns*. In 2017, Profs Eloff and McGaw were listed in the top 1% of the University's authors according to Incites citations.

In 2018, Profs Meyer and McGaw were appointed as research coordinators and theme leaders, respectively of the 'African Wildlife Health and Management' and 'Translational Medicine' Faculty research themes.

### Restructuring and change

In 2016, funds were allocated to move the Phytomedicine Laboratory out of the Old Faculty Building, and to renovate

and extend the facility in the Paraclinical Building. The Laboratory is now under one roof within the Department, which improved its functioning and made it easier to supervise postgraduate students. In addition, the old seminar room of the Veterinary Public Health (VPH) Section was converted into a functional laboratory.

Recurriculation of the veterinary programme in 2014 allowed for two diagnostic pathology modules to be separated from the integrated species modules and epidemiology was removed from Veterinary Public Health.

The Food Safety Agency was appointed in 2012 as an external service provider to assist with the practical abattoir training of final year students during their rotation in Applied Meat Safety. The lecturers in the Department have embraced the hybrid teaching model. During the period covered in this report, Prof Meyer and Drs Sarah (SJ) Clift and Johan (JCA) Steyl all received the Lecturer of the Year award which is adjudicated by the student body. Furthermore, the Diagnostic Pathology module was voted as the best module presented in 2018.

During the review period, 39 master's and 42 doctoral students graduated. In 2015, the first student graduated after completing the course-based MSc in Veterinary Industrial Pharmacology. The Department also provided specialist training to a further 11 veterinarians in the MMedVet degree structure, which is endorsed by the South African Veterinary Council (SAVC).

The Department's Pathology Section has rendered an outstanding diagnostic service to various clients, including the wildlife and livestock industries. The Section has a huge diagnostic workload in order to generate the necessary material for under- and postgraduate student training. The pathologists have risen to the challenge in an exemplary manner, as more and more necropsies need to be conducted to supply sufficient training material for increasing student numbers.

## 5. Veterinary Tropical Diseases

The Department of Veterinary Tropical Diseases (DVTD) was established in March 1993 when the departments of Infectious Diseases and Parasitology were combined. It is a research-intensive department and has established itself as a leader in numerous areas, particularly those related to teaching and research in veterinary tropical animal health.

It has successfully established collaboration with both local and international institutions and has experienced significant growth in the numbers of staff members, postgraduate students and research outputs.

Since May 2009, the World Animal Health Organisation (OIE) has recognised the DVTD and its consortium partners as a Collaborating Centre for Training in Integrated Livestock and Wildlife Health and Management. This is the first Centre of its kind in Africa.

In the review period, the Heads of Department were Prof Koos (JAW) Coetzer (1994–2011), who was succeeded by Prof Darrell (DA) Abernethy (2012–2014), followed by Prof Tshepo (PT) Matjila who was appointed in August 2015 as the new Head of Department.

In 2018, the Department had a staff complement of 43, including 14 academics, whose research interests cover a wide range of tropical animal diseases and One Health issues. There were nine laboratories, which include virology, molecular biology, serology, bacteriology, parasitology and student training laboratories. SANAS-accredited test methods had typically been used in the bacteriology, serology, virology and helminthology diagnostic laboratories.

### Teaching and research

The Department is presenting and coordinating the course in Veterinary Parasitology and Microbiology in the fourth year of the BVSc programme and the microbiology and parasitology modules presented to the veterinary nurses. The departmental staff also lecture in the courses coordinated by other departments, for example, Bovine Health and Production, and Small Stock Health and Production in the BVSc programme.

The three postgraduate programmes were the collaboratively taught MSc (Tropical Animal Health) programme which is offered mainly online; a research MSc (Veterinary Science); and a PhD programme.

The MSc (Tropical Animal Health) was the only collaborative degree on offer in the Faculty at the time, and was presented jointly with the Department of Biomedical Sciences, Institute of Tropical Medicine (ITM), Antwerp (Belgium). The overall objective of the programme has been to follow an integrated One Health approach which links animal and human health.



The Department aligned its research programmes with the focal areas of the Faculty. The research output of the Department was also maintained through strategic alliances and collaboration with other institutions, mainly the Agricultural Research Council (ARC); Onderstepoort Veterinary Institute; the Institute of Tropical Medicine, Antwerp (Belgium); the Department of Infectious Diseases and Immunology, Faculty of Veterinary Medicine, Utrecht University (the Netherlands); and the School of Veterinary Medicine, University of California-Davis (US).

### Relevance and engagement

The Department recognised the need to share its educational knowledge, resources and research findings with veterinary and para-veterinary professionals, students and other stakeholders, and to provide high quality continuing professional development (CPD) training opportunities. A unique platform is the online African Veterinary Information Portal (AfriVIP), launched in February 2014 under an open licensing framework, to fulfil this need. The DVTD partnered with the Institute of Tropical Medicine, Antwerp (Belgium), AfriVet, Open Educational Resources (OER) Africa, and the World Organisation for Animal Health (OIE) Collaborating Centre for Training in Integrated Livestock and Wildlife Health and Management in developing this portal.

The Department has also offered a comprehensive list of short courses, with courses ranging from laboratory skills to animal health training.

In support of the community engagement (CEn) programme of the Faculty, the Department continued to run a number of CPD courses for veterinarians and animal health officers, as well as community outreach research projects and diagnostic services to a wide range of clients. The most prominent of the departmental programmes is the Mnsi Community Programme (MCP), based in the Mpumalanga province adjacent to the Kruger National Park. It is a multidisciplinary research and development programme driven within the context of the One Health approach, which provides an international platform for integrated teaching, learning, research and community engagement at the livestock-human-wildlife interface.

The Department also offers diagnostic services to the Veterinary Academic Hospital (OVAH) and other departments in the Faculty. These services are in most instances linked to the training of students. Specialised diagnostic services are rendered to external clients and industries on request, among others, the thoroughbred and poultry industries, provided that all expenses including personnel are paid for and it is financially beneficial to the Department.



## 10 | Gordon Institute of Business Science

### DEANS' OVERVIEW

For the University of Pretoria's Gordon Institute of Business Science (GIBS), the period between 2009 and 2018 was a time of maturation, strengthening international credentials and building strong African and global partnerships. This period also marked a change in leadership when the founding Director, Prof Nick (N) Binedell, stepped down in 2014 from the role of Dean, a new position to which he was appointed in December 2011. He was succeeded by Prof Nicola (N) Kleyn in April 2015.

Prof Binedell played a central role in the establishment of GIBS. Since 1998, when he and the Vice-Chancellor of UP, Prof Johan (J) van Zyl, first agreed on a blueprint for the new institution, Prof Binedell proved a pivotal and entrepreneurial leader whose personality had become deeply entwined with the visibility and image of GIBS.

Over the period 2009 to 2015, Prof Binedell maintained the momentum that steered GIBS during the business school's formative years. Under his watch, many notable achievements were recorded, including the launch of a full-time Entrepreneurial MBA in 2010. In the same year, Prof Binedell worked closely with UP Vice-Chancellor Prof Cheryl de la Rey in the development of the University's long-term strategy, UP 2025, and the consultations and dialogue that were pursued.

In 2011, Prof Binedell was awarded the PMR.Africa Diamond Arrow Award for an Individual in the Business School fraternity in South Africa. The same year, GIBS debuted on the *Financial Times* Executive MBA Ranking in 67th place globally and first in Africa.

Prof Kleyn, who joined GIBS in 2000 and taught on the inaugural Master's in Business Administration (MBA) programme, was appointed Deputy Dean in November 2013. Previously she held the position of Executive Director: Academic Programmes and was an associate professor in Marketing at GIBS. Prof Kleyn was ideally placed to take the strategic leadership role when, in August 2014, Prof Binedell announced his intention to step down as Dean. In January 2015, it was announced that Prof Kleyn would take over as Dean for a five-year period from 1 April 2015 until 2020.



Prof Nick Binedell | Dean: 1998-2014

Having fulfilled the shared ambition of UP and GIBS to provide business education that was relevant to South African business, and business leadership locally, on the African continent as well as globally, the remainder of Prof Binedell's term as Dean was marked by an expansion of the student body, the campus and the academic staff. The deepening of client relationships remained a key focus, as did the attention paid to developing GIBS' executive education offering and the continuous development and improvement of the flagship MBA. This was a trend that continued under Prof Kleyn's leadership, who further embedded the focus on research.

From 2015 the building of a robust research ethos, with particular attention given to forging regional and international relationships with both individuals and institutions, took centre stage. The process was guided by the Director of Research, Prof Helena (H) Barnard, who ensured that GIBS' research endeavour remained in line with the research themes of entrepreneurship, management in the African context, and business and society.

As a result, there was a stronger focus on the publication of journal articles and case studies for the scholarly community and presentations at symposia, as well as contributions to white papers. Between 2009 and 2018, GIBS produced 212 articles in accredited journals, 16 white papers, and 75 published case studies. Of its 33 full-time academic staff, seven were NRF-rated researchers: Prof Barnard (B3), Dr Kerry (K) Chipp (C3), Prof Alet (AC) Erasmus (C2), Prof Kleyn (C1), Prof Marianne (M) Matthee (Y2), and Prof Daniel (DJ) Petzer, and Prof Michael (M) Ward.

### Affiliations and excellence

In the review period, GIBS continued to entrench its credentials as an African business school of global standing. The following were some of the outstanding highlights:

- In 2012, the GIBS DBA, developed in 2004, became the first South African doctoral programme in business to receive international accreditation from the Association of MBAs (AMBA).
- In addition to its membership of AMBA (from 2012) and the Association to Advance Collegiate Schools of Business (from 2017), GIBS was affiliated with the South African Business Schools Association (SABSA) and the European Academy of Business in Society (from 2010) and became a signatory to the Principles for Responsible Management Education (PRME) in 2011.
- In 2016, GIBS received accreditation from the Association to Advance Collegiate Schools of Business (AACSB) and became a member of the Central and East European Management Development Association (CEEMAN).

In a continuation of excellence, in October 2018, the GIBS MBA was ranked among the top 100 business schools globally in the UK's *Financial Times MBA Ranking* survey, the only business school in Africa to appear in the ranking at the time. Earlier in the same year, in May 2018, GIBS was ranked among the 50 best business schools for executive education by the *Financial Times*. This marked the 15th successive year in which GIBS had been ranked in this annual assessment,



Prof Nicola Kleyn | Dean: 2015-2018 and beyond

which covered both customised programmes tailor-made for corporate customers and open programmes designed for leadership within organisations.

From a teaching perspective, GIBS remained committed to its mission to 'significantly improve the responsible individual and organisational performance through the provision of high-quality business and management education'.<sup>1</sup> This ethos was embedded across the business school's mixture of academic and executive programmes aimed at senior executives and focused on general management.

Over the period 2009 to 2018, GIBS continued developing its executive education offering and forged firm partnerships with leading South African private sector firms and state-owned enterprises. During that period, GIBS' portfolio of corporate partners grew significantly — the school had engaged with 20 231 and 38 175 delegates on Open Programmes and Custom Programmes respectively.

Across the business school's educational offerings, from academic programmes to executive education, the teaching

and learning methodologies adopted encompassed action learning, case-based learning and experiential learning processes. And, from 2012, the school increasingly began to take on a blended learning approach which was enabled by the update of digital platforms and technologies. In addition, the launch of GIBSdirect, the business school's new online learning portal, saw the start of marketing and financial management modules.

### Governance structure

GIBS is wholly owned by UP and governed for administration and strategic purposes by a board appointed by the University. However, when GIBS was formed, it was agreed that autonomy would be an important requirement of its success. The main areas of operation at GIBS included academic programmes, executive and certificate programmes,

company-specific programmes, policy, leadership and gender studies, marketing, and finance and administration. Senior permanent members of GIBS staff, who reported directly to the Director (and since 2011, the Dean), managed each of these areas of activity. The heads of these units made up the Executive Committee, which met on a monthly basis.

Over the period, GIBS continued to report back to the University Senate through a Committee of Senate, which had been established in 2006.

GIBS' full-time academic staff component grew to 56 permanent academic staff in 2018. As the academic and administrative staff members of the business school expanded, much care was taken to ensure that staff members were oriented to the school's mission, as well as its values and practices in relation to all the programmes, including the flagship MBA programme.

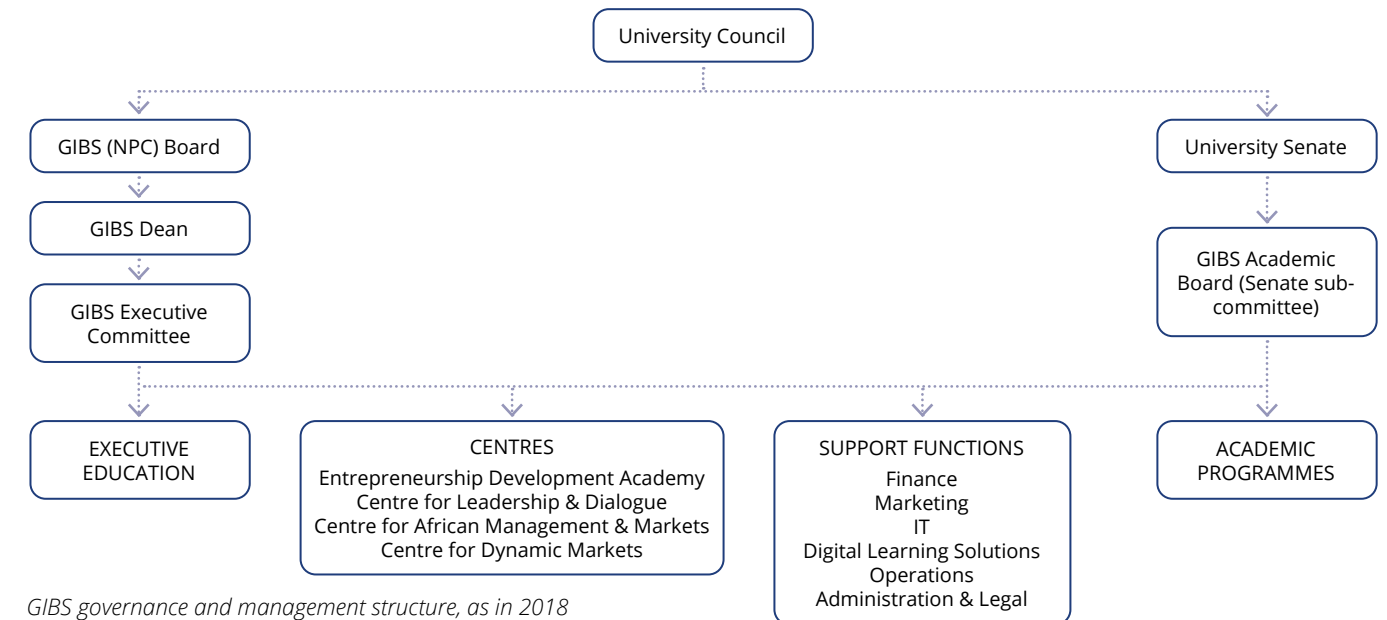

GIBS governance and management structure, as in 2018

### Facilities and resources

The North Block of the GIBS Illovo campus was completed in March 2008, adding a wide range of facilities, including a 160-seater auditorium, a restaurant and a fully equipped Illovo Lodge.

The next phase of construction began in 2012, when plans got underway for a building project to expand the Illovo Lodge (which was renamed Illovo Hotel), construct a roof deck and build new classrooms, in addition to refurbishing the original catering kitchen.

<sup>1</sup> <https://www.gibs.co.za/about-us/pages/default.aspx>



At the conclusion of the 2012 building project and consequent expansion of the Illovo Hotel, GIBS increased usage of the facility, offering an array of conferencing and meeting facilities, accommodation to both business and leisure travellers, as well as providing an exclusive and quiet location for large groups, the hosting of business conferences, training sessions and meetings of up to 180 people.

By 2018, the campus's new conferencing offering included a 180-seater auditorium, 11 tiered and flat-floor classrooms, numerous syndicate and break-away rooms, in-house catering services, a restaurant and deli, and campus-wide WiFi.

In 2017 this offering was further enhanced by the completion of a collaborative working space called 'Co. Central', a unique space which allowed GIBS to host more curated sessions, workshops, product launches and even pop-up stores.

Co. Central continued the business school's focus on making the most of the dynamic and bustling campus which, each year, hosted a wide variety of high-level events such as forums and conferences, book launches, colloquiums, art exhibitions, alumni gatherings and other events. These events attracted leaders and pioneers in business, politics, civil society and academia to the Illovo Campus.

## **GIBS programmes and courses**

### **Academic programmes**

By 2018, enrolment in GIBS' academic programmes was about 5 643 across the DBA, MBA, MPhil, PGDip, PDBA and Certificate programmes, while corporate education (company-specific and executive education) attracted about 7 304 delegates.

As of 2018, GIBS offered the following academic programmes:

### **Doctoral programmes**

Two doctoral qualifications were offered, viz. Doctor of Business Administration (DBA) and Doctor of Philosophy (PhD).

### **Master of Business Administration (MBA)**

GIBS' flagship programme remained its MBA. The method of delivery and teaching was modular, classroom-based and highly interactive, with extensive use of relevant case studies, work-related projects and syndicate work, which compels effective team interaction and much practical learning.

In 2018, GIBS and Japanese car manufacturer Toyota launched Africa's first specialist Manufacturing MBA to boost the country's manufacturing sector, with the first intake planned for 2019.

### **Master of Philosophy in International Business (MPhil IB)**

GIBS added a specialised MPhil IB degree to its academic programmes in 2018. The MPhil IB is an NQF Level 9 master's qualification that aims to equip participants with the global business strategy skills needed to understand the challenges and grasp the opportunities that the global business environment offers.

### **Postgraduate Diplomas**

GIBS offered three postgraduate diplomas during the review period:

The Postgraduate Diploma in General Management (PGDip GM) is a one-year qualification aimed at individuals seeking to gain a broad overview of business fundamentals in order to prepare themselves for the GIBS MBA journey.

The part-time Postgraduate Diploma in Business Administration (Part-time PDBA) is a year-long programme that aims to fast-track high-potential young graduates into the world of business. Covering the same fundamental business principles as the MBA, the part-time PDBA offers six credits towards the GIBS MBA, conditional on students attaining a 65% aggregate in these subjects and commencing the MBA within five years of completing the PDBA.

In 2018, GIBS added a full-time Postgraduate Diploma in Business Administration (Full-time PDBA) to its academic offering. The programme, delivered over 12 months,

focuses on experiential learning through business cases and experience.

### **Programme for Management Development (PMD)**

The GIBS foundation Programme for Management Development (PMD) is aimed at managers seeking to accelerate their careers. It is a year-long programme (running from February to November) that orientates newly appointed managers to the business environment and provides them with an understanding of the functions of management and skills essential at a management level.

### **Executive programmes**

GIBS offered a range of executive programmes and courses between 2009 and 2018, all of which were designed to focus on assisting organisations in developing individual leadership capabilities at a general management level down to specific functional areas. They included:

- Harvard Business School Programme
- General Management Programme
- Global Executive Development Programme
- Leading in a Digital Economy
- Leading Women
- Nexus Leadership Programme.

These programmes and courses covered a variety of subjects, from management innovation and executive decision-making to strategic human resource management and finance for non-financial managers.

During the period GIBS had partnerships with international business schools for student exchange, lecturer exchange, research collaboration, library or resource sharing, study tours and networking events. A number of memoranda of understanding and formal agreements gave effect to these strategic partnerships.

### **Custom courses and programmes**

In-house executive short courses, run in conjunction with a local business, continued to find favour with companies over the review period. In addition, GIBS offered in-house, company-specific programmes, which were designed to meet client needs. Its philosophy was to form a partnership with client companies and to work closely with them to determine the specific competencies that needed to be addressed.



Ethics and Governance Think Tank Forum: Justice Mogoeng Mogoeng

### GIBS alumni

The GIBS alumni community consists of all graduates since the establishment of the business school in 2000.

By 2018 the GIBS Alumni Office was engaging with over 5 700 alumni. The alumni are employed primarily in executive and senior management positions and entrepreneurship, across various business sectors.

During the review period, a number of notable achievements were recorded by members of the GIBS Alumni, including:

- In 2011, GIBS Entrepreneurship MBA alumnus, Tito Mbatha, was awarded the runner-up prize in the South African Breweries (SAB) Foundation Innovation Awards for his company, The Invoice Exchange.
- In 2013, GIBS MBA graduate Olebogeng Glad Dibetso (2011–2012) won the AMBA international MBA Student of the Year Award.
- In 2014, GIBS MBA graduate Tshifhiwa Gladys Ramuthaga (class of 2010) won the Institute of Information Technology Professionals South Africa's 2014 Visionary CIO Award.

- In 2016, the MBA class of 2015–2016 students Elicia Demont, Thomas Kgekolo, Jamal Sahib and Ewald Beukes of Team Brand SA took joint first place in the prestigious 2016 Zurich Enterprise Challenge.
- In 2018, the Association to Advance Collegiate Schools of Business, the world's largest business education network, named GIBS alumna Stacey Brewer among 29 business pioneers from 13 industry sectors at its 2018 Deans Conference in Las Vegas, United States. Brewer is CEO and co-founder of SPARK Schools, a network of affordable private primary schools dedicated to delivering accessible, internationally benchmarked and high-quality blended education.

### Forums and conferences

By 2018, GIBS was hosting around 40 forums per annum, attended by more than 4 000 delegates.

The GIBS Forums ranged from discussions on corporate strategy and performance culture to annual economic outlooks, scenario planning, technology, sports and branding. These speaker-led events spanned industries from mining to

technology, health, finance, manufacturing, advertising and retail, enabling attendees to stay abreast of developments in their sectors and other key local and global industries.

During the period under review, a number of global and South African experts addressed GIBS Forum gatherings, including:

- Finance Minister Pravin Gordhan, 2010. 'Restructuring the economy and crafting the way forward'.
- Deputy President Kgalema Motlanthe, 2011. 'GIBS Foresight 2011 Forum'.
- Japanese Ambassador Toshiro Ozawa, 2011. 'The Role of Japan and SA in promoting growth in Africa'.
- Al Gini, Professor of Business Ethics at Loyola University, 2012. 'Business ethics and good leadership'.
- Philippe Mellier, CEO: De Beers, 2012. 'Investing in Botswana'.
- Cynthia Carroll, CEO: Anglo American, 2012. 'Apartheid's impact on SA mining'.
- Prof Muhammad Yunus, Nobel Laureate and Founder of Grameen Bank, 2013. 'Starting Grameen Bank'.
- Public Protector Thuli Madonsela, 2014. 'Corruption'.
- Jeffrey Immelt, CEO: General Electric, 2015. 'CEO Engage'.
- Maria Ramos, CEO: Barclays Africa, 2016. 'Shared growth'.
- Deputy President Cyril Ramaphosa, 2017. 'Leadership Engage'.
- Sizwe Nxasana, founder Future Nations School and former CEO: FirstRand Group, 2018. 'An Africanised education system'.

### Conferences

In 2009 GIBS hosted in excess of 30 one-day conferences — events focused on topics relevant to business which provided an opportunity for business leaders to be exposed to the latest thinking on issues and network with peers. The numbers grew year on year, and in 2018 alone, the school held 26 conferences and masterclasses that involved 2 324 delegates.

Between 2009 and 2018, GIBS hosted several prestigious global conferences:

- In 2012, the 20th CEEMAN Annual Conference and Deans and Directors Meeting, which focused on the role of business schools in nations in transition.

- In 2013, the Academy of Management Africa (AFAM) Conference, which attracted delegates from around the world. This was the first time the Academy held a specialised conference outside North America.
- The 2017 European Foundation for Management Development (EFMD) Middle East and Africa Conference, a three-day event which attracted leading academics from business schools around Africa and the Middle East.
- In March 2017, a two-day International Conference on Responsible Leadership which focused on the importance of responsible leadership to ensure the longevity of both institutions and countries.

### Dialogue, research and engagement

During the review period the four GIBS centres of excellence acted as partners to guide problem-solving and find solutions for companies and leaders. These dynamic bodies facilitate research and engagement with thinkers and other businesses around the world on topics of common interest.

In addition, in 2009 the Centre for Business Analysis and Research was created to nurture collaboration and identify critical synergies among the various programmes and initiatives undertaken at GIBS. It is home to a variety of important programmes and initiatives, including the Asia Network, the Base of the Pyramid (BOP), the Transnet Programme for Sustainability, the Vodacom Information and Communication Technology Programme, as well as the African Business Network.

### African Business Network and Centre for African Management and Markets

Building on the work of the African Business Network, which was established in 2006, GIBS launched the Centre for African Management and Markets (CAMM) in September 2018. Led by Prof Adrian (AD) Saville, the intention was to drive research, innovation and thought-leadership across the continent. The Centre would focus on conducting research on the economies and management philosophies, processes, and practices of African countries and hosting networking events, including forums, masterclasses, seminars, and whitepaper sessions.

### Centre for Dynamic Markets

Established in 2014, the subscription-based Centre for Dynamic Markets (CDM) — under the leadership of Prof Lyal (L) White — focused on generating and sharing information about doing business in emerging markets to help better inform and prepare companies and leaders and improve



their general management practices markets. The CDM research reports include the Dynamic Market Index, released in both 2014 and 2016. The Index was designed empirically to identify the conditions and institutions that enable catalysts for growth, wealth creation, innovation and overall socio-economic development in the global economy.

### Centre for Leadership and Dialogue

Launched in the mid-2000s, the GIBS Centre for Leadership and Dialogue aims to equip leaders with the essential tools for achieving success in an increasingly complex world and with the capacity and insights to lead their businesses, public institutions and social enterprises into the future. Under the leadership of Dr Shireen (S) Chengadu, this was achieved by hosting open engagements, closed discussions run according to Chatham House Rules, thematic dialogues and seminars, and public forums designed to cover a broad range of topics impacting the future of South Africa and the world.

An entrepreneurship academy and a think tank were two further GIBS initiatives during the review period:

### Entrepreneurship Development Academy

Founded in 2014, the Entrepreneurship Development Academy (EDA) — headed by Yogavelli (Y) Nambiar — specialises in tailor-made, practical business education and support services delivered nationally by leading academics and industry specialists to entrepreneurs. The EDA's primary focus is to make business education accessible to start-up, micro and small business entrepreneurs, especially those who have been underserved or marginalised. In so doing, small business owners are helped to develop sustainable, efficient enterprises that can employ more people.

In 2015, the EDA received the Most Innovative Training Programme award from the South African Women in Construction initiative for its National Builders Registration Council — GIBS Women Empowerment Programme.

### The Ethics and Governance Think Tank

Established in 2016, the Ethics and Governance Think Tank was founded by Rabbi Gideon Pogrand as a platform from which to explore and influence South African business to

follow a more ethical approach and build a more sustainable future. In 2018 the Think Tank was selected as one of the AACSB's 'Innovations that Inspire', a US initiative that provides global recognition of the innovative ways that business schools are identifying and creating opportunities to nurture, support and connect others across the leadership development ecosystem.

### GIBS initiatives

- *Acumen* magazine. In 2012, GIBS launched its quarterly magazine, *Acumen*, under the editorship of veteran journalist Chris Gibbons. The intention behind the publication is to assist in the debate, sharpen the saw, engage, provoke, and have dialogue about issues affecting business and society. In 2018, *Acumen* magazine received gold at the Trade Association of Business Publications International Tabbie Awards. The awards attracted a pool of 400 nominations from around the world.
- Spirit of Youth. Launched in 2005, the programme enabled Grade 11 and 12 learners to engage critically with relevant issues that affect the country and their communities. The selection of learners is based on academic excellence, demonstrable leadership qualities and commitment to their communities. The year-long programme caters for rural, urban, township and independent schools.
- Nexus Leadership Programme. Nexus is a programme based on experiential learning, reflective practice and direct engagement. For eight months, delegates meet for approximately two days per month and, through a series of written assignments, integrate the learnings from the carefully designed engagements into their own lives. The programme was selected in 2017 by AACSB as one of 35 programmes globally that demonstrated 'the unique ways that business schools globally embrace an innovative mindset, and serve as visionaries across the higher education landscape'.
- Goldman Sachs-GIBS 10 000 Women. Launched in 2008, the Goldman Sachs-GIBS 10 000 Women Programme provided 10 000 women from across 43 countries with

business and management education, mentoring and opportunities to network. The three-year initiative was founded on research conducted by Goldman Sachs and others which suggested that investing in women is one of the most effective ways to reduce inequality and facilitate inclusive economic growth. GIBS managed the programme in South Africa and provided close on 350 female entrepreneurs with business and management training. The programme concluded in 2014.

- GIBS corporate social responsibility. Since 2004 GIBS has elected to support disadvantaged communities and those in need of support and empowerment through a series of corporate social investment (CSI) initiatives. In line with the academic nature of the institution, the education space was a particular focus of attention. During the period under review, GIBS and staff complement supported many initiatives, including:
  - Give As You Earn Programme
  - The Beatrice Xalisa Bursary Fund
  - Gordon Primary School Feeding Scheme
  - Educator Development Programme with Ekukhanyisweni Primary and Emfundisweni Primary.

The period 2009 to 2018 underlined the maturation of the GIBS brand and academic offering. Furthermore, as GIBS marked the completion of its first 18 successful years in 2018, it was with the realisation that a strong and stable leadership team was in place, alongside world-class academic staff. The home-grown African institution was well placed to hold its own in a competitive global landscape as a reputable, innovative and relevant international business school. And yet, in a changing global landscape, it was also clear that change and transformation would remain a central part of the GIBS story as it concluded its second decade.

**Prof Nick Binedell** | Dean, 1998-2014

**Prof Nicola Kleyn** | Dean, 2015-2018 and beyond

Ethics and Governance Think Tank Forum: White Collar Crime



## GIBS: PERFORMANCE AT A GLANCE

### Enrolment and diversity

#### Student profile

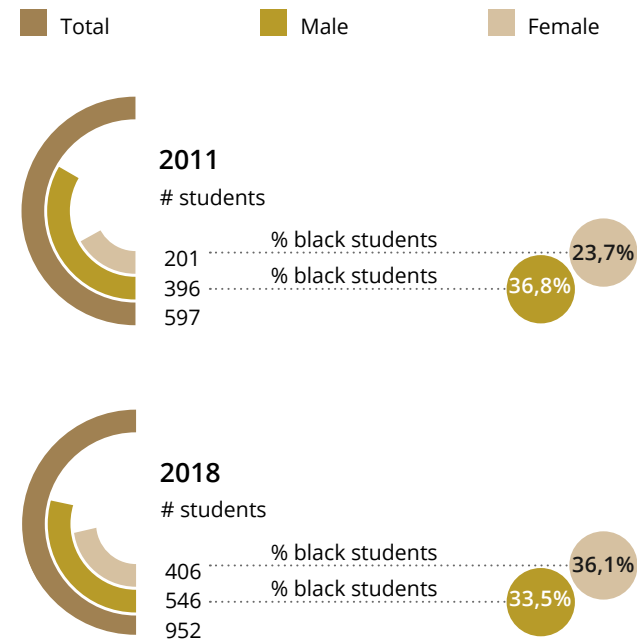

#### 2018 UK Financial Times Ranking

##### Top 100

MBA's globally  
Only one in Africa

##### PhD graduates



##### Top 50

Executives programme  
15th success year

##### Research output units



### Success

#### M enrolment and graduates

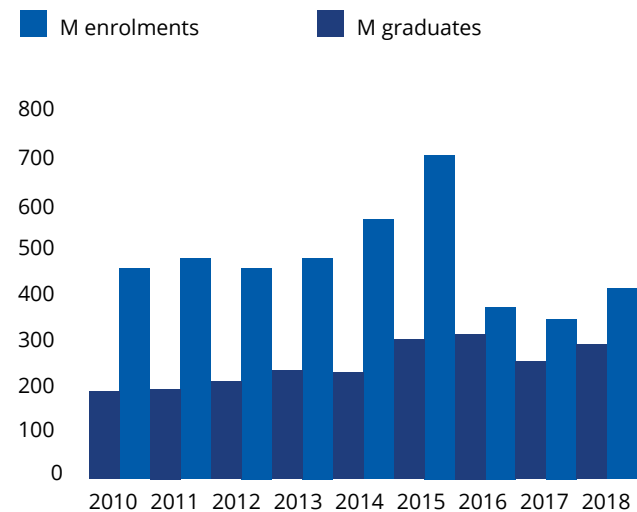

#### Research capacity

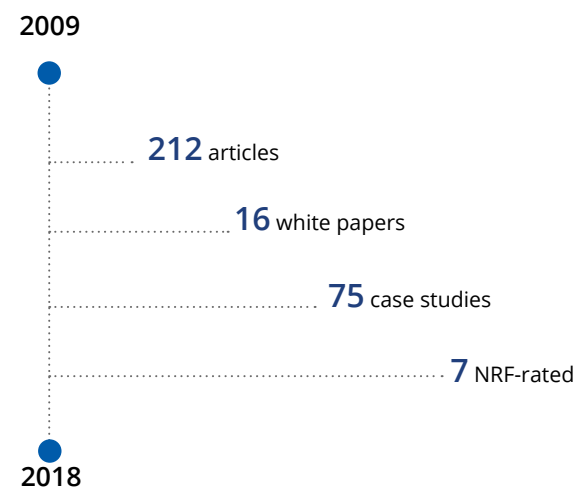

## 11 | Mamelodi Campus

### OVERVIEW

The Council of the University of Pretoria designated the Mamelodi Campus a 'community-engagement hub' in 2007, following the incorporation into UP of the former Vista University campus, located in the Mamelodi township.<sup>1</sup> Since then, the Mamelodi Campus has been known for its involvement in a range of community engagement activities that focus primarily on the provision of educational opportunities for the children and youth of the township. However, the mandate of the campus has reached far beyond what is typically regarded as community engagement, with the adoption of a holistic approach that focuses on addressing the cycle of poverty and violence that the youth in socially and economically deprived communities often experience.

Two years later, in 2009, Prof Cheryl (CM) de la Rey was appointed as Vice-Chancellor and Principal of the University of Pretoria. During her tenure, the foundation programmes offered to entry-level university students became the flagship project of this campus.

In 2015, in an effort to sharpen the strategic focus of the campus and to ensure its contribution to the academic project of the University, Prof De la Rey initiated an institutional review of the campus in relation to the University's strategic vision and mission. Following the review, in 2016, the University appointed a Dean for the campus, Prof Nthabiseng (NA) Ogude. The brief of the Dean was to develop a new academic vision and mission for the campus, with the foundation programmes forming the nucleus of such a vision and mission. The appointment of the Dean was preceded by the academic leadership of the campus by Edwin (ET) Smith, the Campus Manager for the period 2004 to 2016.

Prof Nthabiseng Ogude | 2016-2018 and beyond



### An anchor strategy

The review process culminated in the development of an anchor strategy for the campus, the *Mamelodi Collaborative*, comprising five niche areas, namely:

- Broadening educational pathways to tertiary attainment with a focus on science, technology, engineering and mathematics (STEM) fields, which comprised two arms — the foundation programmes and the Pre-University Academy (PUA)
- Science and the urban environment
- Leveraging the arts and culture

<sup>1</sup> Deputy Minister of Education. 2002. Education Ministry outlines plans for University Mergers. Leader, August 2002: 6. See also Government Gazette No.25737. Incorporation of the Mamelodi Campus of Vista University with the University of Pretoria, 14 November 2003.



- Strong and healthy neighbourhoods
- Economic development and entrepreneurship.

The *Mamelodi Collaborative* was a partnership between Rutgers University-Newark (US) and the University of Pretoria, which came into effect in 2017. It was anticipated that the collaborative would, over time, result in a strategy for faculty, staff and student exchanges, research collaborations, cooperative course development, and the use of data analytics towards the effective monitoring and planning of the work undertaken by the two anchor institutions in Pretoria's Mamelodi Township and in Newark, US.

The collaboration aims to reduce the cycle of poverty and violence that the youth in socially and economically deprived communities often experience. This has entailed a two-pronged approach:

Firstly, the focus was on projects that foster the provision of educational opportunities for under-privileged students to study programmes in STEM fields through sustainable partnerships between high schools, the universities, business and international partners. Students are nurtured from early high school through academic enrichment in after-school programmes, on Saturdays and in Winter and Summer Schools. This Pre-University intervention identifies talented students, addresses the problem of under-preparedness and the challenges of the transition from school to university, such as conceptual gaps, high attrition, poor progression and low completion rates, particularly of undergraduate students. It was envisaged that a system that tracks the performance of students from the time they enter the Pre-University Programme through to graduation would be implemented. The project would also include in-service professional teacher development programmes.

### Notable achievements

The following presents a summary of outcomes and achievement:

### Foundation programmes

In 2008, the University introduced four foundation programmes on the Mamelodi Campus, namely programmes leading to bachelor's degrees in Biological and Agricultural Sciences, Physical Sciences, Mathematical Sciences, and in Economic and Management Sciences. Introduced with the

<sup>2</sup> See also [Performance at a Glance](#), page 409

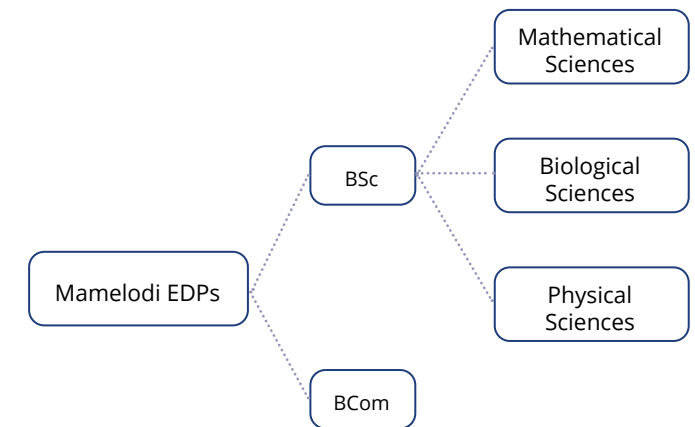

*Mamelodi Extended Degree Programmes*

support of the Department of Higher Education and Training (DHET), the focus was on addressing the under-preparedness of incoming students for mainstream degree programmes. These foundation programmes were refined to become two extended degree programmes (EDPs), as illustrated in the diagram above.

Since their introduction, the programmes have contributed to widening access for students in STEM fields, and in Economic and Management Sciences. The student population grew by over 200% from the initial 300 in 2008 to 850 in 2018, which comprises approximately 10% of the total first-year intake at UP. The overall module pass rate during this period has also been consistently high, averaging 83%, in line with the benchmark set by the Department of Higher Education and Training (DHET) of 82%.<sup>2</sup>

While foundation programmes widened access over these years, they have only been moderately successful in promoting access with success. Cohort studies conducted between 2014 and 2016 showed that around 15% of students who commenced their studies in these programmes completed their studies in the minimum time while the eventual completion rate of students completing their degrees was expected to be in the order of 50%. However, two outcomes over this period were decidedly positive: of those still enrolled in their fourth year, a high percentage of students remained in science-related programmes (79%); and more than half had enrolled for postgraduate programmes in 2012, which is a criterion for success that is especially important for a research-intensive university.

### The Pre-University Programme

In light of the growth in the number of students enrolled in foundation programmes, it was necessary, and seemed viable, to strengthen the programmes from an institutional perspective. However, it also meant that it was important to understand the degree to which greater numbers of learners from the Mamelodi area could gain access to these programmes, and to mainstream programmes at UP. In this respect, the following observations:

Firstly, the number of learners who were applying to UP from the Mamelodi schools saw a steady upward trend between 2014 and 2017, at 346, 336, 346 and 362, respectively. It is illustrative to put these numbers in perspective; for example, of the 496 Grade 12 learners from the 20 Mamelodi schools, 31% obtained university entrance in 2017. Thus, the number of students who applied in 2017 constituted 73% of the bachelor's passes obtained by the twenty schools in Mamelodi.

Secondly, unlike the application rate, the realisation rate (i.e., the proportion of students who apply and are admitted to the University, including to the foundation programmes), has been steady over the years, averaging at about 70%. This may not be as high as might have been desired, as the admission point scores (APS) of some of the learners do not meet the UP criteria for admission.

### Performance at a glance

In addition to the data presented above, the following are illustrative of success achieved:

In the period of 2013 to 2018, assistance in Mathematics and Physical Sciences was provided to an average of 800 Grade 10 learners, 440 Grade 11 learners, and 320 Grade 12 learners. In total, 44 pre-service teachers served as tutors and, in the process, consolidated their own Physical Science and Mathematics understanding and developed familiarity with the national prescribed curriculum for Grades 10 to 12. This exposure further ensured effective lesson planning and opportunities to develop best practices in addressing learners' struggles with these 'gateway' subjects. They were also exposed to the diversity of the school-going community and bettered their classroom management, which significantly reduced the learning curve associated with beginner teachers taking up positions in schools.

Learners, selected on merit, from the 20 schools attended STEM enrichment programmes in which an e-learning platform was used to supplement the traditional 'chalk and talk' teaching typically provided in schools and by NGOs working in the education space in Mamelodi. Although the Mamelodi Mathematics and Science programme had a limited footprint, it had notable qualitative and quantitative achievements. A comparative evaluation of the Mathematics and Physical Science marks of the 2018 Grade 12 cohort showed that the learners enrolled in the after-school programmes (ASPs) performed above the national average:

- In Mathematics, 48% received symbols higher than a level four (50–59%), while 22% attained over 70% (level 6–7). Nationally, only 10% of learners obtained more than 50% in Mathematics.
- In Physical Science, 53% of the ASP learners obtained over 50%, and 29% over 80%, compared to the national performance where 12,5% of learners obtained over 50% and 14% over 80%.
- One ASP learner achieved an exceptional 98% in Mathematics and 100% in Physical Science.
- In 2014, an average of 20% of the Grade 12 learners in the programme registered at the UP. In the following year, this number almost doubled to 33%. This trend continued, with 44% of the 2016 cohort qualifying to enrol at UP.
- The grade distribution in Mathematics and Physical Science for the Mamelodi cohorts of 2016, 2017 and 2018 further validated the improvements that were brought about by partnering with various role-players to achieve a more holistic approach.<sup>3</sup>

Towards the end of 2018, Grade 12 learners completed a survey which showed that 79 of the 121 participants (or 65%) had received provisional acceptance from a university. While it is difficult or near impossible to obtain accurate figures for actual registrations of all learners following the completion of secondary school, the Mamelodi Pre-University Programme obtained the figures for those who registered at the University of Pretoria, of whom approximately 20% enrolled in the following programmes: Financial Services, Engineering and the Built Environment, Medical Sciences and the formative Bachelor of Science degree.

<sup>3</sup> Bureau for Institutional Research and Planning, 2017.



## MAMELODI: PERFORMANCE AT A GLANCE

### Student enrolment and gender

#### EBIT

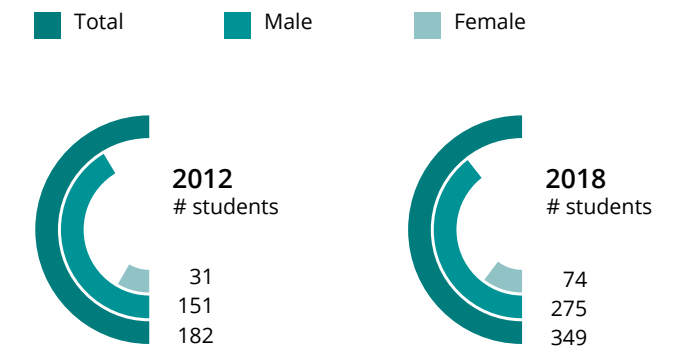

#### EMS

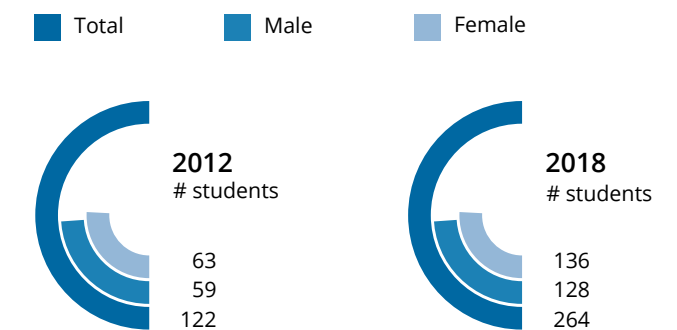

#### NAS

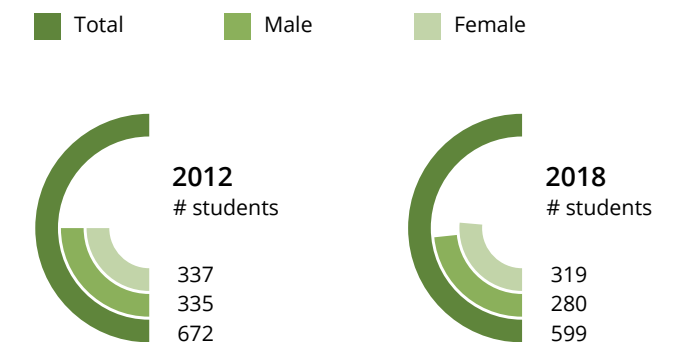

**Diversity and success**

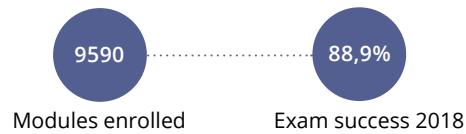

**Foundation programme enrolment**

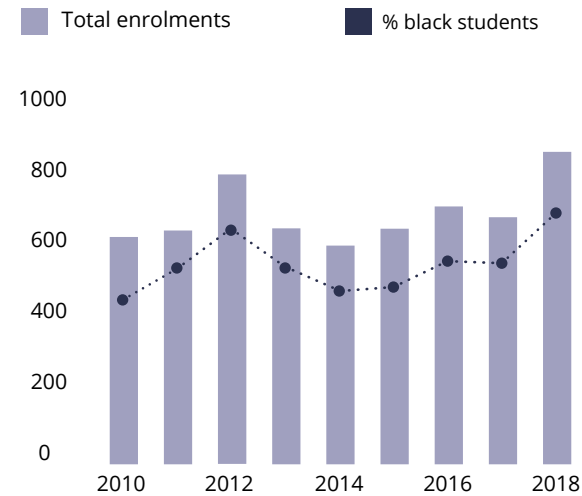

**Module pass %**

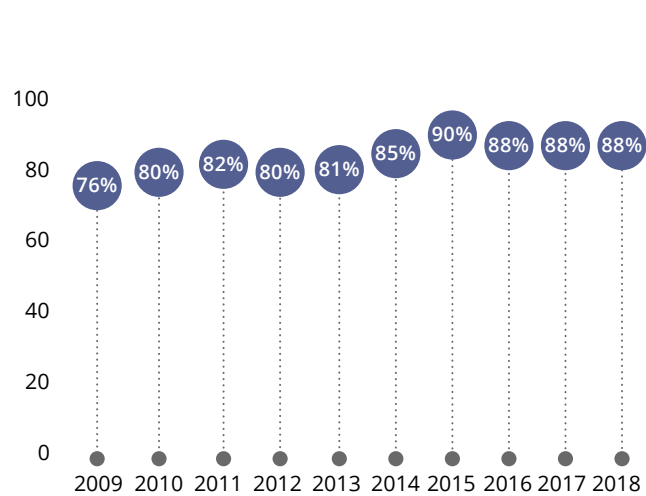

**Module success rate**

**Foundation programme**

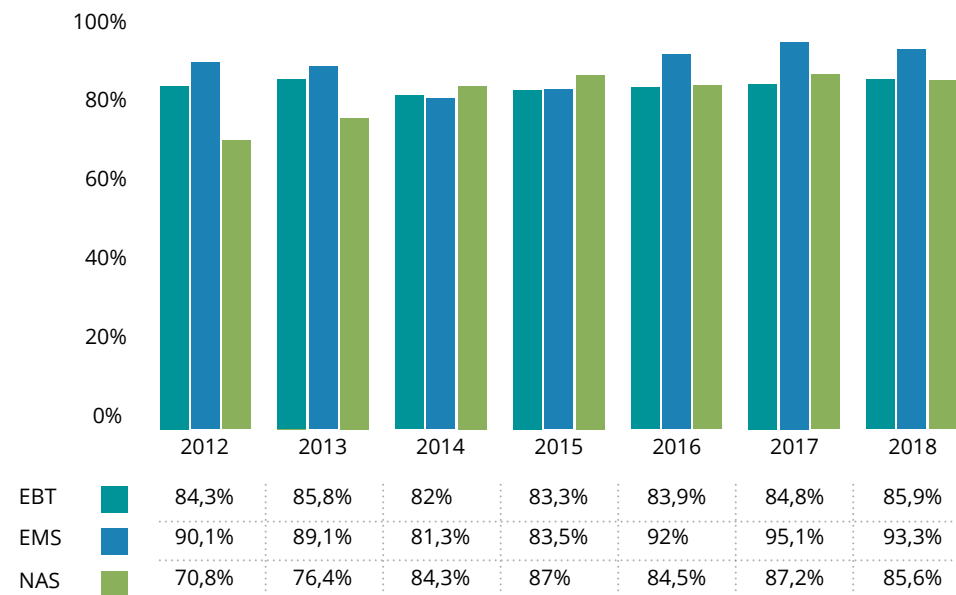

**Emergence of the Pre-University Academy**

Following several improvements between 2013 and 2018, the after-school programmes offered on the Mamelodi Campus included the extended degree programmes offered by the University itself, as well as external partners working in the Mamelodi educational ecosystem. In 2018, the campus launched the Mamelodi Pre-University Academy (PUA), which houses all the pre-university programmes hosted by itself and other partners on the campus premises. Through the PUA, the campus was now able to follow a multi-stakeholder approach to extend its reach from the initial 500 beneficiaries to 30 000 youth in Mamelodi.

Extracts from the qualitative data provide a sense of learners' views as to the benefits of the after-school programmes. Three comments illustrate aspiration for further studies, parental support and motivation:

*"My Dad even when he was chilling told everyone at home I was attending the University of Pretoria though I was in Grade 10. I had no chance of failing. He would look at my marks and say how will he tell people I had a bad mark. You cannot afford to get a mark lower than 80%."*

*"My Mom never went to University so she wanted one of us to go there."*

*"I came for friends, food, education, and that feeling of being at University."*

Further comments are linked to the perceived academic benefits of the after-school programme:

*"I think when you come here (ASP) and you are behind at school; you learn. By the time they do the work at school you already know the topic."*

*"I met other top learners from other schools, we share information and past papers, we formed a network. We improved our communication skills in front of strangers, learners came from different schools and this helped us not to get into cultural shock at University."*

*"Online programs like MoMaths, quizzes, computer literacy was an advantage."*

The second cluster of community engagement projects recognises that the students in the Pre-University Programme are embedded in communities and families who face socio-economic challenges. These projects have aimed to improve health and safety, to promote cultural activities, and to foster infrastructure and economic development in the neighbourhoods in which learners live, and schools are located.

Projects and activities are conducted primarily through the Clinics located on the Mamelodi Campus, and serve the community on an ongoing basis while providing training for UP students. The training is either part of service learning for undergraduate students enrolled in a number of the professional programmes at UP that require practical experience before students complete their degrees or are part of master's or doctoral studies.

In brief, the following Clinics, hosted by UP faculties, have operated on the Mamelodi Campus:

- Animal Health Clinic (Veterinary Science)
- Business and Entrepreneurship Clinic (Economic and Management Sciences)
- Law Clinic (UP Law)
- Itsoseng Psychology Clinic (Humanities)
- Siyathemba Occupational Therapy Clinic (Health Sciences).

The Clinics, and various outreach activities and ambulatory clinics, are examples of how the University has interacted with and supported local communities.

**The Mae Jemison Science Reading Room**

Perhaps one of the most outstanding projects has been the Mae Jemison Science Reading Room, a facility for students and school learners in and around the Mamelodi community. Sponsored by the US Embassy, the facility was selected in 2013 as one of seven global 'Model American Spaces' through a project conducted by the Smithsonian Institute. The US State Department, through its embassies, interacts and engages with local communities and provides support, particularly through education and information-sharing, and the sites selected provided leading examples of innovative ways to achieve this.

As captured by Edwin Smith, the selection of the Mae Jemison Science Reading Room by the Smithsonian as a model of innovation was acknowledgement of the work undertaken in promoting science and “the rare and critical skills in our local communities — and that these efforts should be a model for our very own country and communities elsewhere on the continent”.<sup>4</sup>

Mae Jemison was selected in 1987 as one of the 15 people for the NASA Astronaut Group. She trained with NASA and worked on projects at the Kennedy Space Center and the Shuttle Avionics Integration Laboratory. On 12 September 1992, Jemison and six other astronauts went into space on the space shuttle Endeavor. This voyage made her the first African-American women astronaut.<sup>5</sup>

### Notable events

There were many notable events on campus in this review period, which were often hosted by Prof De la Rey in her capacity as Vice-Chancellor and Principal. Three are singled out here as illustrative examples:

- On 24 May 2015, on the occasion of the Africa Day Celebrations, the president of South Africa, then Hon Jacob Zuma, was hosted on the Mamelodi Campus. It was an important event, more so because the Mamelodi Campus was chosen to celebrate Africa Day, an annual celebration within the African continent to mark the formation of the Organisation of African Unity (OAU) on 25 May 1963 and the African Union in 2002. Africa Day is also an occasion to reflect on the progress of the continent to advance democracy, peace, stability, and socio-economic development.

Linked, at her Mamelodi Campus farewell hosted on 12 October 2018, Prof De la Rey captured the relevance as follows:

“Universities are by their very nature future oriented institutions — places for dreams about the future; dreams that transform lives. More than any other campus of UP, this should be a place where young talented people take the first step in realising their dreams. [...] Since my appointment I have taken a personal interest in moving forward a vision that the Mamelodi campus community was and is an integral part of the larger University of Pretoria community ... The mission and vision of this campus is what will be the cement that glues and knits us together to make real change in our communities and in the country.”

- In association with the Nelson Mandela Foundation, the 14th Nelson Mandela Annual Lecture was held on the Mamelodi Campus on 17 July 2016, the eve of Mandela Day. The lecture on the theme ‘Living Together’ was delivered by the renowned philanthropist and global business leader, Bill Gates, to an august audience.
- On 27 July 2017, a UP management meeting enabled all UP senior managers, comprising members of the Executive, Deans and Directors, to visit the campus, learn about the new strategic orientation, and imagine new ways of engaging and supporting the academic project of the campus.

The development of the academic project of the Mamelodi Campus — and the Mamelodi Collaborative as anchor strategy — were major achievements in Prof De la Rey’s era. Her institutional leadership helped position the campus in a context-appropriate framework closely aligned with the University of Pretoria’s long-term strategy. Further, the anchor strategy between two cities in two countries helped leverage the teaching and research strengths of the respective partners to serve the needs of the communities where they are located.



Bill Gates, keynote speaker at the 14th Nelson Mandela Annual Lecture 2016, with Prof Njabulo Ndebele, former First Lady Graça Machel and Prof De la Rey

<sup>4</sup> [https://www.up.ac.za/news/post\\_1764248-mamelodi-campus-science-reading-room-selected-as-one-of-the-seven-leading-centres-in-the-world](https://www.up.ac.za/news/post_1764248-mamelodi-campus-science-reading-room-selected-as-one-of-the-seven-leading-centres-in-the-world)

<sup>5</sup> <https://www.womenshistory.org/education-resources/biographies/mae-jemison>

# Environment and support

- 1. Introduction
- 2. Education Innovation
- 3. Enrolment and Student Administration
- 4. Enterprises UP
- 5. Facilities Management
- 6. Finance
- 7. Human Resources
- 8. Information Technology Services
- 9. Institutional Planning
- 10. Internal Audit
- 11. Library Services
- 12. Research and Innovation
- 13. Residence Affairs and Accommodation
- 14. Security Services
- 15. Student Affairs
- 16. Transformation Office
- 17. TuksSport
- 18. University Relations

# 1 | Introduction

Support service departments play a crucial role in supporting the realisation of the University's vision and strategic goals, and in ensuring effective day-to-day operations. This chapter presents the service departments at UP and briefly highlights their evolution and successes.

As shown here, these departments at UP are diverse and offer a wide range of services to the university community. Services include academic and student support services, research and innovation services, human resources, staff and student wellness and safety, logistics, finance, information and knowledge management, planning, information technology and communications, sustainable development and governance and compliance.

The service departments at UP can be classified into three broad categories:

- *Student support services* — Library Services (also supports staff), Enrolment and Student Administration, Student Affairs, Residence Affairs and Accommodation, and TuksSport.
- *Staff support departments* — Human Resources, Research and Innovation (also supports postgraduate students), and Education Innovation.
- *Institutional support services* — Facilities Management, Information and Technology Services, Institutional Planning, Transformation, Finance, Security Services, University Relations, Enterprises UP, and Internal Audit and Compliance Services.

The diversity of the University's professional services reflects important institutional dynamics as well as evolving dynamics in universities' organisational environment, locally and globally. They include changing organisational structures, the increasing scope and diversification of institutional activities, governance imperatives, alignment with the policy environment, and the need to ensure the sustainability of universities and their effective functioning. The service departments thus have critical institutional capabilities which enable the successful pursuit of a university's vision and mission, enable institutional change and responsiveness, and support organisational effectiveness and sustainability.

At the University of Pretoria, a Directors' Management Committee (DMC) was established in 2013 to ensure effective

decision-making regarding cross-cutting professional service matters and to strengthen coordination and teamwork between the various professional services. The DMC ensures adequate consultation and input from the relevant professional services. Prior to the establishment of the DMC, there was a Directors' Planning Forum (DPF), but this was not a formal structure. The DMC started meeting formally in 2014.

At an Executive Retreat in 2019, there was an important shift in the nomenclature — instead of 'support' departments, service departments were designated as professional service departments. This change came into effect in January 2020.

The evolving roles and structures of professional service departments reported in this chapter highlight their continuous adaptation to ensure alignment with the University's strategy, responsiveness to new demands and changing contexts, and the need to continuously strengthen capacity. Almost all the departments underwent some form of restructuring as well as adjustments in the scope of their functions. Some of the major restructuring included the merger of the Bureau for Institutional Research and Planning (BIRAP), Quality Unit, Unit for Academic Planning and the Unit for Market Research in 2013 to form the Department of Institutional Planning; the merger of the Department of Academic Administration and the Client Services Centre to form the Department of Enrolment and Student Administration in 2015; and the merger of three campus companies — Enterprises at UP Trust, CE at UP, and BE at UP — to form Enterprises University of Pretoria (Pty) Ltd in 2016.

As indicated in UP 2025, the function of each professional service department is integral to achieving the University's long-term vision and strategic goals. During this review period, the University's professional service departments made significant strides in several areas, *inter alia*:

- Student success initiatives
- Student enrolment processes
- Fundraising and sustainability initiatives





- Infrastructure development, management and maintenance
- Community engagement
- Academic development and support for teaching, learning and assessment
- Quality assurance of the University's activities
- Strengthening of the University's IT capabilities
- Knowledge management initiatives
- Research and innovation support

- The University's anchor strategy
- Efficient administrative services.

It is not an exaggeration to claim that the achievements of the University during the period under review were, in no small measure, enabled by the work of professional services departments. During the nation-wide #FeesMustFall student protests of 2015 and 2016, which disrupted academic activities, professional service departments played a frontline role in ensuring institutional stability, the safety and well-being of staff and students, and continuity in teaching and learning and research.

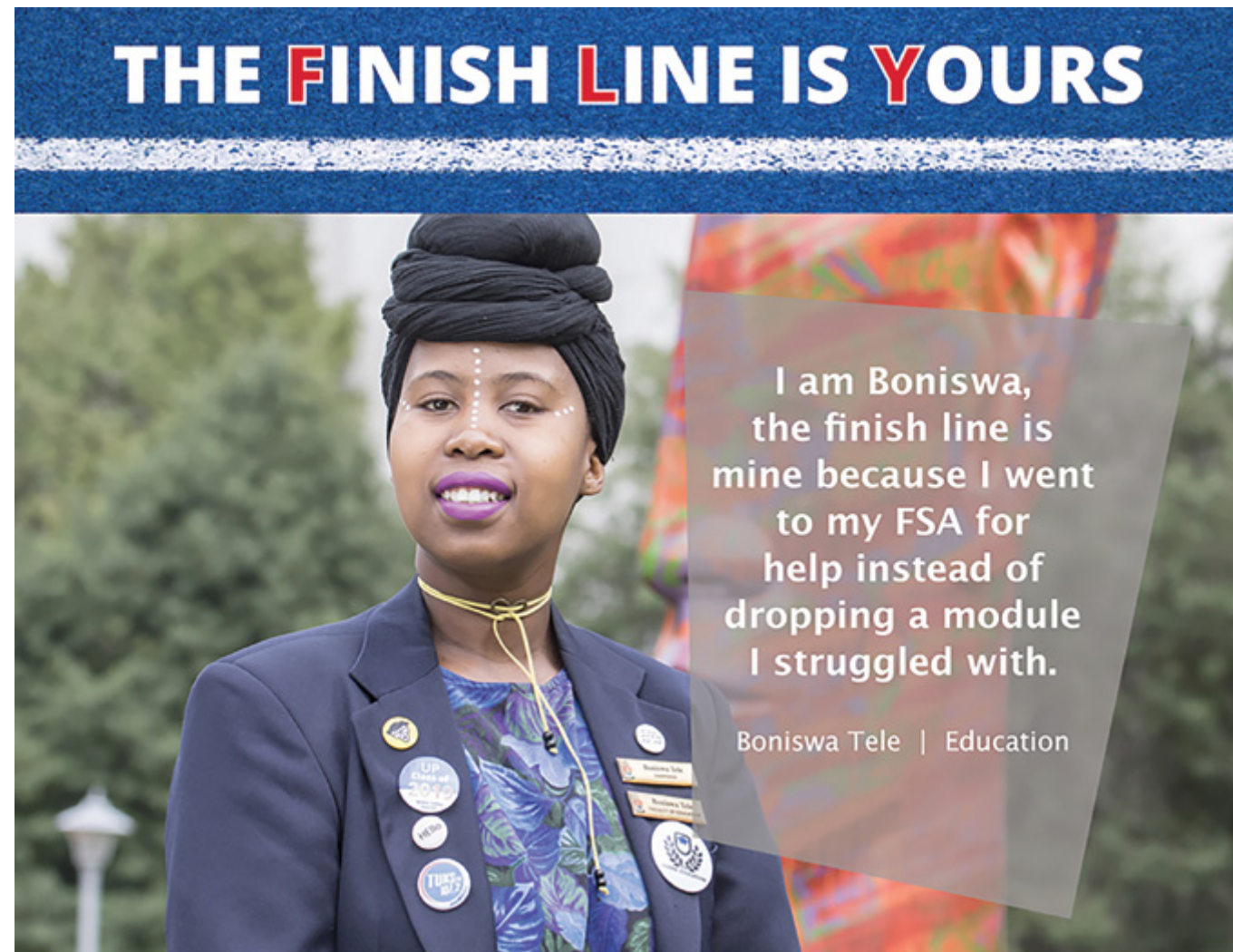

## 2 | Education Innovation

The Department for Education Innovation (EI) had existed, in 2018, for some forty years, albeit in continuously shifting guises.

The Department has always held the clear vision of promoting education excellence, and in more recent times, responding to a rapidly evolving society and ever-changing environment. This has been done through embracing the latest and best in global practices of integrating information and communication technology (ICT) into higher education institutions.

Education Innovation seeks to be a strategic resource, and during the period under review, the quality of its functional excellence and human capital contributed to the achievement of UP 2025.

In order to fulfil its mandate, the vision of EI had traditionally been to support and develop academic staff through leadership and expertise in order to facilitate more effective learning in both contact and online programmes. In 2012, the focus included, for the first time, the academic support and development of students. A planning event in March 2009, from which a ten-year strategy (2010–2020) would be generated, involved all members of the Department and a variety of University stakeholders.

The outcomes of an external quality review of the Department, conducted in October 2009, affirmed the productive relationships in the interactions between EI and key University departments. This aligned with the Department's vision for 'creating synergy'. An example of this is the way in which EI provides professional learning opportunities to academics, in collaboration with the deputy deans responsible for teaching and learning, within and among faculties and relevant role-players around campus. These outcomes would later resonate with the goals set out in UP 2025.

### Structure and functioning

The structure of the Department changed somewhat between 2009 and 2018:

- The Educational Technology Unit transferred to Information Technology Services (2009)

- The Community Engagement Office was incorporated into the Department (2011)
- Student academic development was added to include both staff and student development (2011/2012)
- The Creative Studios and Communications Technology Unit was reduced in size (2012/2013).

In 2018, at the end of the period under review, the structure was as follows:

Prof Wendy (W) Kilfoil was Director from 2009 to the end of October 2018, when she was succeeded by Prof Gerrit (G) Stols.

In 2009, only one of the two deputy director positions was filled, by Dr Matete (M) Madiba. She was succeeded by Dolf (D) Jordaan (2013). The second position was filled by Prof Ana (A) Naidoo (late 2011). They were responsible, respectively, for the portfolios of E-Learning and Media Development, and Academic Development — both remained in place beyond 2018.

### Highlights

There were several highlights during the period under review in terms of strategic objectives and their achievement. These are briefly described below.

### Student success

The Vice-Principal: Teaching and Learning, Prof Nthabiseng (NA) Ogude, to whom EI reported, formed a steering committee for Student Access and Success (2009), assisted by the head of the Higher Education Research and Innovation (HERI) Unit within EI. Funding from the Department of Higher Education and Training (DHET) became available

to the University for the first time in 2009 in the form of an earmarked Teaching Development Grant (TDG). The TDG would from 2018 be known as the University Capacity Development Grant (UCDG). Between 2009 and 2018, the grant was managed by the director of EI. It enabled several student success projects such as tutoring and advising. A strategy to appoint student counsellors in faculties was initiated during 2009, whereafter they were soon renamed Faculty Student Advisors. Although appointed in the faculties, they were convened as a community of practice by EI. Advising of this nature was an innovation born at UP that has now spread throughout the country.

The Deputy Director: Academic Development, Prof Ana (A) Naidoo, integrated initiatives such as orientation, the coordination of advisors and the training of tutors. First-year orientation moved to EI (in 2011/2012) and became more academic in focus; later, an extended online orientation was added, known as UPO (2014). In 2017, EI initiated a version of UPO for use by students provisionally accepted by UP but not yet registered.

The student success projects were consolidated, expanded, and then rebranded as the Finish Line is Yours — FLY@UP (2016), focusing on students taking responsibility for completing their degrees in the minimum time using all the support available at the University.

During the period under review, Prof Naidoo managed major student success projects funded by donors. The Michael and Susan Dell Foundation funded two programmes for NSFAS students: from 2012, the Dell Young Leaders programme, which supported students with a top-up for fees and wraparound services and, from 2016, the Sikelela Scholars programme, which provided wraparound services only. A further two, fully funded projects, were added: the MasterCard Foundation Scholars programme, inaugurated in 2013/2014 as a ten-year project, and the Ikusasa Student Financial Aid Programme, which started in 2017. At the end of the period under review, these programmes had ensured above average success for hundreds of students.

From 2009, work done by HERI resulted in the notion of high-impact modules (high enrolments, usually first-year, serving multiple programmes), which became the unit of analysis for much of the student success work. The Student Academic Readiness Survey (STARS) was designed by HERI and implemented during orientation, from 2010, to act as an early warning system so that students at risk could be directed to relevant assistance (mentoring and advising). Major data-based student success research was undertaken by HERI over the years. Dr Juan-Claude (J) Lemmens, Head of HERI, was chosen by the Vice-Principal: Academic to chair the Tshebi Data Analytics Committee from 2016, in acknowledgement of his work.

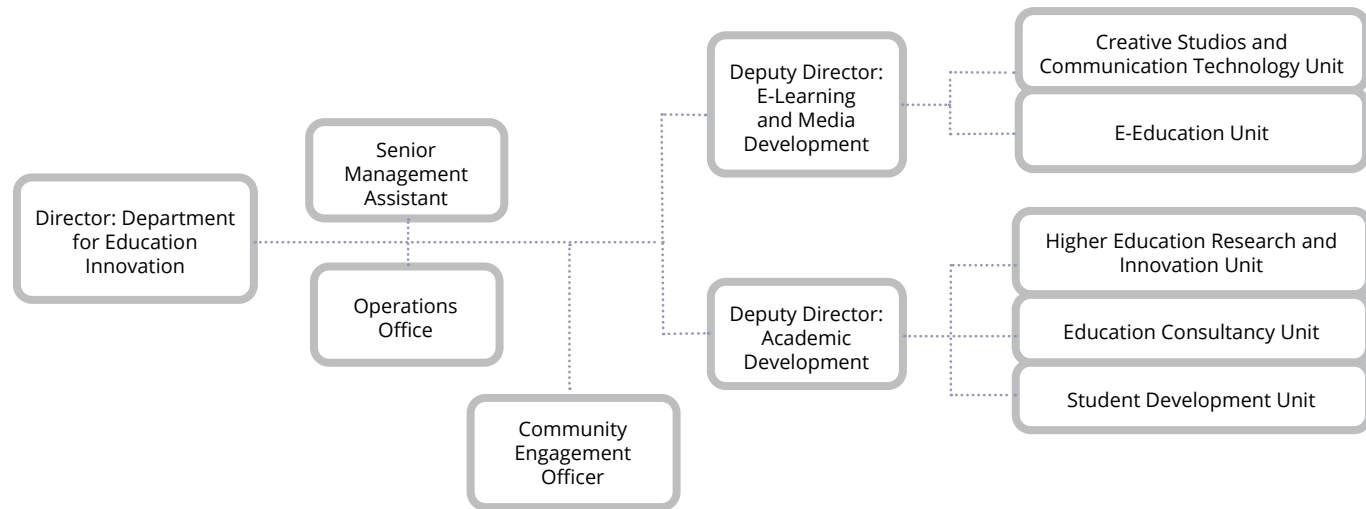

Structure of the Department for Education Innovation in 2018

Prof Wendy Kilfoil, Director Education Innovation, 2009–2018



Prof Gerrit Stols, Director Education Innovation, 2018–



- From 2016, CE also underwent a slight refocusing to support the University's anchor strategy, initially centring many activities around the Hatfield Campus and some around the Mamelodi Campus.

The sheer size of CE at the University, its developmental philosophy of partnering equally with communities to solve real problems, its relationship to credit-bearing modules, its effective management, and the impact on the local economy made it a leader in the field in South Africa during the review period.

### Policy engagement

EI led the revision of a variety of teaching-related policies throughout the period under review. All were approved by the Senate. The policies included:

- The Community Engagement Policy (approved in 2013)
- The Teaching and Learning Charter: Undergraduates (approved by Senate in 2015)
- The Educational Technology Policy (approved in 2015)
- The Teaching Continuity Protocol (approved in 2016).

### E-learning and online assessment

The University first invested in e-learning and online assessment in the 1990s to promote technology-enhanced blended learning:

- In 2009, only 45% of academic modules at UP had a clickUP component; in 2018, that proportion had risen to 94.43%. In the same year, EI also invested in synchronous software, later to become Blackboard Collaborate™. The gradebook feature of clickUP was implemented from 2010. The e-learning platform, based on Blackboard Learn™, was

### Community engagement

The incorporation of community engagement (CE) into EI was part of the consolidation of support service departments (2011). Gernia (G) van Niekerk was head of the programme throughout the period under review. The following illustrates the scale of activities:

- In 2011, 7 500 students were performing CE for academic credit; this number would grow to 17 403 by 2018. Thousands of other students supported activities as volunteers.
- Linked to CE, the University was affiliated with the South African Higher Education Community Engagement Forum and the international Tailleres Network of Engaged Universities.
- In 2016, UP became the only university in Africa to be invited to be a member of the University Social Responsibility Network.

branded as clickUP. Initially hosted on campus, clickUP was moved to a Blackboard managed hosting offsite in 2016.

- While Blackboard Learn™ has a quiz tool, the University uses other assessment tools too. In 2009, Umfundi was used for computer-based testing but was later replaced by QuestionMark Perception™ in 2012 (branded as QuestUP).
- In 2018, UP celebrated 20 years of online learning, with members of the Blackboard Executive attending several events organised by EI.

### Hybrid teaching and learning

The University's teaching approach was branded as hybrid learning in 2014: a planned combination of contact and online teaching and learning. In support of a hybrid approach, an instructional design project manager in EI worked on an innovative coursework master's programme from 2016 to 2018.

With funding from the TDG, the first *Flexible Futures* conference was hosted in 2014, focusing on achievements in hybrid teaching and assessment. The conference has since been held annually.

In 2017, the University received a grant from the Carnegie Corporation of New York (CCNY), along with three other universities, to investigate the impact of the Fallist movement on the uptake of hybrid and blended learning.<sup>1</sup>

### Research and learning analytics

EI was also a national leader in learner and learning analytics in the period under review. The Department's work on learner and learning analytics received a boost when the University obtained a Siyaphumelela grant from the Kresge Foundation in 2014 to use data to promote first-year student success. The grant was administered by the EI Director, Prof Kilfoil.

Among other achievements, HERI designed the early warning survey, STARS; conducted a longitudinal survey on students who dropped out; and performed a cluster analysis mid-year to identify at-risk students. With support from the TDG, EI was able to pilot learning analytics, first, with Blackboard Analytics for Learn™ (2013) and later, with Blackboard Predict™ (2018).

Prof Kilfoil, working with the head of HERI, Dr Juan-Claude Lemmens, and the head of e-learning, Dolf Jordaan, launched the first South African Higher Education Learning Analytics (SAHELA) event at the University in 2013, in concert with the Learning Analytics Summer Institute of the Society of Learning Analytics Research (SoLAR). Dr Lemmens and Mr Jordaan continued to run a pre-conference SAHELA workshop at the South African Association for Institutional Research conference until 2018.

### Recognising excellence

EI supported academic staff from the start of their appointment, through the occasion of their promotions, up until the recognition for their achievements. EI continued to organise the flagship academic induction programmes for newly appointed academics throughout the period under review, in consultation with the deputy deans for teaching and learning.

Teaching Laureate Awards had been organised for many years by EI but from 2013/2014, became part of the annual institutional achievers' awards. EI remained involved in drawing up criteria and assisting applicants to prepare portfolios.

Teaching and learning quality at UP was demonstrated to the higher education sector through the Quality Enhancement Project of the Council on Higher Education (CHE). The Director of EI led both phases of the project at the University (2014 and 2018). This multi-stakeholder project at UP resulted in two reports to the CHE, both published on their website.

Each year, EI staff members attend training and conferences, present papers, and publish. Between 2009 and 2018, 52 papers were published in peer-reviewed journals, predominantly in the field of e-learning but also on professional development, analytics, student success, and teaching and learning. The following are five of the more highly cited:

- Nagel L and Kotzé TG. 2010. Supersizing e-learning: What a Col survey reveals about teaching presence in a large online class. *The Internet and Higher Education* 13(1):45-51.
- Lemmens J, Du Plessis GI and Maree DJF. 2011. Measuring readiness and success at a South African University. *Journal of Psychology in Africa* 21(4):615-621.



- Ogude NA, Kilfoil WR and Du Plessis G. 2012. An institutional model for improving student retention and success at the University of Pretoria. *International Journal of the First Year in Higher Education* 3(1):21-34.
- Lemmens J and Henn M. 2016. Learning analytics: A South African higher education perspective. *Institutional Research in South African Higher Education — intersecting contexts and practice* pp 231-253.

- Le Roux I and Nagel L. 2018. Seeking the best blend for deep learning in a flipped classroom — Viewing student perceptions through the Community of Inquiry lens. *International Journal of Educational Technology in Higher Education* 15(1):16.

<sup>1</sup> Scheepers D, Kriel D, Nagel L, Pretorius G, Smart A and Thukane M. 2016. Use of blended learning during #FeesMustFall. University of Pretoria Case Study Report.

### 3 | Enrolment and Student Administration

The Department of Enrolment and Student Administration (DESA), previously known as Academic Administration (AA), is a key support service and institutional enabler of UP's enrolment growth strategy. In the period under review, changes were made in both structure and personnel to keep in step with growing student enrolments, in line with the long-term strategy of the University. Meeting the planned enrolment targets required careful planning and management, which included achieving an optimal balance between professional and academic programmes, increasing student access and diversity, identifying talented students for study at UP.

Planned enrolment growth until 2025 included the following targets: contact undergraduate numbers would grow by an average of 1.4% per annum until 2025, and contact postgraduates by 2.2%, which would result in approximately 55 000 students on campus. The number of distance education students was also expected to rise to about 20 000, which would result in the University having a total enrolment figure of 75 000 by the end of the strategy's lifespan.

#### Focus and strategy

In line with the CHE's mandate to review the Higher Education Qualifications Framework (HEQF) and establish a sub-framework for the higher education sector, Academic Administration, in 2011, launched a major institutional project to ensure alignment of all academic offerings with the new Higher Education Qualifications Sub-Framework (HEQSF).<sup>2</sup>

During this period, the PeopleSoft™ system was further expanded under an ongoing Systems Renewal Project by Information Technology Services (ITS), with several modules added and implemented, especially with a focus on student self-services. In 2012, students were able for the first time, to apply online for admission on the PeopleSoft™ system, followed for the first time, by online registration in 2013. Other systems developments included online contracts and integration between PeopleSoft™ and the Syllabus Plus scheduling software.<sup>2</sup>

In 2014, the Executive approved one of the major strategic projects for the period under review, the Optimise Student Services (OSS) project. The OSS project was undertaken with the help of Deloitte, and recommendations submitted to the UP Executive by Prof Chris (CR) de Beer regarding the way forward. The OSS project entailed developing an integrated operating model for the departments of Academic Administration and the Client Services Centre (CSC), which culminated in their merger as DESA in 2015.

The new DESA consisted of four divisions that were functionally aligned in order to support the University's strategic goals and strategies. This was achieved through two main functions, namely Strategic Enrolment and Student Administration. These functions were serviced through the Student Services and Communication Division and supported by the Student Systems Division.

The new structure remained decentralised, with Faculty administrative staff reporting functionally to DESA. The integrated structure enabled DESA centrally to:

- Coordinate, standardise and simplify enrolment processes
- Standardise administrative services and processes across faculties
- Leverage student systems and capitalise on efficiencies and effectiveness in terms of automation and self-service
- Provide integrated services to clients, students and staff.

<sup>2</sup> The CHE was mandated in 2010 to review the HEQF; its mandate in terms of section 27 of the NQF Act was, among others, the development of the sub-framework; the development and implementation of policy and criteria for the development, registration and publication of qualifications (i.e., standards setting, including the development of naming conversions for qualifications); and ensuring the development of qualifications as required for the higher education system.

#### Structure and leadership

During the period under review, the Department of Academic Administration continued to function under the Director, Dr Dawie (DD) Marais, until 2015, when DESA was formed through the amalgamation of AA and the CSC. In 2018, Cila (C) Myburgh was appointed as the first director of DESA.

#### Academic Administration, 2009 to 2015

Academic Administration consisted of four sections, as illustrated in Figure 5.2.

The executive line-management function was in the portfolio of the Registrar, Prof Niek (N) Grové during this period.

#### Enrolment and Student Administration, 2015 to 2018

During 2015, the human resources restructuring project was launched to ensure that staff of DESA were placed within their new structural and functional environments. The appointment

of DESA's new management team — a director and four deputy directors — was made in the latter part of 2015, as follows:

By 2016, DESA was operationally functional and reported to a new member of the Executive, Prof Carolina (C) Koornhof, who was also responsible for the Department of Finance, and Business Enterprises.

In January 2017, DESA created a new one-stop off-campus registration centre at the Hillcrest Campus, previously also known as the LC De Villiers Campus. This initiative was a massive collaborative effort between multiple service departments and all faculties, with the overall coordination and management of the Registration Support Centre being DESA's responsibility. Temporary structures, tents, facilities, infrastructure, parking, catering, and other support structures had to be erected and operationalised in a very short time to ensure the Centre was functional and open to the public on 18 January 2017. This was a highly successful innovation that ensured a seamless registration and enrolment process.

Cila Myburgh, first Director of DESA



Dr Dawie Marais, Director of Academic Administration



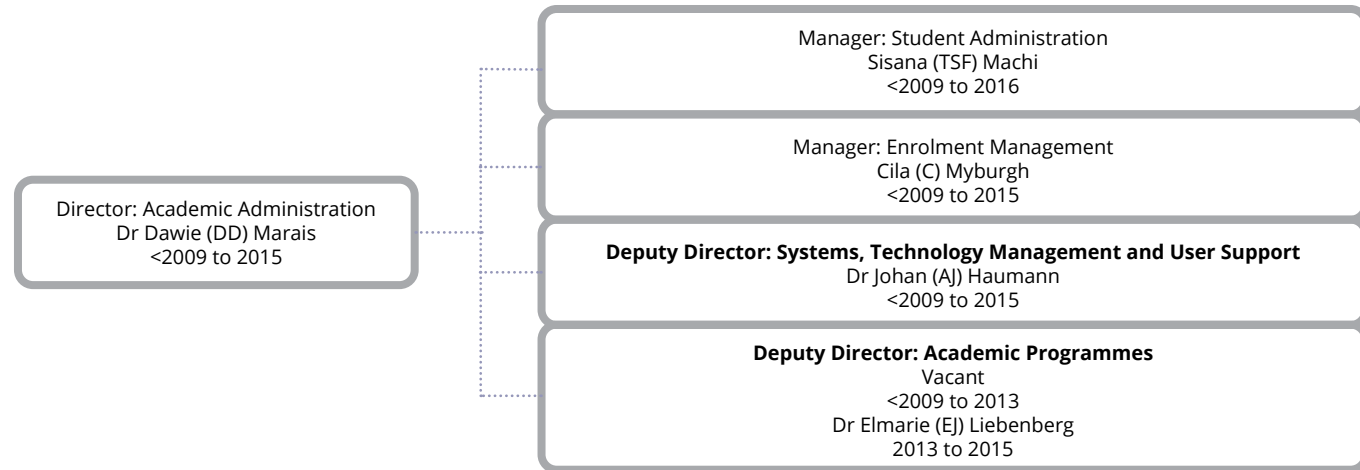

Structure of the Department of Academic Administration from 2009 to 2015

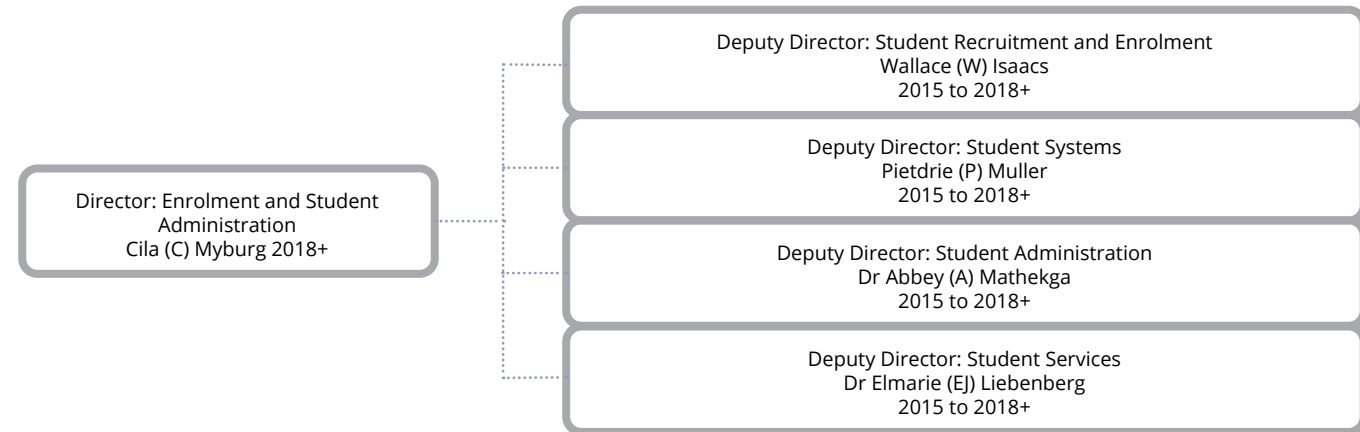

Structure of the Department of Enrolment and Student Administration from 2015 to 2018+

### Enrolment targets and strategies

During 2017, DESA focused strongly on initiatives and strategies to ensure that the University's enrolment targets were met through the launch of the #ChooseUP campaign. The result of the successful rollout of the #ChooseUP campaign was evident by an increase of 2% in the overall realisation rate. This indicated that more students had chosen to register at UP than in previous years. Furthermore, the realisation rate of top achievers was also met, thereby signifying UP as the institution of choice. This rate is measured by the number of top achievers i.e., students with six or more

distinctions ( $\geq 80\%$ ), including Life Orientation, choosing UP as first-time entering students, who were in Grade 12 in the previous year. The campaign subsequently became an annual event, and in 2018, also had a significant impact on the realisation rate of UP-admitted students.

A newly developed and automated Online Application System opened for applications, for the 2018 intake, on 1 March 2017. The Online Application System made use of application and admission requirement rules to screen and route applications based on basic criteria and quality, and to manage the number of applications more effectively into programmes.

In a subsequent survey performed by the Department of Institutional Planning, UP's system was ranked by users as the easiest online application system to use out of all South African universities.

With respect to exit strategies, in 2017, the Career Services Division became the driver of the Ready for Work campaign in support of the UP Employability drive. Two marketing campaigns were rolled out for the Ready for Work programme, highlighting skills training and entrepreneurship. These programmes were further developed in 2018 and, in collaboration with Enterprises UP, four free online

skills courses were offered with more than 2 000 students benefitting from this proactive intervention.

Overall, DESA's portfolio covers the full student life cycle: from applications through to graduations and career services. As a professional services department, it plays a pivotal role in supporting the University in achieving its strategic goals. The merger of Academic Administration and the Client Services Centre into DESA ensured that sound, effective, and efficient administrative practices would be at the core of UP during the period under review and beyond.



Prof Cheryl de la Rey, Prof Tinyiko Maluleke and Kwena Moloto, SRC Chairperson, UP Welcome Day, 2017

## 4 | Enterprises UP

In 2008, the year prior to the period under review, the University created a commercial hub as an enabling platform for the development, implementation, management, and governance of the University's business activities. The entity would be registered and named the Enterprises at University of Pretoria Trust. The Enterprises at UP Trust was founded in 2008 and became operational as the official corporate holding entity of the UP group of companies.

The Trust was mandated to:

- Take responsibility for the development, implementation, and management of the University of Pretoria's business activities; and
- Govern and manage the campus companies of UP, which included contract research services and continuing education programmes.

Included in this group were two companies that were created earlier to service those who wanted to continue their education through diverse programmes, and one that leveraged UP's research capacities for commercial purposes: Continuing Education at UP Trust (CE at UP), and Business Enterprises at UP (Pty) Ltd (BE at UP), were the two companies responsible for this, respectively.

### Structure and functioning

Until 2015, the Trust was governed by a Board of Trustees, made up, at different intervals, as follows:

*Johan (JS) Nel (Chairperson until 2008)*

*Prof Chris (CR) de Beer (Chairperson until 2010)*

*Prof Cheryl (CM) de la Rey (Chairperson until 2015)*

*Prof Ramaranka (RA) Mogotlane*

*Prof Sibusiso (S) Vil-Nkomo*

*Prof Nthabiseng (NA) Ogude*

*Patience (TP) Mushungwa*

*Deon (D) Herbst (CEO).*

In January 2016, Enterprises at UP Trust, CE at UP, and BE at UP were merged into one holding company called Enterprises University of Pretoria (Pty) Ltd, colloquially known as Enterprises UP.

Enterprises UP was formed in accordance with UP leadership at the time, as a central structure, with the following business objectives in mind:

- To manage and execute continuing education activities, commercial research, and consulting services
- To create brand awareness through interaction with industry and government, both nationally and internationally
- To generate third-stream revenue for the University of Pretoria.

With the evolution of Enterprises UP, the Board of Trustees was replaced by a Board of Directors, the members of which are appointed by the 100% shareholder, the University of Pretoria. The Board of Directors at consolidation consisted of Prof Norman (N) Duncan (Chairperson), Prof Carolina (C) Koornhof, Prof Vil-Nkomo, Prof Ogude, and Mr Herbst (CEO). The Board of Directors was and remains responsible for formulating, supporting, and aligning a policy for the company which supports University policies.

### Shifting knowledge to insight

The University's legacy of contributing to solutions continued to endure through a cluster of innovative and multidisciplinary services, rendered by Enterprises UP. Research and training solutions translate into increased productivity and enhanced customer service excellence within any industry. Drawing on the knowledge of academic and industry experts from the University, Enterprises UP's track record includes high-quality, customised, and practical solutions that set UP apart from traditional skills development and research organisations.



TuksFM, winners of the Campus Station of the Year award 2012, 2013, 2014 and 2016

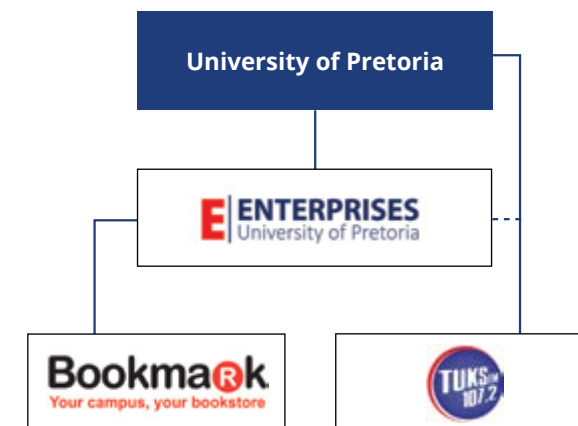

The Enterprises University of Pretoria (Pty) Ltd, as in 2018

- *Research Solutions* provides a total solution focused on solving the day-to-day challenges of industry, informed by the latest in knowledge generation and knowledge developments born from UP's broad research outcomes.
- *Training Solutions*, in association with academics from the University, is committed to lifelong learning, maximising career growth opportunities, and taking knowledge to the next level. Training and career development services are provided to both the public and commercial sectors, globally, through quality, career-focused courses that address skills shortages worldwide.

### Bookmark at UP (Pty) Ltd

Bookmark at UP (Pty) Ltd is a joint venture between Enterprises UP and Van Schaik Bookstore (Pty) Ltd. In January 2009, Bookmark at UP started trading on the Hatfield Campus. Bookmark at UP aligns the strengths of an academic institution with the commercial architecture of a national industry partner, to provide students with the highest quality service as it relates to the needs of an academic career. Subsequently, additional bookstores were opened and Bookmark at UP stores are now available on four of UP's campuses.

### Tuks FM Trust

Tuks FM is UP's community radio station and has been broadcasting successfully since 1981. It broadcasts under licence of the Independent Communications Authority of South Africa (ICASA). In 2011, Tuks FM migrated from the Department of Student Affairs of UP to become a sustainable, self-funded entity.

During the period under review, Tuks FM won the coveted Campus Station of the Year award in 2012, 2013, 2014, and 2016.

### Highlights

There were many highlights during the period under review; the following is a list of some of the more notable achievements:

- After the 2009 institutional audit by the Council on Higher Education (CHE), the University received a commendation for its quality processes, which included the activities of CE at UP.

Deon Herbst, CEO Enterprises UP



- During 2011, Enterprises UP received accolades for its support to Education Innovation in the preparation of UP lecturers for the transfer to the new ClickUP platform.
- Between 2012 and 2018, Enterprises UP acted as the Short Course Awards African delivery partner for UniQuest (Pty) Ltd (University of Queensland, Australia).
- In 2013, the University was proudly announced as the first in Africa to join as a SAP Education Partner for e-Learning at the SAP Education Partner Enablement and Software Product Value Chain event. In the same year, Enterprises UP received provider accreditation from the Local Government Sector Education and Training Authority (LGSETA) for the presentation of the Municipal Finance Management Programme. Also in the same year, and the following the inception of a flagship project of Corporate Social Investment (CSI) at Enterprises UP, a total of 64 school principals successfully completed the exclusive Leadership Development Programme for School Principals.



- In 2014, the Tshepo 10 000 project equipped 10 644 unemployed City of Tshwane youths with entrepreneurial skills. It also undertook an air-quality monitoring study for the proposed Kudu Combined Cycle Gas Turbine (CCGT) power station at Uubvlei, Namibia. In the same year, Enterprises UP administered the commercialisation of the hearScreen™ mobile health solution, an innovation of Prof De Wet (DW) Swanepoel in the Department of Speech-Language Pathology and Audiology at UP.
- In 2015, Enterprises at UP managed the drafting of the Third Amendment Bill to the Children's Act of South Africa, in collaboration with Prof Ann (A) Skelton at the Centre for Child Law at UP.
- Also in 2015, an agreement with the Australian National University (ANU) for the delivery of the Australia Awards-Africa Short Courses in Minerals and Energy Economics was concluded. Two years later, during 2017-2018, Enterprises UP and ANU jointly presented a Minerals and Energy Economics short course as part of this programme.
- In 2016, Enterprises UP assisted the Namibian National Commission for Research, Science and Technology (NCRST) with the revision of the Namibian national

research, science and technology policy. In the same year, it became the first provider in South Africa to develop and present the National Credit Regulator Debt Counsellor Training online. Also in 2016, Enterprises UP completed with appointed partners a World Health Organisation (WHO) project that supported the development of the National Strategic Plan/Framework (NSP) for HIV, tuberculosis (TB) and sexually transmitted infections (STIs).

- Enterprises UP was involved in a research project that was the joint winner of the Innovation in Concrete category at the Fulton Awards 2017, for design and other uses of concrete.
- Also in 2017, Enterprises at UP launched the Ready for Work Programme, in collaboration with the UP Department of Enrolment and Administration Services. By 2018, more than 1 000 UP students had enrolled in the programme's specific work readiness content packages, and more than 1 800 had enrolled for the free online entrepreneurship package.
- In 2018, the University's Department of Architecture, and the Enterprises UP research project, NZASM Footsteps along the Tracks, 1887-1899, received the Corobrik

South African Institute for Architecture (SAIA) Award for Excellence in Architecture.

- In the same year, the Professional Online Development (PODs) trademark was registered in four categories. Also in 2018, and following two years of implementation spearheaded by Enterprises UP, the University was a Gold winner in the prestigious Gauteng Premier's Service Excellence Awards, in the subcategory 'Building Safe Communities' for its urban renewal and social transformation project around the Hatfield Campus.

### International footprint

The international footprint of Enterprises UP reflects engagements with 106 countries, since 2008. In 2018, international research and training collaborations, agreements and partnerships for current and future initiatives reached as far as Australia, Finland, Germany, and the USA. Multiple projects were also completed in neighbouring countries, including Botswana, Namibia, Swaziland and Zimbabwe. Other initiatives were undertaken further afield in Africa, with research projects and training programmes rolled out in Ghana, Kenya, Malawi, Tanzania and Uganda.



## 5 | Facilities Management

The vision of the Department is to be a quality-driven leader in higher education estate and facilities management, which benchmarks favourably nationally and internationally. It is a multidisciplinary department that has been positioned to coordinate all estate and facility-related services at the University. In this role, the Department sees itself as responsible for providing these services at strategic, tactical and operational levels to the entire university community whilst integrating the needs for facilities, services and infrastructure into a single, comprehensive spatial development plan to support the University's strategic plan at all times.

The UP 2025 strategic plan states that spatial infrastructure and physical facilities are central to providing the environment within which students and staff can excel to achieve the University's academic mission.

### Structure and leadership

By 2009, the Department was structured into four divisions, with Philip (PA) Nel as the Director. Mr Nel was appointed from 2008 until the time of his retirement in 2013. He was supported by four deputy directors and a specialised project manager, Prof Schalk (SJ) Claasen, responsible for large institutional projects. Prof Susan (SA) Adendorff, formerly Head of the Procurement Division within the University, was appointed to succeed Mr Nel when he retired at the end of May 2013. The structure of the Department remained unchanged until the end of 2017 when the number of divisions was reduced from four to three. From 2009 to 2017, the Deputy Directors were:

- Deputy Director, Planning and Administration — Hennie (HS) Coetzee from 2009 to 2015. He was succeeded by Nicolaas (N) Bester in September 2015.
- Deputy Director, Project Management — Marcel (MF) Theron from 2009 to 2017.
- Deputy Director, Maintenance and Operations — Willem (WJ) Lübbe from 2009 to October 2013. He was succeeded by Ludolf (PL) van der Merwe.
- Deputy Director, Campus Services — Wessel (WJ) Oosthuizen from 2009 to 2017.

From 2009 to the end of 2015, the Department formed part of the portfolio of Prof Antonie (AM) de Klerk, the member of the University Executive responsible for Facilities, Information Technology, and Sport. Following his retirement, the Department was overseen at various times by the then Registrar, Prof Niek (N) Grové, and the Vice-Principal: Institutional Planning, Prof Anton (A) Ströh.

Philip Nel, Director Facilities Management, 2008-2013



Prof Susan Adendorff, Director Facilities Management, 2013-



The Department experienced major changes after the #FeesMustFall campaign of 2015/2016, which led to the decision to insource many of the contracts that had been outsourced since 1998. Over a period ranging from April 2016 to December 2018, the number of staff members in the Department increased from 82 at the end of 2009 to 1 130 by the end of 2018. Several changes were also forced upon the Department as a result of a moratorium on the filling of vacancies, and a number of senior staff taking early retirement. As a result, by the end of 2017, the Department had to restructure into three divisions, coinciding with the retirement of the institutional project manager, Prof Claasen, in September 2017. The restructuring led to the following structure:

- Deputy Director, Campus Planning and Development — Nicolaas Bester
- Deputy Director, Technical Services — Ludolf van der Merwe
- Deputy Director, Campus Services — Wessel Oosthuizen.

Project Management, and Planning and Administration, were thus merged into one division. Technical Services and Campus Services were the divisions most affected by the insourcing, not only by the number of insourced staff members but also the scope of operations.

### Campus spatial development planning

#### Surface coverage

By the end of 2009, the land owned by the University of Pretoria covered 1 188 Ha with the gross floor area of the buildings on all campuses totaling 872 864 m<sup>2</sup>. The University's property portfolio comprised 632 buildings. During the period leading up to the end of 2018, various property acquisitions and disposals took place, and many new buildings were added to the portfolio (more detail is provided on pages 436 to 439). This meant an increase in land owned by the University to 1 192 Ha, the number of buildings increased to 703 and the gross floor area increased to 995 214 m<sup>2</sup>.

Of the 703 buildings owned by the University by the end of 2018, 282 had been erected more than 60 years before, making these buildings subject to the National Heritage Resources Act (Act No. 25 of 1999).

During the period under review, the Department executed 1 849 infrastructure projects to the value of more than R4 billion. Many of these projects were co-funded from Infrastructure and Efficiency Grant (IEG) funding as awarded by the Department of Higher Education and Training (DHET).

Throughout 2012, the University conducted a campus master planning exercise. As a result of this project, certain priorities were proposed to the UP Executive and Council for consideration, and subsequently, high-level costing estimates were developed.

In March 2013, the DHET informed all South African public higher education institutions that each university had to submit audits and plans related to its infrastructure to the Department by the end of July 2014. The following needed to be included:

- An infrastructure audit in line with funding allocation for disability infrastructure to provide universal access
- A comprehensive maintenance plan outlining how old and new infrastructure would be adequately maintained
- Comprehensive infrastructure audits and submitted campus masterplans
- Medium and long-term infrastructure plans in line with an institution's growth trajectory over the next 10 to 20 years; the latter would be used by the DHET as a basis for the next infrastructure funding cycle.

During this time, the University of Pretoria revisited the campus masterplans developed in 2012 and developed campus masterplans in much greater detail for all its campuses.

These plans were developed against the backdrop of the University's enrolment plan to 2019, as had been agreed with the DHET, as well as the growth trajectory included in the University's strategic plan, UP 2025. Since the request from DHET asked for longer term planning, the growth projections were extrapolated to 2030.

To ensure that the proposed expansions provided in the campus masterplans could be executed, a detailed audit of the services and utility infrastructure on all UP campuses was conducted. The result of this audit and the campus masterplans provided a ten-year plan for the refurbishment and upgrading of the services infrastructure. Furthermore, given the age profile of the University's building stock, an assessment of the deferred maintenance was done. The state



of the University's residences was specifically addressed. Finally, a full audit of universal accessibility of all UP facilities was conducted. In addition, a quantity surveyor was tasked with estimating the cost of aligning all UP facilities to the latest guidelines on universal access.

Based on the report submitted to the DHET in 2014, significant funding was allocated to deferred maintenance and bulk infrastructure upgrades in the IEG4 and IEG5 funding cycles. Details on the deferred maintenance and bulk infrastructure upgrade projects are given below.

In 2018, the Department embarked on a revision of the campus masterplans that had previously been prepared. This effort would eventually culminate in a revised masterplan for the University which was to be submitted for approval to the UP Council in 2019. The plan would henceforth be known as the UP Campus Spatial Development Plan.

### Sustainability awareness

#### Energy consumption

Before 2009, Facilities Management embarked on various initiatives to curtail energy consumption on its campuses. By 2012, the consumption was 101.32 kWh/year/m<sup>2</sup>. During the period under review, energy consumption peaked at 105.16 kWh/year/m<sup>2</sup> in 2015. By 2018, further initiatives had reduced the consumption to 97.88 kWh/year/m<sup>2</sup>. This represents a reduction of almost 7%.

Actions taken to reduce the electrical consumption included:

- An energy consumption awareness campaign
- A project protocol implemented which included technical insight into renovation, upgrades, and new builds

## Hatfield Campus

### Projects funded from the University's own resources

Construction of the Thuto Building (lecture hall complex with 2 400 seats) (2010, R71m)

Repurposing of space to create a Research Commons in the Merensky Library (2010, R19m)

Refurbishment of the Botany Building (2012, R17m)

Refurbishment of Old College House to house the Centre for the Advancement of Scholarship (2012, R11m)

Refurbishment of Kya Rosa (2012, R1,3m)

Refurbishment of Old Agriculture Building kitchen (2012, R19m)

Refurbishment of the Club Hall (2014, R17m)

Refurbishment of House Nala (Klaradyn) and House Khutso (Jasmyn) (2014, R62m)

Closure of the Amphitheatre roof (2014, R3,6m)

Construction of bus terminus (2016, R11m)

Refurbishment of the JAKE Dining Hall (2016, R14,5m)

Upgrading of the Building Sciences Building (2017, R35m)

Refurbishment of the Monastery Hall (2017, R20m)

Upgrading of the Law Building exterior facade (2017, R24m)

Refurbishment of the IT Building (2017, R33m).

2007

Construction of the Engineering 3 Building and Parkade (IEG1, 2007, R170m)

2008

2009

Construction of the Plant Sciences Building (IEG2, 2009, R98m)

2010

2011

2012

2013

2014

2015

2016

2017

2018

### Projects funded by the University and industry partners

Construction of the Mining Industry Study Centre (2011, R73m), in collaboration with the Anglo-American Chairman's Fund, Glencore, CBI Electric and PPC Cement

Construction of the Virtual Reality Mining Laboratory (2013, R33m) in collaboration with Kumba Iron Ore.

### Projects funded from the IEG

Various projects were initiated and executed because of the opportunity to apply for IEG funding. In all instances the University was expected to co-contribute to the project cost. Many of these projects were approved as part of the drive to increase student numbers in particular faculties (for example, the School of Engineering).

## Hillcrest Campus

In 2013, the Hillcrest Campus became the collective name for the Hillcrest Sports Campus, the Experimental Farm and the Hillcrest Residences.

### Projects funded from UP's own resources

Construction of the TuksMonate Dining Hall (2011, R38m)

Construction of the Tuks Golf Driving Range (2012, R2,4m)

Upgrading of the athletics track in the BESTMED Stadium (2012, R14m)

Upgrading of the rugby stadium (2012, R15m)

Upgrading of the Rembrandt Hall (2013, R11m)

Construction of the small animal handling facility (2013, R11m)

Refurbishment of The Tower (Taaibos) and College (Kollege) residences (2015, R74m)

Upgrading of High Performance Centre (hpc) hotel and sports centre lockers (2015, R4m)

Construction of the compost yard (2015, R5,5m)

Rehabilitation of the Hartebeestspruit (2016, R9,5m)

Refurbishment of House Tau (Boekenhout) and Tuks Ekaya (Olienhout) residences (2016, R74m)

Conversions to accommodate the Sport, Exercise Medicine and Lifestyle Institute (SEMLI) (2017, R26m)

Upgrading of the Daan Swiegers Clubhouse (2018, R650k)

Refurbishment of the Morula Legae (Maroela) and Azalea (Katjeepering) residences (2018, R97m)

Repurposing of space in the Sports Centre to create a new data centre (2018, R5m).

2007

2008

2009

2010

2011

2012

2013

2014

2015

2016

2017

2018

### Projects funded by UP and industry partners

Construction of the Centre of Excellence for Cricket SA (2012, R25m)

Construction of new TuksSport High School and hostels (2013, R47m) with donation from the Athletics Foundation Trust

Construction of Assupol Tuks Cricket Clubhouse (2015, R12m) with sponsorship from Assupol.

### Groenkloof Campus

The Groenkloof Campus continued to accommodate the Faculty of Education.

#### Projects funded from the IEG

Construction of three new lecture venues in Aldoel Building, upgrading of laboratory facilities and IT laboratories (IEG2, 2009, R70m)

Repurposing of space to create a Research Commons in the Library (IEG3, 2012, R15m).

#### Projects funded from UP's own resources

Letlotlo Building refurbishment (previously known as the SACTE Building) (2013, R35m)

Installation on campus of a central standby generator plant (2018, R21m).



### Mamelodi Campus

The Mamelodi Campus continued to function as home to the extended academic programmes during the period under review.

#### Projects funded from the IEG

Upgrading of classroom and laboratory facilities, computer laboratories, the cafeteria, and the installation of a central standby generator plant with the construction of a new substation (IEG3, 2012, R34m).

#### Project funded by UP and the US government

Phase 2 of the Mae Jemison Reading Room (2014, R640k).

#### Projects funded from UP's own resources

Internal upgrading of the Arena Auditorium often used for the University's community outreach initiatives in Mamelodi (2015, R1,2m)

Upgrading of the Student Health Service facility (2015, R500k).



### Prinshof Campus

The Prinshof Campus remained home to the Faculty of Health Sciences during the period under review.

#### Projects funded from the IEG

Construction of a BSL 3 laboratory at Prinshof South (IEG2, 2009, R19m).

#### Projects funded from the National Skills Fund

HW Snyman North Skills Laboratory and Library refurbishment (2012, R17m)

Construction of the TuksBophelong residence (2012, R96m)

Construction of the Tswelopele Lecture Hall complex (2012, R184m)

Upgrading of HW Snyman North Levels 4 and 5 (2012, R44m)

#### Projects funded from the Clinical Training Grant

Upgrading of the cafeteria (2012, R27m)

Renovation of levels 3 and 5 in the Pathology Building (2012, R6,5m)

Refurbishment of the HW Snyman South Skills Laboratory (2014, R3,6m).

#### Projects funded from the National Skills Fund

Upgrading of the Basic Medical Sciences Building (2017, R116m).

#### Projects funded from UP's own resources

Upgrading of the Oral and Dental Hospital (2017, R36m).



### Onderstepoort Campus

The Onderstepoort Campus continued to accommodate the Faculty of Veterinary Science and the Onderstepoort Veterinary Hospital. Residences provide accommodation to some of the students of the Faculty.

Upgrading of various student facilities and laboratories (2012, R87m)

Construction of new residence (100 beds) (2013, R30m)

Phase 2 of the Mae Jemison Reading Room (2014, R640k).

Erection of the Lesedi Complex (2014, R86m).

Installation of a two-day back-up water supply (IEG4, 2017, R15m).



- An initiative to replace electro boilers with heat pumps
- The use of the latest technology in all HVAC<sup>3</sup> upgrades and replacement projects
- HVAC plants not running 24 hours, seven days per week, for 365 days per year
- The installation and utilisation of building management systems.

### Water consumption

By 2012, the water consumption at the University of Pretoria was at 0.66 kL/year/m<sup>2</sup>. By 2016, this figure had increased to 1.13 kL/year/m<sup>2</sup>. Through a rigorous programme of initiatives to curtail water consumption and to contain leaks, the consumption was down to 0.99 kL/year/m<sup>2</sup> by 2018. This represents a decrease of more than 12% over a five-year period.

Actions taken to reduce the water consumption included:

- A water consumption awareness campaign
- Monitoring of leak flow resulting in the replacement of water infrastructure on most of the campuses
- Meter replacements and new installations using new technology and additional meters
- A project protocol was implemented which included technical insight into renovation, upgrades, and new builds
- The introduction of a standard specification for sanitaryware.

### Reporting on UP's carbon footprint

The Department introduced an annual carbon footprint report for the University in 2015. The report typically reflects on all the sustainability initiatives undertaken in the Department ranging from reductions in energy and water consumption to the significant recycling efforts of the University, and the fact that the University is fully self-sufficient in compost and mulch production for use on its campuses.

### Renewable energy solutions

Negotiations commenced in 2017 for the installation of solar panels on the roofs of certain buildings on the University's campuses. The project entailed the signing of a power purchase agreement with a service provider who

conducted feasibility studies on all the campuses. The first two installations were done on the Merensky Library and the Technical Services Building, both situated on the Hatfield Campus. The University was able to procure electricity from the service provider for the first time by November 2017. The installation of renewable energy solutions has become an ongoing project for the Department.

### Major capital expansion projects

Numerous capital projects were executed during the period 2009 to 2018. The funding received for these projects came from various sources. Many of the projects were funded through IEG funding received from the DHET, quite a few projects were executed with funding received from other external parties (including industry partners and donors) and many funded from the University's own resources. At the Prinshof and Onderstepoort Campuses various projects were also funded — in some instances fully funded, through the National Skills Fund and the Clinical Training Grant but in others co-funded by the University. The information provided per campus and project, groups funding categories and indicates, in brackets, the date of project inception as well as the budget allowed for a particular project.

### Deferred maintenance

In 2009, the University made an amount of R42,4m available to be spent on deferred maintenance over a period of three years. Various projects were undertaken across all campuses. However, by 2013 the deferred maintenance backlog at the University was estimated to be approximately R1b. As part of the IEG4 funding, an amount of R82m was made available to the University to attend to deferred maintenance — this was co-funded by the University to the amount of R79m. The allocation of funds to attend to deferred maintenance continued in the IEG5 allocations with R42m being awarded to the University and co-funded by the University to an amount of R24.6m.

### Ongoing projects

#### Universal access

The regulations pertaining to universal access have had severe implications for the University. Although the University continued to ensure that all new projects comply with these regulations and made funding available to address the

accessibility of existing buildings, the audit conducted in 2013/2014 on all properties owned by the University showed that much still had to be done to improve accessibility. In 2014, the estimate for all UP buildings to comply with the then latest guidelines regarding universal access was R565 million, as per the report submitted to the DHET. Improving universal access is ongoing with funding made available on an annual basis. An amount of R19 million was spent from 2009 to 2018 to improve universal access. However, it should be noted that all refurbishment projects made provision for compliance with the universal access regulations, which was over and above the amount spent on smaller projects.

In 2014, a project of particular significance was the conversion of a part of the Old Chemistry Building to accommodate the Disability Unit of the Department of Student Affairs. It included the creation of a special space for students who make use of guide dogs to rest in a secluded spot outside the building. The budget for the project was R2,4 million. Previously, as part of IEG3, an amount of R2,8 million was allocated for the procurement of specialised equipment for the Unit.

Other important projects included the installation of a tactile walkway on the Hatfield Campus and the upgrading of residence accommodation for students with disabilities, as was done at Xyata Residence.

#### Fire detection and protection

Fire detection and protection remained a focus area during the review period. Not only was an annual amount set aside for these activities, but all projects undertaken also needed to comply with the latest regulations. Specific projects for improving fire detection and protection since 2009 amounted to more than R50 million. Of this, R15,4 million was allocated as part of the IEG4 funding.

#### Standby generators

The need for standby power increased from 2008 onwards when the national power grid began failing and load-shedding was introduced. By 2009, 43 generators had been installed across all campuses of the University. The installation of back-up power has become a standard feature of all projects. By the end of 2018, another 20 machines had been installed with an additional 15 in various stages of planning and construction.

### CCTV upgrade

The University has one of the largest closed-circuit television installations in South Africa. A project was approved in 2017 for the replacement of the original installation. The project was not completed by the end of 2018, but an amount of R29 million was allocated for its completion.

### Access control

In 2015, a decision was taken to replace the physical access control system used on all campuses of the University. The Impro System was selected as the preferred platform. An amount of R47 million was allocated and the project was successfully completed in 2018.

### Social learning spaces

The transformation of teaching and learning spaces is an ongoing initiative of the Department. The purpose of these spaces is to support the way in which students learn. The facilities are developed to enhance specific pedagogy, student experience, and mimic real-world work and social environments that can foster interactions and cross-disciplinary problem solving. Implementation occurs through ongoing planning and engagement initiatives, small scale interventions and is a focus for all major construction projects.

Projects undertaken during the period under review included the creation of a postgraduate hub for the Faculty of Economic and Management Sciences, notably the conversion of existing space to include a social learning space; a postgraduate hub and flexible teaching venue for the Department of Statistics; the refurbishment of a social learning space and flexible lecturing venue for the Department of Mathematics; the creation of a postgraduate hub for the Department of Consumer and Food Sciences; and the conversion of the foyers in the Theology Building into social learning spaces.

### Conservation management plan

In 2018, a project was launched to compile a conservation management plan for the University. The need for such a plan arose from the fact that the property portfolio of the University included almost 300 buildings protected by the National Heritage Resources Act (Act No. 25 of 1999). The Act stipulates that general maintenance on such buildings may not be performed without a heritage permit issued by the Provincial Heritage Resources Agency-Gauteng (PHRA-G).

<sup>3</sup> Heating, ventilation, and air-conditioning (HVAC).

The solution was to apply for a Conservation Management Plan (CMP) permit for each campus of the University. Such a permit is valid for ten years and affords the University the opportunity to plan and execute maintenance, restoration work, and minor alterations within the framework provided by the permit. A heritage architect was duly appointed to compile the plan.

The expected completion date for the project was the end of 2021.

### Major projects not yet completed

The planning and construction of a number of major projects commenced before the end of the period under review. The projects were due for completion in 2019 and 2020. The projects included:

- The Future Africa Campus built with own funds (2014, R403 million)
- The Javett-UP Art Centre (2012, R354 million) partially sponsored by the Javett Foundation
- The Engineering 4.0 facility on the Hillcrest Campus (2017, R246 million) co-funded by SANRAL
- Refurbishment and extension of the AE du Toit lecture venues on the Hatfield Campus (2017, R62 million) from own funds.

Two major projects required bulk infrastructure upgrades prior to their construction — Future Africa and Engineering 4.0, both located on the Hillcrest Campus Experimental Farm. An amount of R30 million was made available in 2016 to enable the development of Future Africa. Similarly, the construction of the Engineering 4.0 facility required bulk infrastructure upgrades to the value of R21 million. The funding was made available in 2018. While both these projects commenced during the review period, Future Africa was officially launched in March 2019 and Engineering 4.0 in November 2020.

### Acquisition of properties

During the period under review, many property transactions were concluded by the Department on behalf of the University. The following were major transactions:



- The transfer of the Groenkloof Campus to the University of Pretoria was in process throughout the period under review. By the end of 2018, it had not yet materialised and was only concluded in 2019.
- Negotiations with the City of Tshwane Metropolitan Municipality for the exchange of the Hammanskraal Campus for a property in Hatfield adjacent to the Hillcrest Campus commenced in the late 2000s. The land-swap agreement was signed by the Vice-Chancellor and Principal and the Executive Mayor in 2014. The transfer finally took place in 2018.
- The Nedhill Building in Jan Shoba Street was acquired by the University in 2011 for R60 million. The refurbishment amounted to R12 million whereafter, Enterprises UP became the tenant in the building. It was subsequently renamed the Enterprises Building.

### Awards

The University of Pretoria is well-known for its pristine campuses. The Division of Campus Services received numerous awards from the South African Landscaping Institute (SALI) during the period under review:

The Hartebeestspruit Rehabilitation Project also won an international certification known as the Ecocert for the category, Biodiversity Area. At the time of the award, it made UP the first university in the world to have part of its grounds named an Ecocert Biodiversity Area.

At the Higher Education Facilities Management Association (HEFMA) conference in 2017, the University received yet another award: the HEFMA Sustainability Award for the compost yard, in recognition of the initiative to turn green waste into organic food. Similarly, at the 2018 HEFMA conference, the University received an award for sustainable renewable energy initiatives.

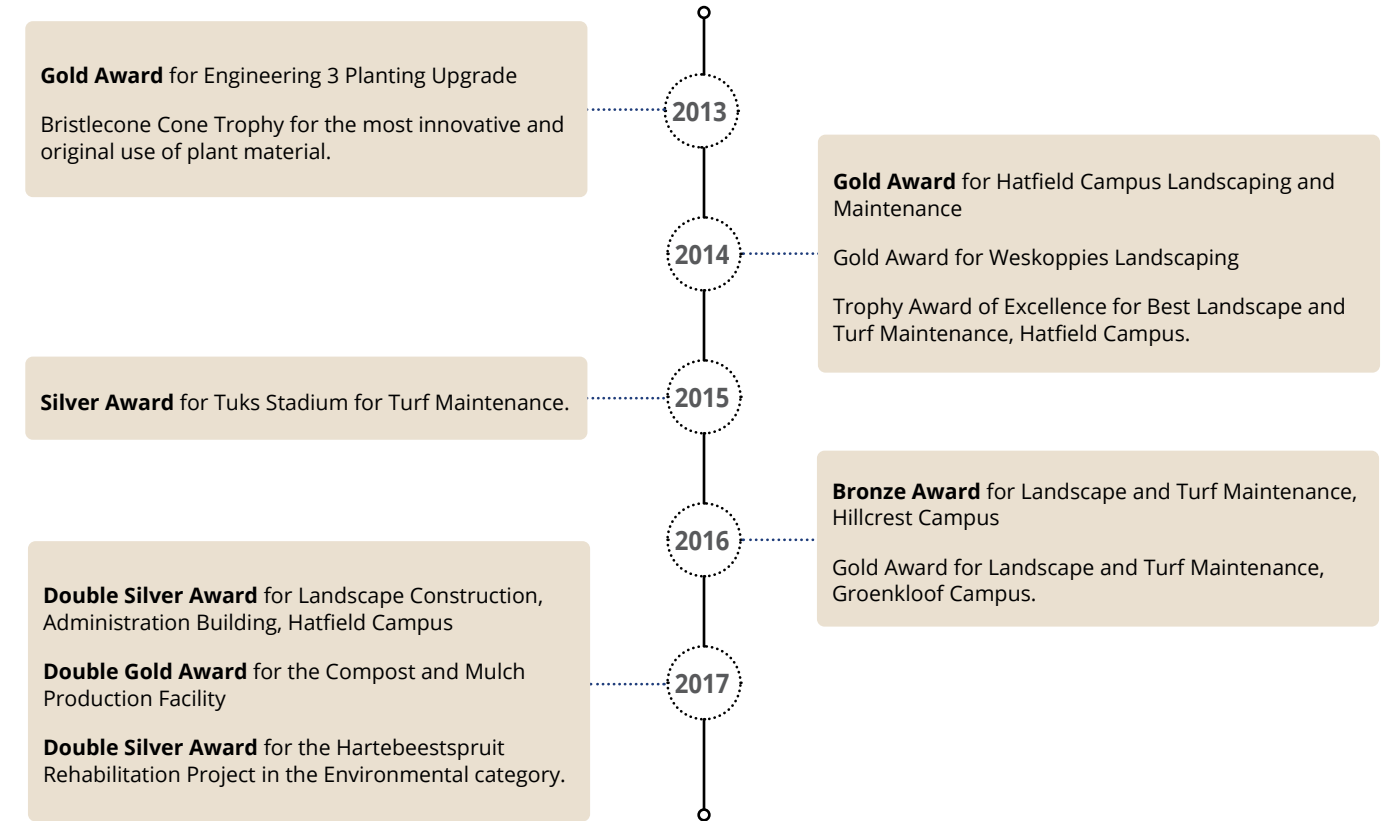

## 6 | Finance

During the period under review, the University of Pretoria's Department of Finance provided financial management, enterprise planning, and stewardship in support of the education, research, and the strategic goals of the University.

The Department remained responsible for financial planning and the management of its investment portfolios.

The Department also provided professional support to a variety of clients, including the parent and student community (served by the divisions of Student Accounts, Student Finance, and Residence Finance); the staff complement (served by the divisions of Salaries, Assets and Insurance Management, Investment Management, Budget Planning, and Procurement); and academic support service departments (served by the divisions of Budget Control and Creditors Administration); as well as the general business community (served by Creditors Administration and the Procurement Division).

In terms of the University's Management Model approved by Council in 2008, professional service departments had to develop and maintain a five-year strategic plan based on the University's institutional strategic plan, supported by other institutional plans. The Department of Finance's plan formed

the basis of an annual professional service plan, which set out the objectives and plans for a particular financial year. Three important elements of the annual professional service plan were service level agreements or offerings, specific goals for the year, as well as the strategic direction of the Department. Collectively, these specified the outputs of the Department planned for a particular year.

The Department of Finance was involved in ensuring the University's financial sustainability, challenged by events beyond the control of the University such as the #FeesMustFall campaign during the period 2015 to 2017, and insufficient increases in state subsidies. During 2015, the University was under severe pressure to insource previously outsourced services including security, maintenance, gardening and landscaping, and food services. The University took the decision to insource these services from 2016 and align remuneration and benefits over a three-year period, ending 2018.

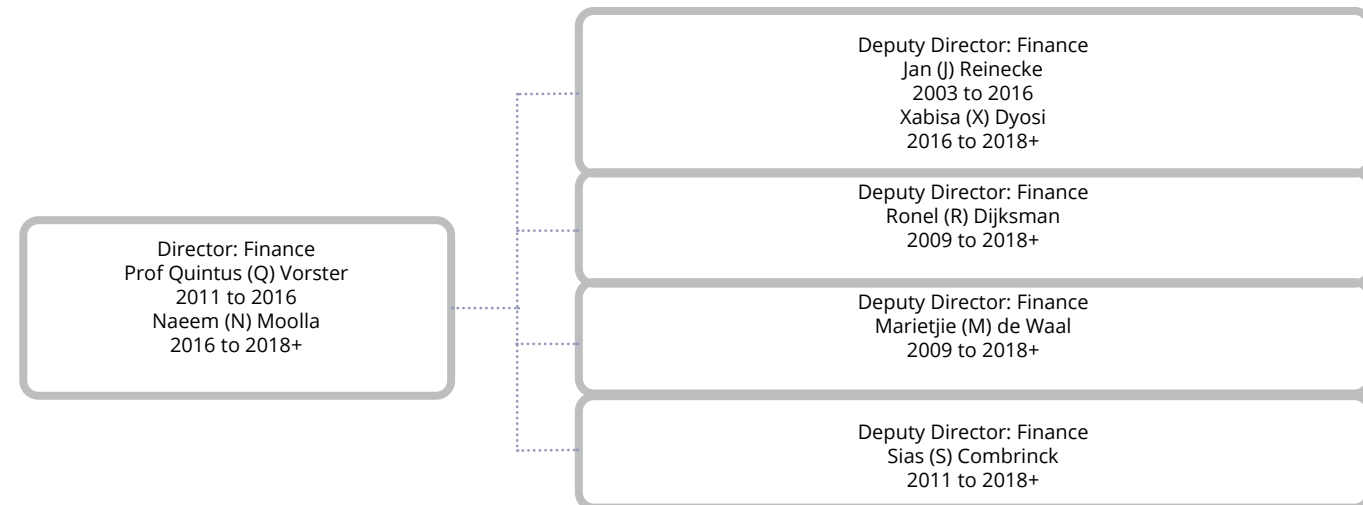

Structure of the Department of Finance from 2009 to 2018

Prof Quintus Vorster, Director Finance, 2011–2016 | Naeem Moolla, Director Finance, 2016–



### Structure and functioning

Throughout the period under review, the Executive Director: Finance, Prof Carolina (C) Koornhof, had the executive line management responsibility of the Department under her portfolio. Due to the impending retirement of Prof Quintus (Q) Vorster as Director in 2016, the University appointed Naeem (N) Moolla as Director Designate in 2016 to take over from Prof Vorster, thereby facilitating a smooth transition.

As illustrated in the figure (left), operational functioning of the Department was the responsibility of the Director, Naeem Moolla from 2016. He was supported by four deputy directors with different areas of oversight:

- Deputy Director: Finance, responsible for Student Accounts, Investment Management, Student Finance, and Salaries — Ronel (R) Dijkman
- Deputy Director: Finance, responsible for Budget Control, Payroll Planning, and Financial Systems — Marietjie (M) de Waal

- Deputy Director: Finance, responsible for Creditors, Asset Management, Insurance Management, Management Information, and Reporting — Sias (S) Combrinck
- Deputy Director: Finance, responsible for Debtors, External Funds, Procurement, and Residence Finance — Xabisa (X) Dyosi.

Jan (J) Reinecke, who was Deputy Director: Finance, responsible for Salaries, Asset Management, Creditors, and Insurance Management, retired on 31 January 2016. In light of working smarter by using technology and critically analysing current processes to identify inefficiencies, the position was not subsequently filled, and his areas of responsibility were allocated between the four deputy directors as named above.

At the end of the period under review, the Department was supported by twelve divisional heads: Ayanda (A) Simelane, Student Accounts; Herman (H) Botha, Investment Management; Marie (M) Oosthuizen, Student Finance; Cheizette (C) Lekota, Salaries; Adele (A) Truscott and Riaaz (R) Dockrat, Budget Control; Irum (I) Ebrahim, Creditors Administration; Marius (M) le Roux, Insurance Management; Christo (C) van den Heever, Asset Management; Joyce (J)

Awuah, Debtors; Ansuya (A) Govender and Phethedi (P) Molekoa, External Funds; and Paul (P) Asrie, Procurement.

### Financial systems

The PeopleSoft™ implementation project, which formally commenced in April 2008, had, by the end of 2009, deployed a subset of financial modules such as the general ledger, eProcurement, purchasing and accounts payable, billing and accounts receivable, and asset management. This included a substantial data conversion of assets as well as all general ledger transactions since 2008. Significant progress was made in the review period, with the following modules deployed:

- Inventory management
- Travel and expense claim management
- Project and programme management
- Management of research and other third-stream income contracts
- Maintenance management.

### Investment management

During the period under review, the day-to-day management of the University's investment portfolio was under the care of Herman (H) Botha.

The University's investments were overseen by the Investment Committee of Council, a body that considered investment portfolios and made investment decisions.

A multi-manager approach to the management of investments was followed to limit investment risk. In order to achieve optimal diversification of the investment risk, the portfolio managers invested a portion of the available funds abroad. The Committee did sterling work, and the market value of investments, including cash, grew from R4,543b in 2009 to R11,157b in 2018 (245% growth), while reserves grew from R6,139b in 2009 to R14,514b in 2018 (236%).

The University completed the following major infrastructure projects during the period 2009–2018:

- Engineering 3 — total cost of R256m of which UP contributed R86m. The remaining R170m was funded by the DHET.
- Future Africa — total cost of R403m funded by UP.

- Cricket SA Centre of Excellence — total cost of R25m, completely funded by Cricket SA.

It is important to note that the University annually transferred amounts from income to an investment reserve fund in order to protect its capital in the unlikely event that the market value of its investments should fall below cost. On 31 December 2018, the investment reserve fund amounted to R1,038 billion.

### Operating income

The University derived its income from a number of sources between 2009 and 2018. These included government subsidies, tuition fees, and third-stream income. The latter covered a multitude of sources, and included income from investments, donations and grants, contract research and consulting, continuing education, and the rental of facilities. The University established a comprehensive and successful structure of campus companies, which also contributed to its income.

During the period under review, UP's consolidated income increased from R3,796b in 2009 to R7,044b in 2018, an increase of 185%. The state subsidy increased from R1,256b in 2009 to R2,489b in 2018.

In addition to the funding that flowed to institutions of higher education through the funding framework (the block grant) during the reporting cycle, the Minister of Higher Education and Training also made a significant amount of funding available to institutions on an ad hoc basis, from which the University benefitted significantly.

During the period under review, the subsidy stabilisation fund had been used to counteract the negative implications of declines in subsidy. By 31 December 2018, the fund amounted to R297,3m.

The turnover of the campus entities was R383m in 2018.

### Tuition fees and related matters

The provision and maintenance of resources required for high-quality teaching and research is a challenging task, which inevitably exerts pressure on existing human and physical resources with far-reaching financial implications. The following trends that characterised the period 2009 to 2018 confirm this pressure:

- A significant change in the profile of the student community
- The demand for fee-free higher education in South Africa
- Limited increases in tuition fees (no increase in 2016 and lower than CPI increases subsequently)
- The number of contact students increased from 41 751 in 2009 to 49 730 in 2018.

Tuition and accommodation fee income made up 35% of the total income in 2018 (in 2009, 31%).

Since the 2016 presidential announcement on no fee increases, there has been an annual system-wide compact on tuition fee increases in the university sector. In 2017 and 2018, tuition fee increases were capped at 8%. It should be noted that the Department of Finance aligned tuition and accommodation fee increases to the compact set by the DHET. The average percentage increase in student fees over the period 2009 to 2018 is illustrated in Table 5.1.

The affordability of study plays a critical role in students' access to tertiary education. In 2018, the average annual university undergraduate tuition fee amounted to R44,400 and the average annual accommodation fee (including provision of meals taken in a residence dining hall) amounted to R58,900 bringing the total cost to R103,300 for fees and boarding in residences. This amount excludes the cost of related study expenses such as travel, textbooks and study material.

Throughout the period under review, the Department of Finance at UP had been successful in limiting the percentage of outstanding student fees for registered students at the end of each academic year to an average of 12% of the fees levied.

Major factors contributing to the University's ability to do so were an increase in the financial aid provided to students by the University, the state's contribution in the form of the National Student Financial Aid Scheme (NSFAS) support, and the contribution of donors, government departments, and the private sector.

### Financial aid

The University supported a large number of students through scholarships and loans. A comparison of the scholarship and loan awards issued in 2009 and 2018 indicates the expansion of this support. This is illustrated in Tables 5.2 and 5.3.

In 2018, the University provided financial aid to students to the amount of over R1,329b, representing 33 549 awards. This is an overall increase of 13% in comparison to the financial aid provided in the previous year, which amounted to almost R1,169b. Of these awards, 20% were made to white students and 80% to black students (undergraduate and postgraduate).

The University was strongly focused on promoting research-driven postgraduate studies. The University's allocation of almost R22,6m for postgraduate scholarships in 2009, reflects a 77% increase in comparison to just over R40,2m for 2018.

Financial aid covered 56% of the total tuition and accommodation fees in 2018, compared to 54% in 2017.

### Strategic funds

Severe pressure on the main sources of the University's income (government subsidy and tuition fees) compelled UP to establish, in addition to the Principal's Fund, Centenary Endowment Fund and Diversity Fund, a Human Capital Development Fund with an initial contribution of R385m. This Fund was used to appoint highly rated academics, thereby enhancing the University's research standing.

In addition to this R385m, the University supplemented the Centenary Endowment Fund with R120m, the returns (80%) on which were used to fund strategic initiatives.

The total of R505m was financed by the Investment Reserve Fund (R230m) and surpluses on the Medical Fund (R200m), and the Interest Equalisation Fund (R75m).

### Financial planning

Throughout the period under review, the Department of Finance was successful in the execution of its strategic plan, and the University's operating expenditure was maintained within the boundaries of the approved budget. Unqualified audit reports were received, and small surpluses were generated, which were mainly reserved for capital replacements, deferred maintenance, and to finance part of the University's employment equity initiatives.

By the end of the period under review, the Department had a sufficient number of well-qualified and experienced academic staff and the necessary financial systems to manage an enterprise of this magnitude.

Table 5.1. Percentage increase in student fees between 2009 and 2018

YEAR	2009	2010	2011	2012	2013	2014	2015	2016	2017	2018
% increase	9.0%	8,5%	8,0%	9,5%	9,0%	9,5%	9,5%	0%	8%	8%

Table 5.2. Scholarship and loan awards for 2009

	UNDERGRADUATE		POSTGRADUATE		GRAND TOTAL		
	white	black*	white	black*	white	black*	total
	R'000	R'000	R'000	R'000	R'000	R'000	R'000
<b>Total</b>	105 267	258 734	50 611	98 846	155 878	357 580	513 458
<b>Racial composition</b>	29%	71%	34%	66%	30%	70%	100%

Table 5.3. Scholarship and loan awards for 2018

	UNDERGRADUATE		POSTGRADUATE		GRAND TOTAL		
	white	black*	white	black*	white	black*	total
	R'000	R'000	R'000	R'000	R'000	R'000	R'000
<b>Total</b>	178 381	865 876	85 373	199 677	263 754	1 065 552	1 329 306
<b>Racial composition</b>	17%	83%	30%	70%	20%	80%	100%

\* 'black' includes African, Indian and coloured students.



## 7 | Human Resources

During the period under review, the Department of Human Resources (HR) continued to strengthen its support of the University's strategic goals and core functions. At the start of the period, HR's strategic drivers were underpinned by a set of strategic objectives for its three-year strategic plan, 2008 to 2011:

- Objective 1. Improved enablement for attracting and retaining an excellent workforce that is diverse and increasingly representative of the economically active population at all levels.
- Objective 2. Drive the development of a superior workforce, at all levels, through transformation initiatives.
- Objective 3. Deliver flexible HR services of high quality to clients.
- Objective 4. Aligned and compliant HR operations in achieving sustainable goals and aims in support of the UP Strategic Plan.

A measurable set of process improvements, having commenced in 2008 during the previous review period, were designed to improve the efficiency, accuracy, and risk minimisation of the above objectives. From 2009 to 2018, these would find expression in the following themes:

- Repositioning and restructuring of the HR Department
- Optimising HR information systems
- Focusing on talent management strategies
- Implementing the institutional transformation journey
- Managing the requirements related to insourcing.

In 2009, and again in 2017, the HR Department went through a repositioning and restructuring exercise to align and optimise its support services.

### Structure and leadership

There were several leadership changes during the period under review. Prof Annél (A) van Aswegen was HR Director from 2004 to 2013, when she was seconded to the Office of the Vice-Chancellor and Principal. Prof Karel (KJ) Stanz acted in this leadership capacity until the appointment of Reena (R) Budree in April 2014. She remained in this position until March 2016. Allen (A) Pasco was appointed as Acting Director until the appointment of Sovashni (S) Hefele in August 2018.

Between 2009 and 2015, the departmental structure comprised a director, two administrative assistants, four deputy directors and two assistant directors. The functions were grouped into the following portfolios:

- **Organisational Development** — Francois (LF) Vorster, Deputy Director (January 2004 to March 2015)
- **Human Resource Planning** — Cello (CI) Gardner, Deputy Director (December 2007 to February 2014)
- **Employment Equity** — Christine (CA) Williams, Assistant Director (April 2003 to March 2010); Ronnie (R) Nemaston, Specialist (December 2010 to December 2018)
- **Human Resource Information Management** — Paul (PD) Krige, Deputy Director (September 2007 to February 2014)
- **Employee Relations** — Moses (MM) Lekgela, Assistant Director (2009 to August 2014); Bongani (BM) Hlophe (June to September 2015)
- **HR Services** — Dr Karin (K) Franzsen, Deputy Director (April 2009 to June 2013).

The foundations laid during this period addressed a number of structural and capacity issues. By 2016, the new structure and operating model developed focused on decentralised support to faculties, effective work distribution, team-based approaches to service delivery, and greater accountability. The result was a reconfiguration, in 2017, of the divisions into the following:

The HR Director was supported by five deputy directors, with a new deputy director position created for the division of Remuneration, Benefits and Organisational Design.

The revised structure remained in place until December 2018.



Prof Annél van Aswegen, Director Human Resources, 2004–2013



**Partnerships and Services** — Francois Vorster (April 2015 to January 2019)

**Remuneration, Benefits and Organisational Design** — Vadhashnee (V) Kisten (January 2016+)

**Strategic Portfolios** — Cello Gardner (December 2007 to February 2014); Brinton (BM) Spies (January 2015 to July 2016); Dr Louw (LS) Botha (January 2018+)

**HR Systems and Quality Enhancement** — Paul Krige (March 2014 to September 2016)

**Employment Relations and Wellness** — Makgabo (MP) Sekobelo (January 2016+).

## Automation

Following the installation of the new PeopleSoft™ HR system in November 2009, the period that followed, focused on improving productivity and, at the same time, aligning HR processes with institutional policies and creating consistent operations across different functions, faculties and departments.

The implementation of the PeopleSoft™ e-recruitment module in 2010 resulted in an improved and simplified recruitment process and enabled the building of an integrated database of potential applicants from designated groups. At the same time, online onboarding as well as online terminations were enabled. More automation was achieved through the enhancement and extension of the employee and manager self-service functions, and by adding more functionalities, including changes to bank details, beneficiary details, and viewing rights of individual salary package information. On the management side, additional dashboards were implemented to give managers access to remuneration-related information.

Although automation was successfully achieved at a number of levels, remaining obstacles included aspects of the operating context, multiple layers of decision-making, and people's resistance to change. A departmental risk committee was established to monitor, review, and report on the risks affecting the HR Department and the HR strategic plan.

## Achievement highlights

There were several notable achievements during this period, including the following:

- In 2010, a salary benchmarking exercise by an external consultant was completed based on market surveys related to scarcity payments to scarce career groups, and recommendations made to review the then remuneration framework and policy in 2011.
- The exit management process was reviewed, and a redesigned exit interview process was implemented in 2012.
- An institutional project aimed at refining the Performance Management and Personal Development Management systems was undertaken by an external consultant in 2011, with recommendations implemented in 2012.

- Initiatives during 2017 and 2018 to redesign the orientation and onboarding processes required training and induction from all HR portfolios.
- A review of remuneration policy, procedures and market aligned salary scales in 2018 resulted in a new approved policy at the end of 2018 that was scheduled for implementation in January 2019.
- Also in 2018, the newly appointed Healthcare and Medical Aid Administrators, Alexander Forbes, provided the Executive with an in-depth market review of medical aid schemes. In addition to the BestMed medical scheme, the University launched a more affordable option, Umvuzo Health, in the latter part of 2018.

Revision of the major HR policies and procedures to align with the new structures, processes, and system and to meet institutional needs progressed to the point, by the end of 2018, of undertaking the required consultation or negotiations (where conditions of service are affected) with recognised unions.

## Talent management strategies

Leadership development for staff continued to be a priority, with the following leadership development initiatives prioritised:

- The UP Leadership Programme presented at the Gordon Institute of Business Science (GIBS) and follow-up courses
- The Higher Education Leadership and Management (HELM) programme for senior members of staff, a university-wide programme of Universities South Africa (USAf)
- The executive leadership programme of Higher Education Resource Services — South Africa (HERS-SA) for senior female staff
- The UP Management Development Programme.

From 2012, several strategic initiatives were prioritised to support the human capital development project in critical areas. Funding from the University's Centenary Endowment Fund was allocated specifically to drive and implement strategic human capital development initiatives:

- The Vice-Chancellor's Postdoctoral Fellowship bursaries.
- The Academic Development Grant Programme aimed at supporting permanent UP academic staff registered for

doctoral studies or master's degrees to complete their theses or degree studies.

- The Humanities research capacity project, funded by the Andrew W Mellon Foundation, to support early career academics and postgraduate (particularly doctoral) students.
- The DHET's Research Development Grant for substitution for academic staff members, allowing them to work towards completing their PhD qualifications.
- The South African Executive Leadership Programme in Health (SAELPH), led by UP's Faculty of Health Sciences in partnership with the national Department of Health, to enhance current health management capacity at the executive leadership level.
- Recurring budget provision was made for various initiatives managed by the HR Department, which included attracting and retaining staff, especially in scarce skills areas, and rewarding exceptional academic achievers and NRF-rated researchers.

## Employment Equity (EE)

An Action Plan to accelerate the pace of achieving staff diversity and EE goals and targets was implemented from the beginning of 2010.

The establishment of a Human Capital Development Fund enabled, inter alia, initiatives for accelerating employment equity, including the strategic appointment and placement of qualifying candidates to enhance UP's academic equity profile by:

- Implementing an 'order of preference' for candidates from designated groups for all new appointments, and vacant posts earmarked and advertised exclusively for filling by black candidates in faculties, departments or divisions
- Arranging preferential interviews for identified black candidates
- Making strategic appointments in posts created to achieve employment equity
- Monitoring of new appointments by the then Executive Director: Human Capital and Transformation.

Several initiatives were implemented to equip UP leaders and managers to manage transformation, covering all levels of leadership and management.

There were a number of additional measures to enhance UP's diversity profile. The DHET's New Generation of Academics Programme (nGAP), aimed at developing the next generation of academic scholars, was implemented from 2015 onwards. UP matched the funding made available by the DHET and, by 2018, 13 appointments had been made.

A Mentorship for Black Women Academics Programme, funded by the National Research Foundation (NRF), was implemented by UP's Department of Research and Innovation (DRI). Twenty-two black female academics participated in the programme in the first year, and 11 mentors were identified in the first phase of implementation. Mentees were paired with experienced academics who work in similar disciplinary fields to ensure the best possible mentorship and guidance.

### The insourcing process

In January 2016, following an unprotected strike, the UP Executive, contracted workers (who provided outsourced services), student groupings and labour representatives,



Patience Mushungwa, Executive Director: Human Capital and Transformation

reached an agreement for the insourcing of contract workers who provided services for the University in the departments of Campus Services, Security Services, Maintenance Services, and Food Services.

This process changed the University's collective labour landscape. In addition to the existing labour unions recognised by the University (University of Pretoria Workers' Organisation (UPWO), the National Education, Health and Allied Workers' Union (NEHAWU) and Solidarity, the Academic and Professional Staff Association of the Universities of South Africa (APSA) was granted the right to organise and operate at the University of Pretoria. The insourcing process took place over a two-year period, from 2016 to 2018.

The process involved the onboarding of the insourced staff members via orientation and induction processes and the realignment of the organisational structures. The latter applied to the Division of Food Services in the Department of Residence Affairs and Accommodation, and to the departments of Security Services and Facilities Management. Line managers worked with HR on the implementation and onboarding processes and assisted in the formulation of job descriptions.

In 2017, the University of Pretoria Bargaining Forum (UPBF) was created as a formal platform for engagement between the University and organised labour. A constitution was adopted and the Forum was formally constituted.

Harmonising the conditions of insourced staff was guided by a legally binding agreement. The joint Harmonisation Forum (JHF) and the Joint Harmonisation Task Team (JHTT), which includes labour union representation, were constituted to support the UPBF in finalising the harmonisation process. As per an agreement with labour, the University implemented adjustments to the midpoint of the revised salary scales for eligible staff, as benchmarked in the comparative study commissioned by the University.

## 8 | Information Technology Services

The University's commitment to sustainability permeates all aspects of institutional life and naturally extends to its information and communication technologies (ICTs). It is the University's aim to ensure that its ICT systems are abreast of international developments, to address the needs related to the Fourth Industrial Revolution (4IR) and beyond, as well as to deploy ICT as a strategic resource for the University's scientific work, its management of knowledge, in interacting with students and staff, and for the efficient administration of the University.

### Structure and functioning

Coinciding with the first five-year plan of the University's long-term strategy, UP 2025, 2012 saw a restructuring of the Information Technology Services (ITS) Department.

In May 2016, the University appointed the new IT Director, Xolani (X) Hadebe. The incumbent IT Director at the time, Dr Jakkie (JA) Pretorius, was tasked at the executive level, after a brief handover period, to look after business continuity before retiring at the end of 2017.

### IT systems, architecture, infrastructure

#### Systems Renewal Project, continued

In order to support the objectives, set out in UP 2025, and the first five-year plan, ITS needed to increase its capabilities for scaled usage as a result of increased student numbers amidst UP's ongoing and expected growth. ITS also needed to be available as a key support service, competent in its capacities to support the University's core functions. For staff and students alike, ITS aimed to create a favourable user experience by industry standard in reliability and efficiency.

By the end of 2009, UP's Systems Renewal Project had already delivered its first set of IT systems and capabilities, as envisaged by the institution's renewal strategy. This strategy originally envisaged:

- Replacing the University's legacy financial, human resources, student, and customer relationship management systems with purchased applications, through a phased approach
- Installation of a modern suite of data and systems integration tools

- New access/identity management technologies
- New portal and website tools
- New functionality supporting both document management and imaging
- New business intelligence management tools.

In the period between 2014 and 2018, a host of enhancements and new complementary systems were deployed. These included:

- Researcher ORCID integration and South African Identity Federation (SAFIRE)
- NSFAS allocation to students
- HR onboarding of all categories of staff
- Redesign (in 2017) of the look and feel of the UP Portal
- Credit card payment system expanded to include other business units e.g., TuksSport.

#### Building projects with a plan

In a pioneering step for public South African universities, the architecture function was established during the restructuring process in 2012. The Director looked after business architecture, while information architecture was addressed in a part-time capacity, and a person was appointed to drive the technology architecture. A governance structure was put in place that comprised of the Enterprise Architecture Review Board (EARB), the Enterprise Architecture Forum and a set of architecture principles. Technology investigations were structured. A practice of annual reviews of technology roadmaps for all technologies used, was followed. The discipline of applying a 'project start' architecture for every IT project was introduced and matured.

Dr Jakkie Pretorius, ITS Director 2001–2016 | Xolani Hadebe, Director 2016–



### Migrating to the cloud

The University completed the migration of over 27 000 active staff and student email accounts from a local, hosted environment to the Google Cloud solution platform shaped by the Google Higher Education initiative. This move to a respectable cloud service provider allowed the University to reap the rewards and benefits of the Google Workspace for Education initiative with an array of cloud-based services available to UP for future development and configuration purposes. This project was delivered within scope, budget and on-time in 2018.

### Knowledge management

#### Protecting research capital

During the review period, ITS continued promoting research activities while maintaining a secure environment using a balanced approach to cyber security. The University maintained a multidisciplinary team that actively reviewed UP's threat landscape, responded to cyber security events, and promoted security awareness among staff and students, while being as unintrusive or restrictive as possible in daily activities.

### Increasing access to Wi-Fi

An increasing number of students were making use of their personal computing devices to complete academic work or access the internet and other UP systems through the Wi-Fi network, including the eduroam global Wi-Fi network. The expansion in use of personal devices further led to the establishment of a dedicated student laptop support service in 2015, servicing more than 25 000 students by 2018.

The University of Pretoria appointed a service provider to provide multifunction devices (MFDs), empowering students on all campuses with advanced functions to print, copy and scan documents. This also involved a single-solution print billing system to replace the previous Phonet and P-counter billing systems. This combined multifunction printing and management system for UP students — called TuksPrint — allowed students to upload documents from any device and release their printout at a printing station of their choice.



## Teaching and learning

In the same period, ITS underpinned the University's commitment to assuring high-quality teaching and learning experiences to its staff and students by using a combination of enterprise-grade server and network technologies and carrier-grade security technologies. Staff and students on campus were supported by high-availability server and network infrastructure and their traffic was secured by next generation firewalls. Remote access was facilitated by secure Virtual Private Network (VPN) access. ITS maintained high levels of visibility in the network traffic traversing its systems to further secure all user experiences.

## Supporting UP's academic mission

The Unit for Academic IT (UAIT) was established within ITS in 2014. The formation of this unit marked a distinct shift in focus towards providing quality IT services to support the University's academic enterprise, namely research, teaching and learning, and student computing.

The UAIT was instrumental in the establishment of the High-Performance Computing (HPC) Steering Committee in 2017, which aims to coordinate and govern HPC activities at UP. On the Research Data Management (RDM) front, the UAIT became a key stakeholder and led the successful implementation of the open access repository during 2018.

ITS, through the UAIT, continued the drive to optimise the use of technology in lecture venues and student computer laboratories in order to improve the teaching and learning experience. Audio-visual support in approximately 400 lecture venues became a critical service offering and was provided by a dedicated team within ITS. Student Computing Services maintained around 7 000 computers in student computer laboratories and within libraries spread over all campuses.

During the period under review, additional student computing facilities were built on the Hatfield, Groenkloof, Onderstepoort, Mamelodi and Prinshof campuses. By 2018, each campus hosted a dedicated computer-based testing facility.

Of particular importance was the Mining Industry Study Centre completed in 2013, which incorporated a range of state-of-the-art technologies to support teaching and learning in the School of Engineering.

Student Computing Services was incorporated into the newly formed UAIT to improve the ITS support to teaching and learning across the University. At the end of the review period, over 2 million visits were recorded at the computer facilities each year and the ITS personnel were proud to have provided more than 800 students with the opportunity to gain practical work experience and work readiness for employment upon completion of their studies.

ITS introduced an online platform, called 'Votenet eBallot', to manage and administer SRC elections, allowing students to cast their vote using their mobile devices or personal computers. It was introduced in 2017 and ran successfully well beyond the period under review.

ITS introduced an end-to-end management solution in 2018 called Endpoint, for managing UP Technology assets used by staff on the UP corporate network which was running Microsoft Windows. The system allowed ITS to take both a hardware and software inventory, and to manage deployment and security of Windows devices.

Looking towards the future and aiming to maintain high availability, ITS planned a hardware refresh programme as well as the expansion of data centre services to include a secondary data centre and disaster recovery site on the Hillcrest and Groenkloof campuses.

# 9 | Institutional Planning

Established in July 2013, the Department of Institutional Planning (DIP) brought together erstwhile stand-alone units, namely the Bureau for Institutional Research and Planning (BIRAP), the Market Research Unit (MRU), the Unit for Academic Planning (UAP) and the Quality Unit (QU). Under the leadership of Dr Gerald (GW) Ouma, appointed as Director: Institutional Planning in 2013, the Department expanded its scope of work to include strategic and operational interventions and, importantly, to build a robust data-driven system to inform strategic and evidence-based planning and decision-making at the University of Pretoria.

The specific roles of the Department were:

- Strategic planning
- Enrolment planning
- Provision and analysis of data for effective decision-making
- Monitoring and evaluation
- Institutional research, including surveys
- Rankings analysis and submissions
- Academic planning
- Coordination of the University's Programme Qualification Mix (PQM)
- Managing quality reviews and accreditation visits, and
- Coordination of risk management.

During this period, the scope of the Department's functions expanded considerably. In 2014, risk management was assigned to the Department, and in 2018, the University's rankings strategy became an additional responsibility, given the increasing focus on world ranking systems nationally and indeed globally. In the same year, the functions of the erstwhile Strategy Execution Office were transferred to DIP.

Prior to 2013, BIRAP, MRU and UAP reported to Prof Antony (AP) Melck, Executive Director: Institutional Planning, while the QPU reported to Prof Niek (N) Grové, the Registrar. Following the merger in 2013, and Prof Melck's retirement at the end of 2013, the new Department of Institutional Planning reported first to Prof Tyrone (TB) Pretorius, Vice-Principal: Academic (2014), and from August 2014, to Prof Anton (A) Ströh, Executive Director: Institutional Planning.

The heads of the respective units before the merger were:

- BIRAP — Hugo (HJ) Mouton (<2009–2013)
- MRU — (C) Carlien Nell (<2009–2013)
- Unit for Academic Planning — Dr Sanette (S) Boshoff (<2009–2018+)
- Quality Unit — Christa (C) North (<2009–2012).

These leadership positions largely remained the same following the merger, except for Christa North who resigned towards the end of 2012.

## Structure and change

The merger of the units that constitute DIP resulted in a divisional structure made up of three units, namely BIRAP, UAP and QU. The MRU was incorporated into BIRAP. Each unit was led by a Unit Head who reported to the Director, as captured in the organogram below.

In 2017, a number of changes were introduced to the structure of DIP, the most prominent being the creation of three divisions within BIRAP with each division led by a senior manager:

- Business Intelligence — Carolyn (C) Kriel
- Market Research — Carlien (C) Nell
- Institutional Analytics — Gerliza (GE) Vogler.

The Division of Business Intelligence is responsible for the regulatory compliance component of the student HEMIS submission and high-level summary reports on students; the UP fact book and related reports required for strategic decision-making. The Market Research Division is responsible

for all institutional surveys while the Division for Institutional Analytics is responsible for all institutional research projects, modelling, statistical analysis, planning support and managing data warehouse development and maintenance for informed and evidence-based decision-making.

In 2018, further restructuring of DIP was proposed, which mainly related to the replacement of the divisional structure with a functional process-driven team structure, the merger of UAP and QU into Academic Planning and Quality (APQ), the renaming of BIRAP to Institutional Research and Analytics (IRA), and the replacement of the position of Unit Head with that of Deputy Director. The proposal to merge UAP and QU into one functional area was informed by the need to ensure that quality management at UP is integrated and seamless, and to ensure the optimal use of the existing capacity in the two units. These restructuring (see organogram on page 459) proposals were implemented in 2019.

**Key achievements**

The Department achieved significant success during the period under review. Key among these were the following:

**Strategic planning**

A key achievement for the Department was the development of the University's long-term strategic plan, UP 2025. This plan provides the roadmap and navigational markers for guiding the University to achieving the vision and strategic goals it has set itself up to 2025 and is supported by five-year and one-year implementation plans. Whilst the Plan was developed before the establishment of DIP, BIRAP played a leading role in its development from 2010 to 2011. Subsequent to the development of UP 2025, the Department was responsible for the development of five-year and annual implementation plans in a 'nested' approach to planning adopted by UP. The



Prof Gerald Ouma, Director Institutional Planning, 2013–



annual implementation plans are derived from a review of the previous year's performance and emerging priorities.

Thus, every year, the University's planning process prioritises the activities and initiatives to be undertaken, which activities are reshaped, and which current activities are discontinued. Annual institutional plans are complemented by annual faculty plans as well as plans of professional service departments. In addition to preparing institutional plans and coordinating planning across the University, DIP also provides an assessment of the University's performance and that of faculties and departments, develops planning guidelines for faculties and professional service departments, supports the setting of performance targets for the University and faculties and departments, develops key performance indicators. In 2017, for example, DIP developed guidelines for formulating composite indicators for professional service departments.

Another key planning achievement was the development of enrolment plans, viz. the 2011–2013 enrolment plan and the 2014–2019 enrolment plan. These plans, in essence, ensured that the 'shape and size' of UP were aligned with the University's strategic goals. In addition, the enrolment plans positioned the University in a differentiated higher education landscape, ensuring that the University, inter alia, contributes to the high level (and scarce) skills needed for economic growth and development and achieves recognition for its research in addressing some of the major challenges facing South Africa, Africa and the world.

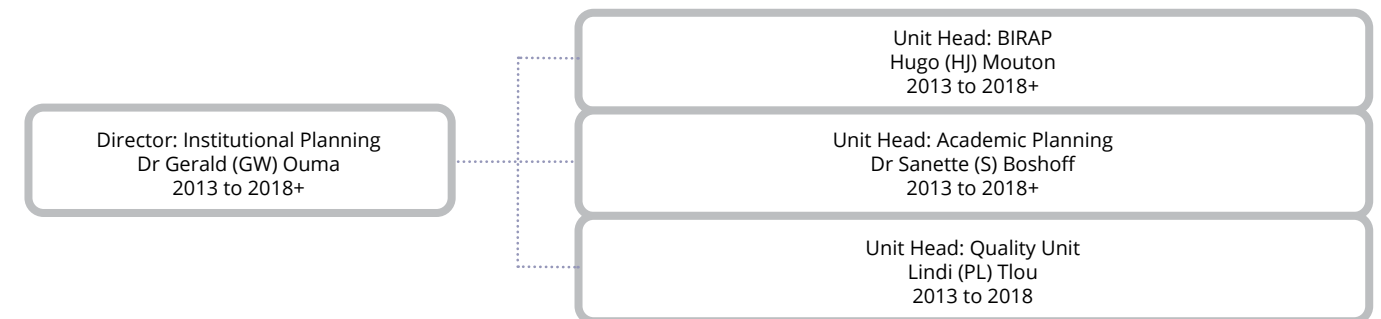

Structure of the Department of Institutional Planning, 2013 to 2018+



A new structure proposed, 2019+

## Decision support

The data and analyses provided by DIP support the University's evidence-driven approach to decision-making and strategic planning. This support includes the analysis of the policy environment and trends in the university sector, and has shaped key decisions, strategies and interventions at UP relating to, inter alia:

- Annual admission and registration targets. These targets were informed by the University's enrolment plan (shape and size) and strategic goals, realisation rate analyses which show the percentage of admitted students who register and enrolment patterns across all programmes, and analysis of the National Senior Certificate (NSC) examination results. Surveys conducted by the Department have shown that students admitted for their first-choice programmes are more likely to register compared to those admitted for their third-choice programmes, for example.
- Student success initiatives, including the FLY@UP initiative which started in 2016. These initiatives were supported by throughput, cohort and graduation analyses, the identification of students at risk and modules with low pass rates, the analysis of examination results, student retention surveys, first-year students' experience, performance in undergraduate study programmes with high credit loads, among other analyses. Through graduate destination surveys, DIP provided feedback on the employment status of UP graduates, their skills and competencies and the effectiveness of the University's work readiness initiatives.
- The New University Language Policy. Analyses by DIP of the language profile (home language, preferred language of communication, etc.) of the University's students, and of undergraduate modules by language of delivery, among several other analyses, contributed to the development of the University's new language policy, which was approved in 2016. The analyses showed that, inter alia, the number of Afrikaans home language students had declined from 77.1% in 1994 to 28.8% in 2016. Similarly, the proportion of Afrikaans home language students who preferred to be taught in Afrikaans had also declined significantly — from 77.1% in 2010 to 45.3% in 2016.

## A new management information system

DIP introduced a new management information system in 2016. The new system was a key driver for the

institutionalisation of a data and evidence-driven culture at the University. The new system also helped the Department to enhance the accuracy, completeness, reliability and validity of data and enabled managers at the University to access essential information efficiently and faster than before, and to be in a position to make informed decisions. In addition, the new system strengthened the Department's ability to conduct a wide range of analyses that are critical for decision support.

The configuration and functionalities of the new system align with the University's data needs. It provides, for example, tools that enable a comprehensive analysis of various stages of student academic progress, including current status and historical trends relating to student admissions, registrations and throughputs, cohort analyses, and reporting and tracking of performance against key performance indicators.

## Quality assurance and enhancement

Key achievements with regard to quality assurance included the implementation of various types of external reviews, inter alia, themed reviews and cluster reviews; the establishment of the Academic Planning Committee (APC) Sub-Committee which strengthened the oversight for quality assurance at the University, and the revitalisation of processes for monitoring the implementation of improvements identified through evaluations, reviews, and accreditations.

Unlike departmental evaluations that focus on a single entity, cluster evaluations, which were introduced in 2013, involve several academic entities, either within the same faculty, an entire faculty or across faculties, including the research units, centres, institutes and bureaus within these entities. These evaluations are geared at, inter alia, encouraging greater intra-cluster collaboration on aspects such as inter-, multi- and transdisciplinary research, supervision of postgraduate students, programmes, and curriculum development.

Cluster reviews have had several positive outcomes, among them, the establishment of the School of the Arts in 2018 in the Faculty of Humanities and the merger of a number of departments in the Faculty of Natural and Agricultural Sciences (NAS). This included the merger of the departments of Consumer Science and Food Science in 2017 to form the Department of Consumer and Food Science; and the merger of the departments of Biochemistry, Genetics, Microbiology and Plant Pathology in 2018 to become the Department of Biochemistry, Genetics and Microbiology (BGM).

## Alignment with the Higher Education Qualifications Sub-Framework (HEQSF)

The University's HEQSF-aligned Programme and Qualification Mix (PQM) was approved by the Minister of Higher Education and Training in 2016. Alignment with HEQSF requirements necessitated the revision of the structure of a number of programmes. This included the discontinuation or rationalisation of modules, updating the content of modules and changing the prerequisites for, as well as credits of, modules and/or programmes.

The alignment of the University's qualifications and programmes with the requirements of the HEQSF has had several positive outcomes, the most significant being the consolidation of its broad 'more than 1 000 programme-based' PQM into a focused 'less than 100 qualification-based' PQM, which is aligned with the University's UP 2025 Strategic Plan.

## Academic Planning Committee

The main purpose of the Academic Planning Committee (APC), which was established in 1987, is to provide an academic forum for consideration and approval of key academic planning and development matters relating to new academic programmes or changes to existing academic programmes. The APC supports Senate in rigorously integrating academic planning and quality assurance into teaching and learning, research and community engagement.

During the period under review, APC was chaired by the Vice-Chancellor and Principal. Its membership includes all members of the Executive, Deans and the Directors of relevant professional service departments. DIP is the secretariat for APC.

Examples of issues discussed by APC include:

- Introduction of new academic programmes and changes to existing programmes
- Academic policies
- Quality reviews
- Approval of improvement plans submitted by faculties and professional service departments following external evaluations and accreditation visits

- Institutional research reports such as realisation rate analyses, examination reports, graduate destination surveys, and employer surveys
- National policies.

In 2014, the University established the Sub-Committee of APC with the mandate to:

- Coordinate and facilitate quality assurance activities at an institutional level and ensure an institutional approach to quality assurance arrangements
- Approve self-evaluation reports before submission to review panels
- Approve the external evaluation panel members
- Evaluate the outcomes of external reviews, accreditation visits by professional councils, subject reviews by the Council on Higher Education (CHE), and institutional audits, and to ensure that appropriate action is taken
- Monitor the implementation of improvement plans resulting from external evaluations and to ensure that they are reported on annually during the consideration of plans for faculties and support service departments
- Identify trends arising from the external evaluation findings and recommend action aligned with the University's Strategic Plan and Quality Policy
- Review guidelines, procedures and policies related to quality assurance activities and recommend procedural or policy changes
- Prepare the University for institutional reviews.

The Sub-Committee plays a crucial role in closing the loop in monitoring and reviewing the quality assurance process of programmes, units, departments and faculties. It is accountable to the APC, which is a committee of Senate, and finally, to Senate.

From 2014–2018, the Sub-Committee was chaired by the Vice-Principal: Institutional Planning and its membership included the Vice-Principal: Academic, one Dean as a standing member, the Dean of the Faculty under review and the Director: Institutional Planning. DIP serves as the secretariat of the Sub-Committee.

## 10 | Internal Audit

The Department of Internal Audit is an independent service within the University that reports to the Audit, IT and Risk Management Committee of Council, a governance structure appointed in terms of the Higher Education Act, 1997 (Act No. 101 of 1997) and the Statute of the University of Pretoria.

### Structure and functioning

The Department was restructured in January 2015, following the retirement of the previous Director, Prof Maynard (M) van der Merwe, in December 2014. The name of the Department was then changed to the Unit for Internal Audit and was led by Olga (O) Granova-Mooi, Head: Internal Audit.

The Unit retained its functional reporting to the Audit, IT and Risk Management Committee of Council, while the administrative reporting line changed to the Registrar, Prof Niek (N) Grové and Prof Caroline (CMA) Nicholson after him. The Risk Management portfolio was reassigned to the Department of Institutional Planning to allow for the independence of Internal Audit.

At the end of the period under review, Internal Audit and Compliance Services employed six permanent staff members:

- Head, Olga Granova-Mooi
- Senior Management Assistant, Dalene (D) van Dalen
- Internal Audit Managers, Carin (C) Erasmus and Maggie (M) Moleko
- Junior Internal Auditors, Nonhlanhla (N) Zulu and Mlungisi (M) Lukhele.

### Focus and strategy

Internal auditing is designed to add value and to improve the governance processes of the University and its entities.

The Department consists of a highly qualified team of multidisciplinary professionals, embodying the professional values and competencies of the represented professional bodies, namely the Institute of Internal Auditors (IIA), the Association of Certified Fraud Examiners (ACFE), the Ethics Institute (TEI), the Institute of Directors (IoD), and the South African Institute of Chartered Accountants (SAICA).

During the period under review, the Unit provided comprehensive internal audits, forensic investigations, and advisory services for a wide range of projects.

The internal audit function is unrestricted in its scope, and by performing audit reviews and an array of advisory services, focuses on the evaluation of the strategic, operational and management processes of the University. The emphasis has always been on improving academic compliance and maintaining an ethical and efficient organisational culture.

An annual Internal Audit Plan is presented to, and approved by, the Audit, IT and Risk Committee of Council at its last meeting of each year. This plan details the internal control, compliance, performance, IT, financial, and value for money reviews planned for the next year.

In addition, the Unit also assists the University with a wide range of ad hoc audit and advisory services throughout the year.

The Unit administers the UP Fraud and Whistle-Blowing Register on behalf of the Office of the Registrar, and provides services relating to investigations of whistle-blowing complaints. On average, 40 to 50 new complaints were received and investigated on an annual basis during the period under review.

Advisory services relating to strategic processes, such as business continuity planning and workplace ethics management, also formed part of the duties of the Unit.

In addition, the Unit presented anti-fraud and ethics awareness training to faculties and professional service departments to raise awareness and assist staff members in complying with the regulations of the University and relevant legislation. It is envisaged that this training will in future, become part of the compulsory onboarding process for new staff members as well as all line managers, heads of department, and cost centre managers.

Olga Granova-Mooi, Head of Internal Audit and Compliance Services, 2014–



### Partnerships

The Unit for Internal Audit provides internal audit services to the University, with the support of a co-sourced internal audit service provider. A formal tender process is followed for the appointment of the co-sourced internal audit services provider. During the period under review, the co-sourced services providers were KPMG Services Ltd and Business Innovations Group (BIG).

In addition, Internal Audit and Compliance Services has over the years also partnered with the Department of Auditing, in the Faculty of Economic and Management Sciences (EMS), to provide an in-service training internship for UP students studying towards a BCom Hons (Internal Auditing) degree. Staff have also presented guest lectures to both undergraduate and postgraduate students and have participated in panel assessments of student project presentations.



## 11 | Library Services

The strategic plans of the Department of Library Services (DLS), earlier known as UP Libraries, as conceptualised over the period under review, highlighted the centrality of its goal to be a leading research library in Africa. In achieving this goal, DLS would support the vision of the University and contribute to the library profession. It also challenged itself to redefine academic librarianship in support of the University's academic project.

At the start of the review period, in 2009, Library Services had successfully implemented a client-focused strategy. The implementation of the 'Investors in People' strategy was tangible proof that the leadership of DLS was serious about being a people-centred organisation — a virtue they had hoped would persist.

In 2010, DLS developed a new vision and strategic plan for the period 2011 to 2016, with multiple strategic outcomes. Library Services would endeavour to distinguish itself as a global leader in academic librarianship, which concerned itself with the enhancement of the University's research-intensive identity. By 2018, this new vision was well-established.



Robert Moropa, Director Library Services, 2009–2018



### Leadership and strategy

Robert (R) Moropa served as the Director of Library Services during the period under review. Under his leadership, the enhancement of library services in support of research and research dissemination was a primary focus. He was initially supported by three and, from 2012, four deputy directors with portfolios realigned:

- Hilda (HAJ) Kriel (2004–2018), Client Services and Operations — the portfolio changed to Product Enablement and Shared Services
- Dr Heila (H) Pienaar (2004–2018), e-Information Strategy and e-Research Enablement — portfolio changed to Strategic Innovation
- Ujala (U) Satgoor (2008–2011), Marketing, Fundraising, Training and Quality Assurance.

Lindiwe (L) Soyizwapi joined DLS in 2012 to take up the position of Deputy Director: Client Services.

In the same year, and at the start of the implementation of UP 2025, the organisational structure of Library Services was adjusted to create space for the Staff Development and Resources portfolio, headed by Hilda Kriel. The Library IT Unit, combined with the e-Service Unit, formed the new Innovation and Technology Division under the leadership of Dr Heila Pienaar.

During the review period, the heads of support services were:

- Finances: Louis (L) Leonard (2001+)
- Marketing and Quality Assurance: Elsabé (E) Olivier (2013+)
- Library Technical Services: Marguerite (M) Nel (2017+).

The managers of the decentralised, faculty-specific libraries in 2018, were as follows:

- Faculty of Economic and Management Sciences: Brenda (B) Nsanzya (2016+)
- Faculty of Education: Julene (J) Vermeulen (2013+)
- Faculty of Health Sciences: Kableo (K) Kgarosi (2017+)
- Faculty of Humanities and Faculty of Theology: Anna (A) Siwela (2018+)
- Faculty of Law: Shirley (S) Gilmore (2005+)
- Mamelodi Library: Jacob (J) Mothutsi (2010+)
- Faculty of Natural and Agricultural Sciences and Faculty of Engineering, Built Environment, Information Technology: Suzy (S) Nyakale (2014+)
- Faculty of Veterinary Science: Susan (S) Marsh (2009+).

### Redefining academic librarianship

DLS remained cognisant of the crucial part it had to play in the University community if it was to redefine academic librarianship in relation to the creation and dissemination of research. To play this critically important role, the Department had to enable access to essential information and resources needed by researchers. Also, through their expertise, Library Services staff could assist a growing number of public researchers gain access to UP research outputs which continue to be stored and accessible in the repositories.

In essence, the resources and services that Library Services provided were a vital aid in the research produced by the University community during the period under review.

In all its endeavours, Library Services succeeded in aligning both its strategic plans and its service delivery with UP 2025:





- The vision set out by DLS involved the recognition of UP Libraries as internationally recognised spaces that placed users, staff and research development at the core of their focus.
- The Department's second strategic plan, launched in 2016, incorporated global trends in teaching and learning, research, librarianship, and information technology.
- In the following year, Library Services repositioned itself for the 21st century and chose the *Blue Ocean* strategy and the concepts of 'agility' and 'leanness' as organising principles for the repositioning.
- By 2018, DLS's focus was on the implementation of its 21st-century strategy which set out overarching strategic initiatives that would drive transformative change within Library Services.

In order to ensure effective implementation, each strategic initiative was assigned a project leader (or driver) as well as a coach from DLS's executive team. These drivers were supported by a small team, and most of the team members were selected from among Library Services' staff members. The teams were tasked with conceptualising various creative possibilities for the implementation of their respective strategic initiatives and ensuring the development and implementation of relevant products and services in this regard.

### Highlights

During the review period, there were several highlights, some of which are briefly described here as an illustration of some notable developments and achievements.

### Identity

In 2012, the centenary of the Library was celebrated. Notably, *The Merensky Story 1912–2012* was published to pay tribute to Dr Hans Merensky who, in 1937, agreed to be the anchor donor for the construction of what is now the Merensky 1 Library, thus playing a crucial role in the construction and development of an integral library space. By donating a substantial amount of money at the beginning of the fundraising campaign for this project, Dr Merensky made a momentous contribution to the foundation of the success that the Library has maintained since those early days.

### Improvement of facilities

A crucial part of the DLS's commitment to the improvement of its facilities involved the physical infrastructure available

to staff and students. Towards the end of 2010, construction on new facilities for the Merensky 2 Library commenced, co-funded by UP and the Carnegie Corporation of New York (CCNY). These new facilities would become the Research Commons and the Leadership Training Centre. The Research Commons in Merensky 2, became a dedicated space for master's and doctoral students. Refurbishment, which commenced in the previous year, also resulted in a much-improved Music Library and auditorium, and improved Reserved Collection and photocopy areas. The new Research Commons on the Groenkloof Campus, funded by the Department of Higher Education and Training (DHET), was inaugurated in early 2014. This greatly improved the research space for postgraduate students and researchers on the Groenkloof Campus.

### Library leadership centre

In 2009, DLS received a grant of US\$1 million (R8,280 million at the time) to establish a library leadership centre for the Library Information Services (LIS) profession in South Africa. Through this grant, the Department came to be viewed as being at the forefront of LIS leadership in South Africa and on the African continent. A central goal of DLS was to become a 'go-to' institution for library managers and leaders who need to strengthen their leadership skills.

Also in 2009, in line with its self-set goal of redefining academic librarianship, DLS became a member of the Research Library Consortium (RLC), a group of South African universities highly regarded in the field of research support. The members of the RLC were Rhodes University (RU), Stellenbosch University (SU), the University of Cape Town (UCT), the University of KwaZulu-Natal (UKZN), the University of the Witwatersrand (Wits), and its newest member at the time, UP. The intention of the RLC was to strengthen the research-support knowledge and skills of librarians within South Africa. Members of the RLC were beneficiaries of a CCNY grant of US\$2,5 million, which financed Phase 2 of a project that ran from 1 August 2009 to 31 July 2012. The first phase of this project had been concluded on 31 July 2009, before the DLS joined the Consortium.

### Service delivery amidst unrest

Between 2009 and 2018, the DLS conducted and participated in numerous surveys aimed at gathering data that could assist Library staff in the delivery of their services. The data collected from the surveys helped the DLS in the development of its own strategic plans, which shaped the form that Library Services took from year to year. Furthermore, the surveys often resulted in the rethinking of how DLS staff

would provide their services for intensifying and uplifting the research endeavour of UP staff and students.

The rethinking of strategy-related service delivery was most evident in 2016, when the #FeesMustFall protests caused library staff drastically to reconsider ways in which they could continue to deliver services to University staff and students alike. Because access to campuses during this time was restricted, many University services had to migrate to online spaces to make it possible for the academic year to be completed. Library Services was no different to other service or academic departments, in that the migration to a virtual service was necessitated by the sudden restricted face-to-face interaction between Library staff and students. The challenges presented to Library staff during this time highlighted the importance of e-services, ensuring that further emphasis would be placed on the delivery of DLS's e-services in the future.

### E-Resources and technological innovation

The enhancement of the Library's e-resource delivery was one of the core focus areas acted upon to remain in step with rapid technological developments.

As noted earlier, 2012 saw the Library's IT Unit collaborate with the e-Service Unit to found the Innovation and Technology Division (ITD), aimed at the improvement and implementation of e-services in the Department. The infrastructure enabled by the ITD allowed for easier access to e-resources, especially during times of crisis.

In 2015, the Library launched an investigation into replacing the Innovative Millennium Integrated Library System with OCLC WorldShare Management Services (WMS). This system was seamlessly implemented in 2016.

Library Services collaborated with UP's Information Technology Services (ITS) to ensure the seamless integration of technologies that would greatly assist the UP community in the dissemination and intensification of research and information. Further, the installation of Wi-Fi nodes in the Merensky 2 Library provided much needed internet access to students and staff. These improvements culminated in an enhancement of the services delivered to the UP community and provided e-services access to students who did not have regular access to the internet at home.

### Data management

In 2013, DLS launched a research data management project intended to create better organised capacity for data management at UP. This project further continued the development of data management in the Department, resulting in a reliable and robust infrastructure for data management and storage.

### Commitment to Open Access

In 2009, the University became the first university in Africa to adopt an Open Access institution-wide mandate.<sup>4</sup> The adoption of this mandate established UP as a university that is committed not only to the production of research, but also to unrestricted dissemination of this research via an Open Access mandate.

DLS was recognised as a leader in the area of Institutional Repositories (IR) due to its own successful repository, UPspace. In 2009, Library Services was approached by several institutions, including the International Network for the Availability of Scientific Publications (INASP), based in Oxford (UK), to provide training in IR. That Library staff were approached to provide training, highlighted the recognition achieved. Also in 2009, the Department participated in the launch of the World Digital Library project, which was initiated by the United States Library of Congress and UNESCO. This initiative aimed to make academic content available to members of the public, which included the UP academic community, at no cost.

A further illustration of the University's commitment to Open Access is the UP Law project, the *Laws of South Africa Consolidated Legislation Project*. Launched in 2013, by UP Law's Oliver R Tambo Law Library, the project aims to provide free access to national legislation so that ordinary people can readily access their legally enshrined rights. This initiative has had a direct impact on the South African public's access to and understanding of the law, thereby assisting many in ensuring that their rights are not only understood but also defended in courts of law.

### Collaboration and innovation

The MakerSpace was integral in encouraging collaboration across disciplines within the UP academic community. The Department was the first on the continent to facilitate and develop a MakerSpace facility, thereby becoming a leader in

the development of 3D print technology. Conceptualised in 2014, the project has grown year-on-year since its inception.

The year 2016, saw a heightened integration of the MakerSpace in the activities of several academic departments at UP: it proved to be a space for transdisciplinary collaboration and innovation. In 2018, the MakerSpace became the vanguard through which the Library redefined academic librarianship, expanding the possibilities of different forms that services at an academic library could take. Further, the MakerSpace laid the foundation and facilitated the incorporation of artificial intelligence (AI) into the very fabric of the products and services offered to the UP community by DLS.

### Staff development

The Staff Development and Resources portfolio was added to the Library's strategic plan in 2012, highlighting the commitment to developing both opportunities for its staff members and their skills. In 2013, DLS spent a considerable sum on staff development projects. One of these projects involved an agreement between UP and the University of Alberta (Canada) to enable staff exchange programmes, which were centred on the development and exchange of staff skills between these two institutions.

### Assessing performance

During the period under review, the Department of Institutional Planning (DIP) assessed the performance of

Library Services, along with other professional service departments, by surveying the experiences of their respective users to determine the level of user satisfaction. The data collected from these surveys indicated that the DLS had been largely successful in the pursuit of quality service delivery to the UP community; most interestingly, DLS performed better after the #FeesMustFall student protests of 2015–2016.

In 2011, and again in 2017, Library Services was reviewed by external review panels that confirmed that the Department was client-focused, technologically developed, and a national asset. The results of these reviews proved that the DLS had been successful in the goals set out in its strategic plans.

The Department also participated in the international LibQUAL survey to determine overall user satisfaction with the Library's service delivery in 2009, 2013 and again in 2017. The results showed that UP Libraries was succeeding in its goal to provide excellent and transformative services to its users.

As demonstrated by the numerous surveys that UP libraries have conducted and participated in, the goals established in the Library's strategic plans were satisfactorily achieved. User satisfaction became a core focus for Library staff, and the Library itself succeeded in maintaining a high standard of service delivery, during the review period and beyond.

Further endeavours will continue to place research intensification and user satisfaction at the forefront of library activities.



Merensky Library Research Commons, breakaway room

<sup>4</sup> An Open Access mandate is a policy adopted by a research institution (e.g., a university) that requires researchers to make their published, peer-reviewed journal and conference papers open access (e.g., freely accessible to all potential users online) by depositing their final, peer-reviewed drafts or post-prints in an open access institutional repository. <https://repository.up.ac.za>

## 12 | Research and Innovation

The Department of Research and Innovation (DRI) plays an important role in coordinating and facilitating a wide spectrum of programmes and services that support research and innovation, postgraduate education, and internationalisation at the University.

The Department had frequent changes in leadership during the period under review. Dhesighen (D) Naidoo led DRI from 2008 until 2012. He was followed by Dr Carol (C) Nonkwelo, who assumed the Director's role between 2012 and 2016. From 2016, until the end of the period under review, the Department was led by Dr Nthabiseng (N) Taole.

### Structure and strategy

In 2017, Dr Taole facilitated a restructuring of the Department, following the incorporation of several related services housed in other departments. This led to a change in the Department's name from the Department of Research and Innovation Support (DRIS) to the Department of Research and Innovation. DRI now consisted of five divisions, each of which contributed towards the realisation of the mandate of the Department, guided by UP 2025.

During this period, DRI also focused on generating third-stream income through research commercialisation and intellectual property, and transfer of technology to industry. In 2018, the divisions comprising DRI, and the respective divisional heads were:

- Research Capacity and Development — Dr Rakeshnie (R) Ramoutar-Prieschl (2018+)
- Graduate Support Hub — Dr Aceme (A) Nyika (2017+)
- Innovation and Contract Management — Adv Lawrence (L) Baloyi (2013+)
- International Cooperation — Setsipane (S) Mokoduwe (2018+)
- Systems and Operations — Melodie (M) Wheeler (2017+).

### Research capacity and development

This Division was led by Dr Patricia (P) Smit until her resignation in March 2018. Dr Rakeshnie Ramoutar-Prieschl was appointed as Head of this Division in November 2018.

The Division was restructured in 2018 into two units, to be led by managers:

- Early Career Academic Support, managed by Abe (A) Mathopa. The unit provided academic and administrative support to academic staff members and, in particular, early career academics. It also facilitated the National Research Foundation (NRF) ratings applications and awards.
- Research Grants Support, managed by Ninette (N) Kotzee. The unit focused on two primary objectives, namely to increase the number and success rate of grant applications submitted, and to increase external research funding.

### The Graduate Support Hub

The Graduate Support Hub (GSH) was established within the Department in 2014, with Dr Kwezi (K) Mzilikazi as the first head.

After the 2017, the Postgraduate Bursaries and Scholarships Unit, managed by Leanne (L) van Zyl, as well as the Postdoctoral Fellowship Programme Unit and the Postgraduate Recruitment Unit, managed by Sylvester (S) Siboto, were integrated into the GSH.

Dr Aceme Nyika was appointed as head of the GSH in 2017. In order to better support postgraduate students at UP, the GSH introduced the FlyHigher@UP programme in 2018, which provided academic, administrative, and financial support to postgraduate students to improve completion rates.

(l) Dr Carol Nonkwelo, Director Research and Innovation, 2012–2016 | (r) Dhesighen Naidoo, Director Research and Innovation, 2008–2012 | (b) Dr Nthabiseng Taole, Director Research and Innovation, 2016–2018 and beyond



Table 5.4. UP intellectual property activity from 2009 to 2018

	2009	2010	2011	2012	2013	2014	2015	2016	2017	2018	Total
New invention disclosures	9	15	6	16	21	26	10	18	17	17	155
New trademarks	1	1	0	0	1	1	2	1	0	5	12
New licences signed	1	3	2	0	0	2	1	2	2	5	18
New start-up businesses	0	0	0	1	0	0	0	2	1	0	4

### Innovation and contract management

The Innovation and Contract Management Division was created from a merger of the previous Contracts and Intellectual Property Office, and the Technology Transfer Office.

The Division was led by Advocate Lawrence Baloyi, who was appointed in 2013 to unite and manage these functions. The Division was subsequently expanded to include a new Commercialisation Office.

The Division thus consisted of the following four units:

- Technology Transfer Office, managed by Refilwe (R) Ngoato
- Research Contracts Office, managed by Dr Simon (S) Thanyani
- Commercialisation Office, managed by Thabang (T) Qumza
- Industry and International (EU) Partnerships, managed by John (J) Visagie.

In terms of UP intellectual property activity, reflected in Table 5.6, the strength of the biological sciences and bioscience-related inventions dominated the patent portfolio, followed by engineering-related inventions. Between 2009 and 2018, 155 invention disclosures were made. Four new start-up businesses were founded, 12 new trademarks registered, and 18 new licences signed.

The number of patents, both local and international, increased substantially in the latter parts of the period under review. The aggregate international and South African patents filed were 86 and 93, respectively. The aggregate numbers for international and South African patents granted were 39, and 27, respectively. There was a substantial increase in focus on international patent applications from 2014 onwards. Between 2014 and 2018, 72% of all international patents over the period under review were filed, with corresponding success.

### International cooperation

This Division was also the subject of restructuring in 2017 in order better to execute a mandate of fostering research partnerships with industry, government and international stakeholders in support of research and innovation. It also provided administrative support for all international degree students, as well as short-term international exchange and visiting students, with about 86% of those coming from the rest of the African continent.

During 2016 and 2017, the two offices supporting internationalisation at UP were merged into one division within DRI. The International Affairs Office and the International Students Office were joined within DRI, and the resulting division was named International Cooperation. Setsipane Mokuduwe was appointed as the head of this division in 2018. Louise (LMA) Euthimiou continued as the coordinator of International Relations and Wiida (W) le Roux continued as the manager of the International Students Office within the Division.

The University's focus on research partnerships in Africa is closely related to pursuing science that transcends disciplinary and institutional divides and advances the type of science

leadership needed to address key challenges in Africa. To this end, UP is a partner in a number of research consortia in Africa and contributes actively to the region's knowledge base and planned intervention strategies. Joint degrees are a result of collaboration between UP and partner universities where the candidate is awarded a prestigious single degree, jointly certified by the partner universities involved. Joint degrees for UP were explored in 2016, with the first agreements signed and four students enrolled in joint research doctorates by 2017. By 2018, there were thirteen active joint doctorate agreements.

### Systems and operations

The Systems and Operations Division was established in 2017 as part of the Department's restructuring, to ensure that the operational administration improved and that the data and information needs, which support research at UP, are better integrated into the core enterprise technology systems. Melodie Wheeler, who was transferred from the Client Service Centre to DRI in 2016 as part of the Optimising Student Services (OSS) project in 2015–2016, became the first head of this Division in 2017.

The Division subsequently provided support to the Director's office for all financial and human resource-related administration. The research outputs Department of Higher Education and Training (DHET) subsidy submission was moved into this Division. Since 2017, an increased focus on the quality of the submissions of full books and chapters in books saw a 10% increase in the rate of successful subsidy awards for this category. The research section of the UP website saw an overhaul in 2018.

In 2017, over 27 different data sets were identified as manually managed and by the end of 2018 four of these were transformed into online technology systems. These include pre-award Grant Management, Research Development Programme funding, online listing of postgraduate scholarship offers, and academics' international travel grants. At the end of the period under review, the remaining data sets were waiting for programming resources to also become fully-fledged IT systems.



# 13 | Residence Affairs and Accommodation

During the period under review, the Department of Residence Affairs and Accommodation (DRAA) focused on redefining its role. Central to this was the emphasis on being a home-away-from-home. This was in line with the Department's vision, which was to offer an on-campus listening, living, and learning environment that enhances the experiences of both staff members and students at the University.

Through this redefinition of its role, the Department sought, as its mission, to actively provide an overall conducive environment for academic success, student well-being, and contributing towards the development of graduates who will also become well-rounded citizens and future leaders.

The mission and vision of DRAA was continuously refined over the five years since its establishment as a separate department within the University. As such, Residence Affairs and Accommodation began to articulate its strategic direction and objectives more concisely, so that it saw itself as striving

towards the creation of a community that fosters academic excellence, safety and security, and personal development and growth, as well as rendering professional services. The Department furthermore committed itself to being responsive to the needs of staff and students and to be driven by the ideal of improving the quality of both staff and student life in residences.

These efforts were in line with the strategic direction of the University.



Prof Roelf Visser, Director Residence Affairs and Accommodation, 2004-2014 | Sisana Machi, Director Residence Affairs and Accommodation, 2014-2018 and beyond



- Placement Management and Guest Accommodation
- Student Support and Leadership Development
- Residence Management and Student Life
- Food Services
- Residence Systems Management
- Residence Facilities and Maintenance Management
- Residence Operations
- Finance and Administration.

## Structure and strategy

The Department previously reported to the Senior Vice-Principal, Prof Chris de Beer, and at the start of the period under review, to the Registrar, Prof Niek Grové. From mid-2013, it reported to Prof Themba (NT) Mosia, Vice-Principal: Student Affairs and Residences.

The directorship changed after the passing in 2014 of its founding Director, Prof Roelf (R) Visser. Subsequently, Sisana (S) Machi took over the reins until June 2019 when she retired. In terms of operational structure, the Department consisted of the following divisions, as illustrated in the organogram that follows:

## University residences: capacities and name changes

By the end of 2018, the University had 30 residences. Among these, one residence was newly acquired (Varsity Lodge) and one residence (Khanyisa Naledi) was discontinued for occupation by students for safety reasons relating to its location. All residences continued to be led by their respective heads of residences. This model worked well in supporting the leadership of the Department in overseeing most of the dynamics relating to the overall residence student wellness, academic support, and the enhancement of student life activities.



Residence management structure, 2009 to 2018

In 2017, the DRAA was able to consolidate the various placement policies for first-year students, senior students, and postgraduate students into the Residence Placement Policy<sup>5</sup>.

In 2018, the University undertook a transformative residence name review, which resulted in the changing of names for some residences. The entire process was student-led and student-centred. Appendix I provides an overview of the residences, according to campus clusters, and their respective capacities during the period under review.

### Public-private partnerships

The University engaged in extensive public-private partnerships, which included the leasing and accreditation of private residences to accommodate students whose residences were undergoing refurbishments, and making every effort to cater for the increasing demand for student accommodation.

The leased residences included: Urban Nest, Eastwoods Village, Hatfield Studios, The Fields, Flowers Edge, Hatfield Square and Apartments on William. The leased accommodation varied between 100 and 2 000 beds.

The accreditation process was formalised after the approval of the Policy on the Accreditation of Private off-campus Residences in 2015. The strategy of public-private partnerships enabled the Department to exceed its target of 1 700 beds for 2016 by the accreditation of over 4 500 additional beds. In 2018, more than 7 500 beds were accredited.

### #FeesMustFall campaign

#### Impact and the Department's response

In 2015, the larger student community across the country embarked on the #FeesMustFall campaign in pursuit of fee-free higher education, as they considered the cost of higher education to be unaffordable for many students.

The consequences of the Fallist movement had an impact on the overall functions and finances of institutions. The implementation of a zero percent student fee increase at that time led to severe financial constraints, on institutions and services. The DRAA is responsible for the payment of all its operational expenses and services, and following the zero percent fees increase in 2017, only received a relief grant from the Department of Higher Education and Training (DHET).

During the same period, many students could not access UP campuses due to restrictions that were put in place. However, services and operations at DRAA continued, as students remained in residences. The Department cautiously opted to open the doors of many of its residences to day students as well, especially the communal study areas and IT laboratories. This had a positive impact on day students, as they were able to access online academic activities and materials, and study for their tests and examinations.

### Achievements in supporting students

#### Student support and development

The Department managed to develop comprehensive student support, leadership and organised student life programmes, which contributed to enabling students to adjust within the residence environment. The Department also developed the TuksRes Guide, which has served as a reference document regarding residence life and student support dynamics.

A solid student development programme, which among others included annual training for over 300 newly elected House Committee members, a Women in Leadership programme, the Eldership programme (for former residence leaders who had been instrumental in assisting the Department during student training sessions), and other students who were interested in self-development opportunities. All these programmes were built around the ideal of a transformative society and contributing towards building students as well-rounded citizens and future leaders.

#### Residence refurbishment programme

As some of the University's residences had aged, the departments of Facilities Management and Residence Affairs and Accommodation embarked on a refurbishment programme to ensure that the condition of residences complies with good quality standards. Eight residences were refurbished between 2012 and 2018. Initially, the Department of Residence Affairs and Accommodation had to source funds mainly from its reserves. Later, the DHET provided some relief by contributing about half of the costs for refurbishments as part of the Infrastructure and Efficiency Grant (IEG).

#### Improving access to the internet and security

Previously, students in residences only had the option of accessing internet in the IT labs. The Department's efforts

to improve access to the internet were initially through the installation of network cables in student rooms. As internet access methods improved, the DRAA, with support from the Department of Information Technology Services (ITS), further advanced student access to the internet through Wi-Fi installation across residences. This enabled greater connectivity and internet access for different types of devices.

Wi-Fi was installed in all communal areas of residences, and the process of full Wi-Fi installation began at the end of 2018. Initial priority was given to postgraduate and postdoctoral residences, followed by undergraduate residences.

Security cameras were also installed at all residence entrances and in most communal areas, as a proactive measure to monitor residence safety and security.



# 14 | Security Services

The unique role of the Department of Security Services (DSS) is to create and maintain a safe and secure work and study environment for staff and students alike.

During the period under review, the adaptability and the tenacity of the DSS was tested probably more than ever before. In a constantly changing environment, its strategy and visibility required frequent realignment. While the University's long-term strategy, UP 2025, remained the anchor strategy, the role of Security Services was also complementary to UP initiatives such as FLY@UP and FlyHigher@UP by contributing to a safe environment in which students could thrive and excel.

## Focus and strategy

During the period under review, the Department regularly realigned its crime prevention strategies, resources and the application of its security systems, informed by risk analyses of crime tendencies and recommendations from crime reports. This alignment resulted in various initiatives which included:

- Inspection of contractors entering UP premises for valid access cards and documents
- Deployment of undercover UP security officers in areas facing an escalation of crime or hotspots
- Extension of the Green Route after-hour escorting service for students to their place of residence or vehicles to all campuses
- Establishment of the Park and Ride facilities at Hillcrest and Groenkloof Campuses
- Provision of safe parking while alleviating the parking challenge on the Hatfield Campus.

Johan Boonzaaier and Phillip Mmushi in the Operational Management Centre



Colin Fouché, Director Security Services, 2002–2017 | Johan Boonzaaier, Director Security Services, 2017–2018 and beyond



## Structure and functioning

From 2009 to March 2016, the Security Services consisted of an average of 60 permanent staff members. Colin (CC) Fouché, the Director of Security Services (2002–2017), was succeeded by Johan (JCN) Boonzaaier, a senior figure in the Department. Mr Boonzaaier, previously Deputy Director: Operations, was appointed as the Acting Director after Dr Fouché's departure in 2017.

The organogram below reflects the departmental structure, after insourcing.

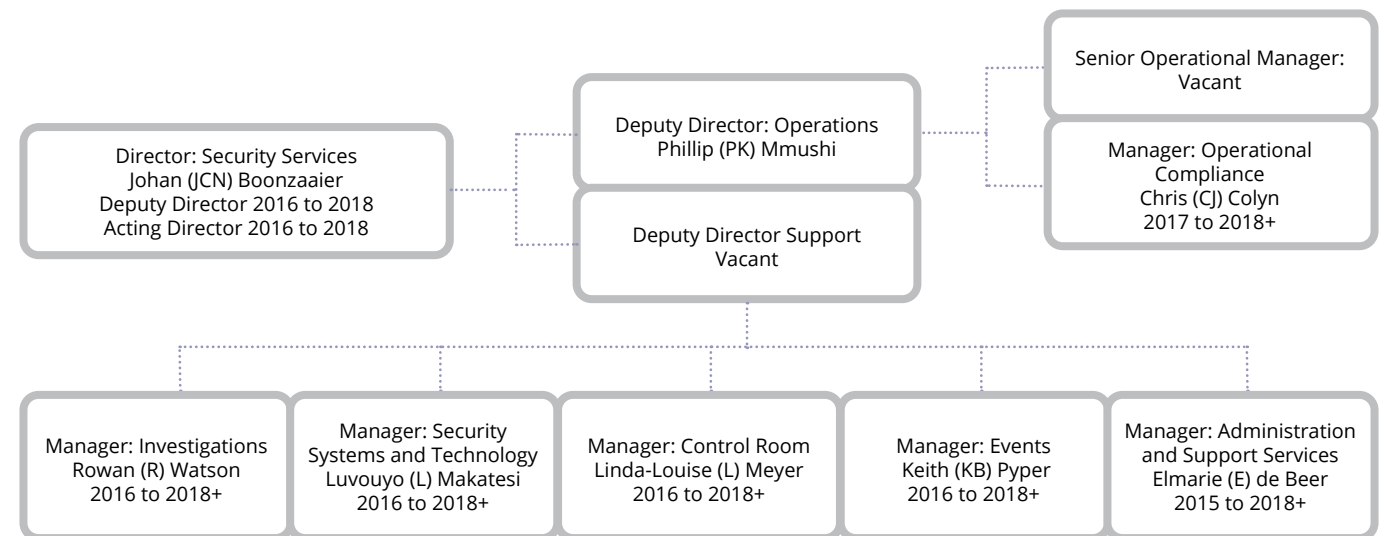

Structure of Department of Security Services from 2016 and beyond



### Collective responsibility

DSS ran regular security briefings to create awareness for new and existing students as well as for international visitors. These briefings generated awareness of taking collective responsibility for safety, and ownership of one's own safety (specifically students in residences) while studying at UP.

The focus of the awareness campaigns extended beyond safety on UP premises, including adjacent areas and amenities frequented by UP students and staff. For example, a response vehicle service was implemented in 2013 by Fidelity Security Services, which covered the area surrounding the Hatfield residences to ensure safe after-hour visits and to provide a security presence. The escalation of incidents which targeted student vehicles parked in the streets and other petty crime

incidences in the Hatfield area gave rise to the deployment of seven additional Hatfield Central Improvement District (CID) officers in the streets surrounding the main campus.

In addition to the above, joint operational actions were launched with the South African Police Service (SAPS), Tshwane Metropolitan Police Department, Hatfield CID, the UP outsourced security service provider, and staff members of DSS.

These joint operations were carried out stretching from Hatfield Campus to Groenkloof Campus to the West, and the N4 interchange at Hillcrest Campus, in an attempt to clean up those areas by removing any informal housing or structures, which incidentally led to several positive arrests of criminal elements.

The positive cooperation and support of the external partners can be ascribed to the importance that DSS places on these partnerships and the intention to foster and nurture the relationships.

Good governance is essential to the services rendered by the Department. Four new policies were drafted during the period under review and were all approved by the end of 2018. These were the Security Policy; the Access Control Policy; the Traffic and Parking Management Policy; and the Closed-Circuit Television Surveillance Policy, Procedures and Code of Conduct. Existing policies were also amended during this time, namely the Medical Emergency Policy, as well as the Gathering policies for both staff and students.

### Security services management

A tender process commenced in 2010, as the existing contract expired in 2011. The tender was awarded to Fidelity Security Services and the contract commenced in December 2011 until 2015. At that stage, the contract was extended in the light of the possible insourcing of all security contract staff, which was finalised in April 2016.

In 2017, a tender was again awarded to Fidelity Security Services for providing security service on an ad hoc basis only, due to insufficient manpower and specialised skills required for specific services.

International Medical Services was appointed in 2013 for the provision of day-to-day emergency medical services.

### Student protest

DSS's role became more prominent with the rise of the Fallist movement and its various campaigns, including #FeesMustFall and #UPRising in August and September 2015, and #OutsourcingMustFall at the beginning of 2016. These campaigns had far-reaching implications for the operations of the Department as well as its role at UP, which necessitated tactical thinking and crisis management.

A joint operational centre was established in the boardroom of Security Services during periods of unrest, fully equipped with communications infrastructure and CCTV camera surveillance systems. Representatives from SAPS, Public Order Police Services (POPS), Tshwane Metropolitan Police Department, and emergency medical services joined members of Security Services centrally to monitor and manage operations, provide feedback to the UP Executive,

and activate additional emergency services as required.

Despite various incidents of student protest actions on different campuses, the Department, in conjunction with SAPS and POPS managed these successfully. Minimal loss of or damage to property was experienced in comparison to other universities in South Africa.

### Insourcing

One of the demands during the student unrest was for outsourced services at UP to be insourced. In January 2016, UP approved the insourcing of all Fidelity Security Services employees in accordance with Section 197 of the Labour Relations Act (Act No. 66 of 1995). The existing staff complement of 65 was extended by 615 new staff members, ranging from managers and supervisors to security officers and administrative personnel. The UP Legal Division and PricewaterhouseCoopers facilitated the process and ensured due diligence was accomplished.

During the unrest, the Department of Security Services was responsible for the management of the security contract and was therefore directly impacted when the decision was made to insource all security personnel. This was arguably the largest transformation to the Department during the period under review — the management role changed from management of the contract to management of a large internal staff complement.

On 1 April 2016, DSS ensured that all new personnel were issued with UP-branded uniforms, equipment and access cards.

Initially, with this insourcing, the University entered into a temporary service level agreement (SLA) with Fidelity Security Services in terms of which it would perform only certain functions — for example, administering of the rostering and payroll as well as rental of vehicles and equipment — until such time that the University was in a position to take ownership of all related issues.

Several interventions were initiated to integrate the new staff members. A skills needs analysis was performed by the Human Resources' Learning and Development Division, and consequently training was provided for achieving computer literacy, obtaining Grade 12, learning First Aid, improving client care, creating financial awareness, and monitoring performance management, among others.



### Financial sustainability

DSS upheld and adhered to good financial practices throughout the period under review. Prior to the insourcing of staff, the Department managed to create a sustainable third-stream income through meticulous financial administration of the security contract. The contractor was penalised on a monthly basis, in accordance with the penalty clause of the SLA for poor performance and non-compliance. These recovered funds were successfully used to provide for security systems in the absence of budget allocations or to cover any budgetary deficits.

This initiative of generating additional funds was continued by providing events management services to internal and external clients.

### Events management

The safety of patrons at events hosted by UP is a key function of the Department. The Safety at Sports and Recreational Events Act (Act No. 2 of 2010) was implemented successfully at all events, from 2011. Adherence to this legislation impacted the operations of Security Services drastically.

After the establishment of the UP Events Committee in 2014, Security Services became a major role-player in coordinating the different events on campus and ensuring that regulations were adhered to at all times. Safety and security at UP corporate events — such as Graduation ceremonies, and Welcoming and Open days — were successfully managed, as were various UP sporting, religious, academic and cultural events.

Some of the larger external events managed were the 2010 FIFA World Cup, the relaunch of the Aula in 2012, the Park-and-Ride facility for viewing and paying respects to the late former president, Nelson Mandela in December 2013, and the World Choir Games in 2018.

### Electronic security systems and technology

During the first five years of the period under review, large building projects were completed by Facilities Management, which resulted in a substantial increase in the number of electronic security systems. At the beginning of 2010, electronic systems consisted of 4 531 alarm points, 996 card readers and 528 cameras. Towards the end of 2015, the installations had increased to 7 582 alarm points, 2 637 card readers and 2 468 cameras. These projects included the Engineering 3 Building and parkade, the Plant Sciences Building, TuksSport High School, the Letlotlo Building, the Mining Study Centre, and more. These systems were monitored by the 24-hour Operational Management Centre and administered by the Department's Administration and Support Services Division.

An added advantage of the ITS Systems Renewal Project in 2010, was the start and end dates of access cards, as well as default access rights which were managed by a comprehensive integration process. This eliminated the need to rely on both the manual capturing of records and the deactivation of cards upon termination or completion of studies, both of which greatly enhanced the control of access to campuses and residences. The implementation of the PeopleSoft™ Permissions Manager system to manage access of external persons intending to enter campus replaced the paper-based process and so streamlined the process of contractor applications for cards and access.

In 2012, an online parking application system, based on the business rules for parking, was implemented and fully integrated with the access control system. The existing access control system platform was no longer serving the requirements of UP in that it was not able to manage the increased number of card users effectively, combined with the initial strain that additional access points added. An investigation into upgrading or replacing the system was launched in 2014, and in 2016, the Impro Access Control System was procured, and implementation of the system began. The rollout was completed at the end of 2018. Dual verification was implemented at the perimeter of campuses and residences to include biometric scanning as an additional security measure.

## 15 | Student Affairs

During the period under review, the Department of Student Affairs (DSA) underwent significant changes. Prof McGlory (MT) Speckman headed the Department as Dean of Students from 2004 until his resignation in 2011, overseeing two divisions, namely Student Support and Student Development. The position was converted into a director's post. Dr Matete (NRM) Madiba was appointed as the first Director of DSA in 2012. Dr Willem (HW) Jorissen was appointed as Deputy Director, succeeding Prof Linda (L) Schoeman. In line with UP 2025, especially Goal 5, which is to increase access, throughput and diversity, a proposal entitled, 'Holistic Development and Student Success at UP' was submitted to, and approved by, the Executive in 2012. The proposal highlighted several gaps in the then strategic and operational focus of Student Affairs. The proposal made several recommendations and proposed a proactive and cohesive plan around holistic student development and success.



Dr Matete Madiba, Director Student Affairs 2011–2018 and beyond | Prof McGlory Speckman, Dean of Students, 2004–2011



During this time, the Department reported to the Vice-Principal: Academic and Student Affairs. The portfolio was subsequently split and a Vice-Principal: Student Affairs was established. Prof Themba (NT) Mosia was appointed in the position in 2013.

DSA prepared and underwent a process of review in 2015, facilitated by the Department of Institutional Planning. The review included panel members from the University of Cape Town (UCT), the University of Johannesburg (UJ), and the University of South Africa (Unisa).

The Department was moved from Old College House in 2011. The Student Counselling Unit was relocated to the Student

From 2012 onwards, DSA was reorganised into five units: Student Counselling, Student Health Services, Student Development, Student Governance, and the Disability Unit. The Department, with its five reorganised units, refocused on the design and development of proactive, high-impact co- and extra-curricular programmes to enhance student success and leadership, and the provision of professional services for student welfare and wellness.

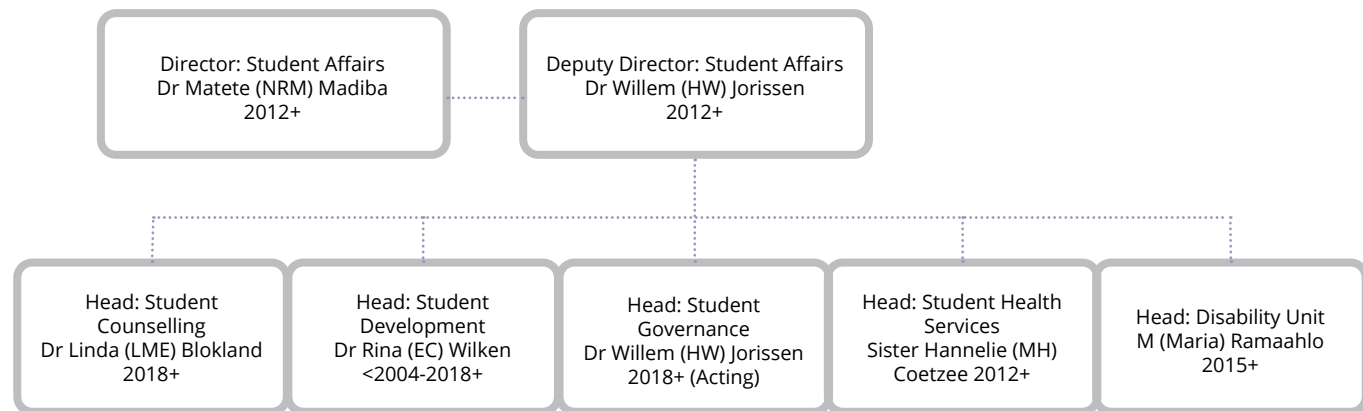

Structure of the Department of Student Affairs in 2018

Centre; the Student Development and Student Governance Units, together with the Director's office, relocated first to Tukkieurf, and later to Roosmaryn, now renamed the Student Affairs Building. The Roosmaryn Building was officially allocated to Student Affairs and Prof De la Rey unveiled the plaque on 17 October 2011. The Disability Unit relocated to a section in the Old Chemistry Building.

The organogram on page 484, shows the structure of DSA in 2018.

### Units

#### Student Counselling Unit

During the period under review, the University experienced growth in student enrolment. There were also significant changes in the student profile, with increased diversity beyond race and gender. The number of students requiring access to services provided by the Student Counselling Unit increased way beyond the available staff capacity. Dr Madeleine (M)

Nolte, who headed the Student Support Division (which was later converted into the Student Counselling Unit) retired in 2016, and Dr Maud (M) Ntanjana was appointed as head of the Unit. She was succeeded by Dr Linda (L) Blokland in 2018.

The Health Professions Council of South Africa (HPCSA) conducted a reaccreditation visit to the Unit in 2016, which resulted in the Unit being reaccredited as an internship site for the following five years. The University consequently increased the internship positions from three to seven. In 2017, an impact assessment revealed that 47% of students who used the services received personal and emotional support, 26% academic support, 23% social support, and 11% said that the support they received helped them to stay at university. The student feedback was overwhelmingly positive.

A 24/7 telephone counselling service was introduced in 2016 in collaboration with the South African Depression and Anxiety Group (SADAG). The uptake of the service has continued to increase since its inception.



SRC swearing in ceremony, 2012



### Student Health Unit

Under the coordination of Sister (Sr) Rykie (R) Venter the Student Health Unit received a merit award for excellent service during the H1N1 viral influenza epidemic of 2010. Sr Hannelie (MH) Coetzee took over after Sr Venter's retirement and was appointed as coordinator of Student Health Services in 2012. Some of the changes that were implemented from 2012 included the change from a prescribing medicine model to a dispensing model, under the supervision of a medical practitioner in all student clinics. Student Health clinics were extended to five of the UP campuses. The Student Health Unit runs a well-established health and wellness programme which covers a wide spectrum of health topics. The programme includes campaigns on sexual and reproductive health, cancer, as well as gender-based violence.

### Disability Unit

When the Disability Unit became a stand-alone division in 2012, Isaiah (I) Manele served as the coordinator, after he was

redeployed from Mamelodi Campus, where he was previously part of the Vista University staff component. He retired in June 2015 and was succeeded by Maria (M) Ramaahlo.

The Disability Unit has become a leader in higher education in terms of the provision of services for students with disabilities. Its strong human rights approach allows for equal access and participation of students with disabilities in the UP teaching and learning environment. The support of students with disabilities is complex, and the Disability Unit concerns itself with the academic, technological, and co-curricular support of students with sensory, physical, neurological, medical, and psychological disabilities. The Unit assists with the provision of the latest advances in assistive technology and equipment. In 2018, the Mamelodi Disability Unit was built with funds received from the DHET. The Unit facilitates co-curricular activities, including disability awareness training, inclusive policy development, focus group discussions, transformation seminars and work readiness programmes for students with disabilities. In 2016, the University reviewed its disability policy through an appropriate consultative process.<sup>6</sup>

<sup>6</sup> Policy on Students with Disabilities. [Rt 320/19]

### Student Development Unit

For the period under review, the Student Development Unit, under the leadership of Dr Rina (EC) Wilken, saw significant transformation and development in all areas. The Unit is responsible for organising various student structures, including their training and development. Over this period, the Unit designed and implemented a number of flagship programmes including the STARS Mentorship programme, new and reorganised programmes and events for RAG (Reach out and Give), Student Culture and Student Sport, and Enactus.

The STARS Mentorship Programme was launched in 2009 to assist first-year students in adapting to university life. Senior students were identified and trained to mentor first-years and help them adapt, socially and emotionally, to student life and to succeed in their academic performance. The programme was expanded over the years, incorporating the Residence and Student Representative Council (SRC) Mentorship Programmes from 2012.

The RAG and Student Culture and Student Sport programmes saw significant transformation to become more inclusive and responsive to the needs of the diverse student profile. Several events that were no longer viable — they had either lost their appeal or were deemed to have posed risks — were terminated. New projects, such as RAG of Hope Day, Mandela Day, and the Kagiso Programme were introduced and served to organise student voluntary community engagement. More changes were made to the format and criteria for participation in the first-years' concert and singing contests, and new culture and sport initiatives were introduced. Enactus, which was known as SIFE until 2013, launched the student entrepreneurship development programme in the form of an international competition. Teams from UP won the national competition and represented South Africa in America in 2010, and in Mexico in 2013.

The nine Faculty Houses were restructured from purely academic structures to more holistic structures in 2016, and increased their participation in student life activities. The Class Representative system is a well-established structure and a feeder into the Faculty Houses. Web-based class representative registration, training and engagement started in 2011, and was taken fully online via various digital platforms in 2018.

Several Day Houses provided active platforms for participation in student life activities. Luminous was founded in 2011, and Docendo in 2015. Zeus and Jacarandia were dissolved in 2014 and 2015 respectively. Vividus Men changed

their name to Dregeana in 2017, and Vividus Ladies changed to Vividus in 2018.

During the decade under review, *Perdeby*, the student newspaper, enlisted around 70 students as editors and journalists annually and published an astonishing 211 printed editions of the newspaper. The Editor-in-Chief, Carel (C) Willemse, developed the newspaper from a small student newspaper to a media house producing print, digital, video and online exclusive content. While *Perdeby* had an online presence from 2001, a concerted effort was made in 2011 to digitise content for online access through a new website. The first digital flip-through copy of *Perdeby* allowed readers to enjoy a digital version of their favourite student newspaper on any digital device. Between 2015 and 2017, the newspaper played a fundamental role in covering student protests sparked by the Fallist movement. It provided coverage that no other mainstream media could, and captured students' stories with context and insight that was often overlooked by other media.

The excellent work of the student journalists, led by Michal-Maré Linden (editor 2015–2016), cemented the relevance and legitimacy of *Perdeby*. The coverage also highlighted the necessity and importance of digital news, with more than a million readers visiting the *Perdeby* website and Facebook pages during this time.

In 2018, the newspaper's name changed from *Perdeby* (Afrikaans for wasp) to PDBY (an acronym for Print, Digital, and Broadcast Youth media).

### Student Governance Unit

The functioning of a legitimate Student Representative Council (SRC) as the democratically elected voice of the student body and functional leadership structures that serve the interests of the student community at large are key to stability on university campuses. The constituency-based two-tier student governance model, with a Student Assembly and a SRC, was renegotiated in 2010. After failed SRC elections in 2009 and 2012, an extensive process culminated in a new model and the more user-friendly Student Governance Constitution, which was approved by the University Council in August 2013. The new model moved away from a political party-based way of electing student leaders, to a SRC with 12 elective and seven ex officio portfolios, where individuals contested for the positions.

The Student Governance Unit oversees the Constitutional Tribunal, Student Disciplinary Advisory Panel, and the

various student societies, each of which needs to apply for registration on an annual basis. For every year during this period, registered student societies numbered over one hundred.

The University's vibrant student life continued to evolve over the decade under review. In 2015, the Vice-Principal arranged a two-day facilitated Student Life Lekgotla involving approximately 120 participants. The lekgotla resulted in the development of a new vision for student life at the University.

The national Fallist movement and attendant protests in 2015 and 2016 resulted in a disruption of SRC elections. As a result, a temporary student committee was appointed by Council for 2017. An e-voting system was introduced for SRC elections in 2017. The voter turnout reached a record high of 10 744, signifying an increase in democratic participation of the student body. Following the UP #FeesMustFall movement, broader demands for transformation resulted in engagements with and interventions by mediators (Nelson Mandela and Ahmed Kathrada Foundations), after which the DSA facilitated the establishment of the four Lekgotla

workstreams, namely, Curriculum Transformation, Language Policy, Institutional Culture, and Residence Culture. The workstreams became drivers of transformation for the institution.

Over this period, a project to formulate a well-designed curriculum for student leadership development and training ensued, with clear outcomes linked to students' development needs and profiles. The project aimed to ensure that the well-designed curriculum is, at any given moment in time, well documented and implemented using hybrid modes of delivery.

### Tuks FM

In 2011, the campus radio station, having been marred by capacity constraints for some time, was moved from Student Affairs to CE at UP<sup>7</sup>, and was restructured as a vesting trust, with UP as its only beneficiary. As a licenced community radio station, Tuks FM reached new heights under the professional guidance of CE at UP. The station underwent a full transformation in 2018.

## 16 | Transformation Office

After 1994, the University was faced with a growing need to undergo a rigorous process of change. This could be achieved by opening up opportunities to those who were previously excluded by the University's system and processes. The University began systematically to address substantive change in 2012 when it launched the *UP Journey for Change*.

This initiative was preceded by an extensive institutional culture survey in 2011. The recommendations born out of the institutional culture survey were used as contributions to develop a number of key transformation strategies and interventions, including the *Re a Bua* project, which was rolled out in 2013, and ran until 2015. The *Re a Bua Dialogue Series* provided safe spaces for staff and students to discuss the kind of transformed University they envisaged. The dialogues aimed to achieve the following objectives:

- Sharing perceptions of barriers and enablers to diversity at UP
- Understanding the benefits of lived diversity (academic and social)
- Creating a climate of improved race relations
- Understanding the negative impact of prejudice
- Creating a common understanding of employment equity and the challenges faced by UP.

Also in 2016, building on the *Re a Bua* work, the Transformation Lekgotla established workstreams focused on: language policy, curriculum transformation, and residence life and institutional culture. The Transformation Workstream on Residence Life and Institutional Culture Transformation was separated into two workstreams. The resulting Institutional Transformation Workstream on Institutional Culture was chaired by Prof Derick (D) de Jongh.

Each workstream put forward significant findings and recommendations which were used to map the future of transformation at UP. Some of the recommendations included:

- Promotion of robust dialogue on transformation among and between staff and students, using key representative bodies and control groups
- Establishment of a communication campaign around a memorable theme or slogan such as #OwnUpp, both online and on campus

- Establishment of physical social learning spaces on campus designed to promote dialogue about institutional culture transformation
- Crafting of a transformation roadmap for the institution.

Also in 2016, the UP Council appointed the Independent Transformation Panel, chaired by retired Judge Johan van der Westhuizen. The panel received submissions from and consulted with key stakeholders, and reported its findings and recommendations to Council. The panel, in its recommendations, distinguished between long- and short-term goals, which would further strengthen the transformation strategy of the University. The long-term recommendations were to:

- Review policies on student admission and financial support mechanisms so as to ensure equity
- Evaluate graduation rates and the possible impact of funding to develop better support programmes
- Evaluate and repurpose the UP brand nationally, continentally and globally.

The short-term recommendations were numerous and are not listed here, save for the two below:

- The first was to address the issue of language at UP, considered central to driving equity, diversity, and inclusion.

As a result, in 2016, a new University language policy was developed and subsequently approved by both Senate and Council. English became the sole language of instruction and assessment at the University, with the date of implementation set for 2019.

- The second recommendation was to redress the demographic profile of the University's staff and students.

This commitment was supported by the development of the University's Employment Equity Plan (EE Plan, 2016–2020), which identified the realisation of equitable representation of suitably qualified members from the designated groups as a



key priority, and the three-year Enrolment Plan (2017–2019), which sought to ensure, inter alia, a diverse student body.

### UP Transformation Plan

In August 2017, having analysed and synthesised the prior work (briefly described above) into concrete foundations, the University approved its first transformation plan, titled the UP Transformation Implementation Plan. The Plan was a strategic document for guiding mainstreaming transformation through the setting of long-, medium-, and short-term goals for the institution, and monitoring and evaluating the implementation thereof so as to facilitate progress towards their achievement. Transformation at UP, as a strategic imperative, appears as a core strategy of UP 2025 in the form of recognising the University's early beginnings and strengths in existing diversity as well as embracing diversity to enrich the University's intellectual environment and improve graduate outcomes. Thus, transformation at UP, as a strategic driver in UP 2025, continues to ensure success in teaching and learning, and research; to be a means for attracting historically disadvantaged communities; and to be a catalyst for creating the conditions in which all members of the University can thrive.

At the time of the Transformation Plan, it was accurate to say that UP had made considerable progress in the journey of change on which it had embarked in 2012. At an institutional level, and at an embedded level of planning, such as the second five-year plan (2017–2021), UP's success was recognised as being dependent on how well it values, engages and includes students, staff and stakeholders (including suppliers) from diverse backgrounds.

As captured in the five-year plan, the overarching goal of transformation was to foster and sustain a transformed, inclusive and equitable University community. This overarching goal was supported by the following sub-goals:

- Ensure access to a diverse student body, reflective of the demographic mix and social complexity of South Africa
- Significantly reduce and ultimately eliminate differential student success and graduation rates based on race, gender, class, and other critical variables
- Ensure the realisation of employment equity as set out in the University's Employment Equity Plan
- Enhance research capacity and productivity of black and women academics

- Engender institutional cultures and practices that are welcoming to students and staff from diverse socio-economic and cultural backgrounds.

The approval of the UP Language Policy in 2016 displayed a commitment from the University to instil an institutional culture anchored in respect, tolerance and unity. Structures, systems, mechanisms and processes were also put in place to eliminate and monitor any form of discrimination, harassment and violence in line with the University's anti-discrimination policy which was still in development.<sup>8</sup> This saw initiatives such as #SpeakOutUP being rolled out — a platform that created an opportunity for the UP community to engage in uncomfortable issues of transformation. The Transformation Office and the Centre for Sexuality, AIDS, and Gender (CSA&G) embarked on an initiative to roll out gender-based violence awareness trainings.

### Towards a Transformation Office

By the end of 2018, the anti-discrimination policy was proposed but not yet approved. The policy was envisioned to strengthen the implementation of the Transformation Plan. The purpose of the policy would be to prevent all forms of unfair discrimination in the University and guide the management of discrimination cases. This commitment by UP leadership would be further strengthened by the establishment of a Transformation Office, a goal which was set for 2018. A fully functioning transformation office would ensure accountability, responsibility, and concerted efforts towards implementing the strategic transformation agenda of the University. The Office's key objectives would include but not be limited to:

- Ensuring that the Transformation Strategy of the University is aligned to and implemented in line with the strategy and plan of the University
- Developing and supporting transformation strategies, implementation, and monitoring
- Contributing to all transformational change management forums within the University in order to entrench an institutional culture that values, promotes and celebrates diversity and inclusion
- Designing, managing, and implementing various social justice initiatives, advocacy, awareness, and prevention campaigns run by the Transformation Office

- Developing and implementing diversity and inclusion strategies
- Reporting on the University's transformation progress to relevant internal forums and external stakeholders such as the Department of Higher Education and Training (DHET)
- Engaging and managing internal and external stakeholders.

The Transformation Office was established in 2019.

The period under review witnessed the unfolding of an important journey comprising a foundational research

and discussion stage, which led to phased approaches of formalising transformation as part of the University's overarching institutional agenda. It also revealed that the University gained vital ground in actioning its commitment to transformation. The involvement of students and staff was key to building the future of the University and transforming the institution as they had envisaged. However, authentic transformation requires a substantive culture of inclusion.

The University had gained vital ground in actioning its commitment to transformation. The involvement of students and staff was key in building the future of the University and how they envisaged transformation.



Prof Tinyiko Maluleke, Advisor to the Vice-Chancellor and Principal, 2016–2018

## 17 | TuksSport

TuksSport, the Department responsible for sport at the University of Pretoria, strengthened its contribution, not only to university sport in South Africa, but also to sport at regional and international levels during the period under review.

Its successes were in no small measure due to the support received from the leadership of the University who understood the impact of sport on students' lives and on the identity of the University. This means that TuksSport could actively contribute to the brand and image of UP through its clubs and its achievements that spanned national, regional and international competitions.

The focus on providing a platform for competitive and recreational sport opportunities was key to the TuksSport strategy. TuksSport became home to more than 30 sporting codes through its competitive offering, while providing opportunities to thousands of UP students to compete in recreational sporting activities such as the annual internal leagues.

At a national level, TuksSport contributed to the establishment of the Varsity Cup and Varsity Sport brands, while continually ensuring UP's sport management operations were sound, to ensure long-term success within these new competitions and University Sport South Africa (USSA) tournaments.

At the level of international competition TuksSport left its imprint too, with several outstanding achievements during the review period.

### Structure and leadership

TuksSport was led by the Director, Kobus (K) van der Walt, along with two Deputy Directors, Dr Rendani (R) Mulaudzi (Deputy Director: Sport Management) and Johan (J) Potgieter (Deputy Director: Support Services).

A new deputy director role was approved during the period under review to support the sport programme's focus on contributing to national pride and national success stories. This was the focus of the Varsity Cup and Varsity Sport student competitions. These two student-based competitions would provide a high-performance component to the USSA national tournaments already on offer, while showcasing universities and their sports clubs on national television platforms.

Kobus van der Walt, Director TuksSport 1999-2018 | Toby Sutcliffe, Director TuksSport 2018 and beyond



sport science and medical support. These services, along with the Hillcrest Sport Campus sporting facilities (training and competition), provided an environment for guests and TuksSport athletes alike to witness excellence and to excel.

Among the highlights were:

- The hpc and the TuksSport facilities providing a home for the Argentinian football side during the 2010 FIFA World Cup in South Africa.
- Numerous Olympic and international athletes, along with the TuksSport stars, made use of the services on offer at TuksSport and hpc in preparation for the 2012 (London) and 2016 (Rio de Janeiro) Olympic and Paralympic Games.
- During these Games, high-performance TuksSport athletes continued to be a significant contributor to TeamSA, the Commonwealth Games (2010, 2014, 2018), the FISU World Universiade (2009, 2011, 2013, 2015, 2017), and several World Championships (senior and junior, across numerous sporting codes).
- At the 2012 and 2016 Olympic Games, athletes at TuksSport contributed to five South African Olympic medals, and a host of international medals at Commonwealth, FISU Games, and world championships.

Steven (S) Ball (Deputy Director: Coaching and Performance Management) was appointed in 2012 to focus the high-performance component of TuksSport's national endeavours. With the retirement of Johan Potgieter, Lydia (L) Monyepao was appointed in 2014 as Deputy Director: Support Services.

In February 2018, Kobus van der Walt retired as Director, having established sport as a significant part of the University's DNA. During his tenure, the performances of UP's student teams and international stars positioned the University as the premier university sport brand in South Africa. Toby (T) Sutcliffe, the CEO of the High Performance Centre (hpc) was appointed as acting Director in a dual role to achieve a greater synergy between TuksSport and hpc.

### Highlights

The hpc continued to host and provide a home to many local and international athletes and teams through its offerings which included hotel accommodation, meals, transport, and





**TuksAthletics**



HPC/TuksSport High School athletes who represented South Africa at the 2016 Olympic Games



- Under the leadership of Hettie (HH) de Villiers, the TuksSport High School, a one-of-a-kind sports school, continued to provide the necessary development platform for prospective high performers and student athletes at TuksSport. The academy provided a home to many scholars from South Africa and other countries within Africa, with these athletes representing their countries in junior national teams globally.
- Through a significant partnership with a private donor (the Athletics Foundation Trust), a new school building was constructed on the Sport Campus, providing a new home for students in 2015.
- Within the student athlete sporting context, TuksSport established itself as a significant role-player in medal winning performances. Annually, TuksSport claimed numerous USSA team titles, with more than 75% of UP teams finishing in the top three positions. Three Varsity Cup rugby titles were won in 2012, 2013 and 2016 respectively. Seventeen Varsity Sport titles were won during the period since the establishment of the competitions in 2012/2013, proving TuksSports'

dominance in student sport in South Africa and providing significant exposure to the UP brand.

The Sport Campus landscape continued to develop and expand, as substantial upgrading of facilities continued. This included (but was not limited to) new hockey astro turfs, sport clubhouses, and the installation of a new Mondo Olympic-standard athletics track in 2016. With the promotion of UP's professional soccer team, AmaTuks, the TuksStadium received a significant upgrade to ensure compliance with league and event hosting specifications.

Throughout the period under review, TuksSport, hpc, and the TuksSport High School continued to build partnerships with local government on specific projects, while developing key collaborations with various national and provincial federations, such as the Blue Bulls Rugby Union, to support performance athletes who made UP their home. These relationships, along with the drive and focus of the total TuksSport programme, its staff and athletes, ensured that UP became known as the premier sporting entity and brand in South Africa.

## 18 | University Relations

By 2018, the Department of University Relations (DUR), soon to be renamed the Department of Institutional Advancement (DIA), was a significantly changed department.

Although the core mission remained, the circumstances under which the Department operated had changed considerably. The focus was communicating the excellence of the University's academic, research, and engagement endeavours to international and local audiences. In addition, the Department had to keep pace with changing internal and external environments, and take the lead in the overall management of the University's fundraising, strategic communication, and interaction with a diverse range of audiences.

A game changer was the appointment of Prof De la Rey as Vice-Chancellor and Principal in 2009. She had direct oversight of the Department. The new leadership overhauled UP's planning cycles and tirelessly worked to achieve the international recognition and accreditation of UP's research and academic excellence which, in turn, became an important focus of DIA's operations.

The second catalyst during this period was the 2015–2016 student unrest, which required several critical adaptations. As a result of student protests, UP transitioned to online teaching, off-campus crisis management, as well as both off-campus and online ways of communicating with the University's staff, students, parents and stakeholders.

### Key foci and developments

Enhancing the performance of UP's official communication channels necessitated the development of dedicated and expert units, such as the Content Hub, which operated in a fluid environment of instant communication on social media, and the Marketing and Communication Unit, which applied the UP brand by harnessing different mechanisms to bring a vast array of messages to many internal and external stakeholders.

In 2015, the Digital Technologies Division joined the Department as the UP website was seen as one of the most important communication channels to drive reputation and to influence stakeholder perception.

A further critical development, as the Department's organisational experience increased, was hosting official corporate events that garnered a reputation of sophistication and smooth execution for DUR and indeed the University brand.

Advancement and Alumni Relations became an increasingly professional outfit dealing not only with maintaining contact with the University's nearly 300 000 alumni, but also engaging UP's alumni, friends, industry partners, and other sources to raise funds to continue producing graduates from diverse and, especially, underrepresented groups.

### Structure and leadership

Executive line management of DUR remained in the portfolio of the Vice-Chancellor and Principal when Prof De la Rey assumed office at the end of 2009. In 2017, line management moved to the executive portfolios of Prof Anton (A) Ströh, then to Prof Tinyiko (T) Maluleke, thereafter to Prof Stephanie (SG) Burton for several months in 2018, and then finally to Prof Caroline (CMA) Nicholson.



Prof Denver Hendricks, Director DUR | Prof Yolanda Jordaan, Acting Head of Department



UP Welcome Day

Prof Yolanda (Y) Jordaan acted as Head of the Department of Corporate Communication and Marketing in 2009, following the resignation of Elizabeth (E) Pretorius. When Prof Jordaan returned to her academic position in the Faculty of Economic and Management Sciences in 2011, Prof Denver (D) Hendricks was appointed as Director, a post he held until the end of 2015 when he proceeded to establish the Office of Government Relations and Special Projects (GRaSP) in the Office of the Vice-Chancellor and Principal, with a view to fill the identified gap of the University's communication with government, one of its primary stakeholders. GRaSP produced a bi-annual newsletter that was widely distributed to all three spheres of government informing them of successful, collaborative interactions between the University and government, and encouraging further joint projects.

In 2011, the Departments of Corporate Communication and Marketing, Institutional Advancement, TuksAlumni, and aspects of International Relations, were restructured and merged into the new Department of University Relations which comprised three sections:

- Corporate Communication and Marketing — general stakeholders
- Institutional Advancement — donor and sponsorship community

- TuksAlumni — UP's alumni partners.

In the same year, Linda (L) van Wyk replaced John (J) Visagie as Acting Head of Institutional Advancement. She became Deputy Director of Advancement in 2013, until the end of 2016. Hernan (H) Finkel succeeded Linda van Wyk as Deputy Director: Advancement and Alumni Relations in 2017, with the name change to this portfolio brought about in 2018.

In 2016, Reinher (R) Behrens was appointed as Acting Director. Shireen (S) Chengadu acted as Director from 2017 until mid-2018, when Rikus Delpoort was appointed as Director. Under his leadership, the Department transformed into the structure as illustrated on page 498.

### Highlights

At the start of every new academic year in January, for most of the review period, DUR and later DIA, hosted thousands of new first-year students on Welcome Day, and thousands more high school learners on Open Day at the end of May, each year. These events required immense efforts and fine coordination from faculties, service departments, and organisational capacity centred in the Department. After 2016, the nature and scope of both events were significantly downscaled.





Rikus Delport, Director of DUR/DIA (centre), and staff

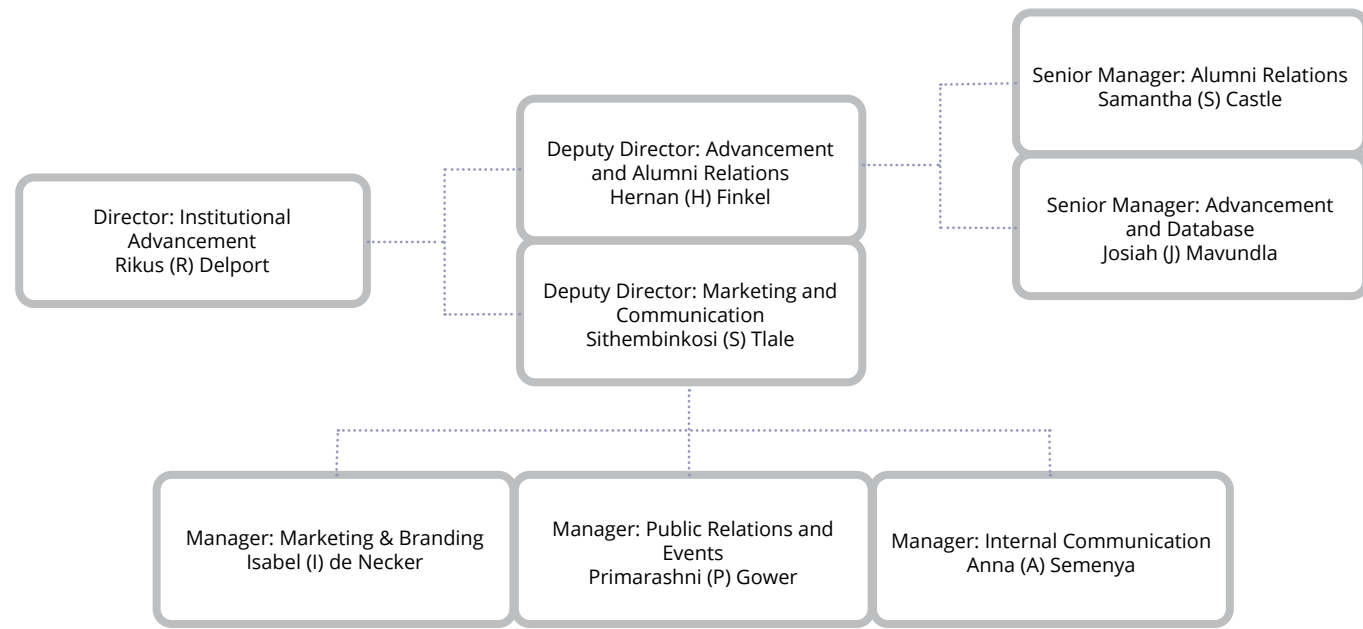

Structure of the Department of Student Affairs in 2018

The Department remained involved, during the review period, in organising and working at events when the University received members of Cabinet, the international diplomatic corps, and other dignitaries, such as former president Jacob Zuma who visited the Hatfield Campus in 2010 as a guest of the Centre for Mediation in Africa. In 2016, Bill Gates delivered the 14th Nelson Mandela Annual Lecture, which was hosted at the Mamelodi Campus.

The Advancement section in the Alumni Relations Office excelled in its engagement with ultra-high net worth donors and alumni in the period under review. In 2016, under the

leadership of Linda van Wyk, it sourced R400 million in financial aid — the highest ever at the time.

The Communication and Marketing section was responsible for the initiation, rollout, and management of numerous information and awareness campaigns. The overhauling and refreshment of the UP corporate identity and brand was a major undertaking that started in 2014/15 and continued for several years. Among many others, #ChooseUP was a major campaign founded in 2018, aimed at encouraging enrolment at UP.



President Jacob Zuma, keynote speaker at Africa Dialogue lecture series, 2010

# Looking to the future

- 1. Introduction
- 2. Centre for the Advancement of Scholarship
- 3. Forestry and Agricultural Biotechnology Research Institute
- 4. Future Africa
- 5. Javett-UP Art Centre
- 6. Engineering 4.0
- 7. Unsettling Paradigms

# 1 | Introduction

This chapter brings together a number of research institutes, centres and hubs that offer academic spaces for transdisciplinary research at the University of Pretoria. They are by and large, research platforms that are not embedded in either departments or faculties within the University. They enjoy relative autonomy from the faculty structures, even though they keep some relationship with them. These include: the Forestry and Agricultural Biotechnology Institute (FABI), the Centre for the Advancement of Scholarship (CAS), the Future Africa Institute, the Javett-UP Art Centre, and Engineering 4.0. In a traditional sense, they are positioned as institutes or centres for advanced research, which are designated to create the environment for innovative scholarship with a focus on high-level research. However, these institutes and centres offer additional research platforms, which are often free from faculty or departmental constraints to engage in inter-, multi- and transdisciplinary research and international collaborations.

Although not all the entities covered in this chapter focus on independent research, those that do not — such as the Javett-UP Art Centre — offer the much-needed ancillary support to multiple research initiatives undertaken across the University. The Javett-UP Art Centre also provides a unique space for curating material and visual cultural expressions whose histories and scale offer a rich window into Africa's heritage and aesthetics. Also included in this chapter is a supra-institutional project that has brought together eight research-intensive universities in South Africa to advance scholarship in curriculum transformation. While not an institute or research centre, this far-reaching project was conceptualised in response to the social movement for transformation in the higher education landscape since 2015. The project, entitled 'Unsettling Paradigms: The Decolonial Turn in the Humanities Curriculum at Universities in South Africa,' has stimulated and strengthened work in the vital but under-researched field.

The Centre for the Advancement of Scholarship, Engineering 4.0, Future Africa and FABI, although unique, both in terms of their origins and research thrust, are nevertheless united in their singular goal to encourage collaborative and transdisciplinary research that is both cutting-edge and international. They are not only driven by high research impact in pushing the frontiers of knowledge, but equally by the need to bring about social impact and a closer engagement with different communities of practice, whose direct interface with multiple stakeholders is often ignored in the academy. They offer the space for intellectual dialogue, cross-disciplinary exchange of ideas, and a platform for collaborative research that is crafted around the new and challenging problems that society faces. In different terms, these research entities embrace the University of Pretoria's overarching vision of being a "leading research-intensive university in Africa, recognised internationally for its quality,

relevance and impact, and also for developing people, creating knowledge and making a difference locally and globally."

In order to realise their vision, these entities work to foster a multi- and transdisciplinary research environment, which is also aimed at training a new type of researcher who is adept at moving with an ever-changing research environment and the challenges facing our developing nations as they grapple to move out of the industrial revolution into the fourth industrial revolution. So much of the research provenance has to be post-disciplinary, adaptable and geared towards a rapidly transforming society, while globally engaged and networked. The work being undertaken at Engineering 4.0 is a good example of such research. Similarly, FABI, which has one of the longest histories in the kind of research referenced here, has perfected cutting-edge research with global footprints and provenance. Its work is locally situated while simultaneously benchmarked against some of the best research practices in the world. The Centre for the Advancement of Scholarship's range of transdisciplinary research initiatives and projects, and its extensive network of collaborative research beyond our national boundaries, is positioned as one of the most engaged research entities locally and internationally. Of significance for the centres at UP, is the work they are doing in the training of a new generation of scholars, both at postgraduate and postdoctoral levels.

The institutes and centres attract scholars way beyond our borders and therefore contribute in situating the University of Pretoria as an African university with a global reach and relevance. It is fair to argue that most of these entities, even those with a deep history extending into UP's past, thrived under the leadership of Prof Cheryl de la Rey. Indeed, the

new kids on the block — such as the CAS, Engineering 4.0, the Javett-UP Art Centre and Future Africa — were given their initial impetus by Prof De la Rey whose vision and desire for cutting-edge research undoubtedly became the driving force behind these unique entities. It is not surprising that her office raised the funding for the physical infrastructure of these entities and platforms that would become, in many ways, the face of a transformed UP and the place to go when convening

diverse intellectual voices in Gauteng and further afield. They are the envy of our competitors in the region and worth every cent invested in them. What follows are individual accounts of what these institutes and research hubs achieved during the tenure of Prof Cheryl de la Rey.

*Prof James Ogude*

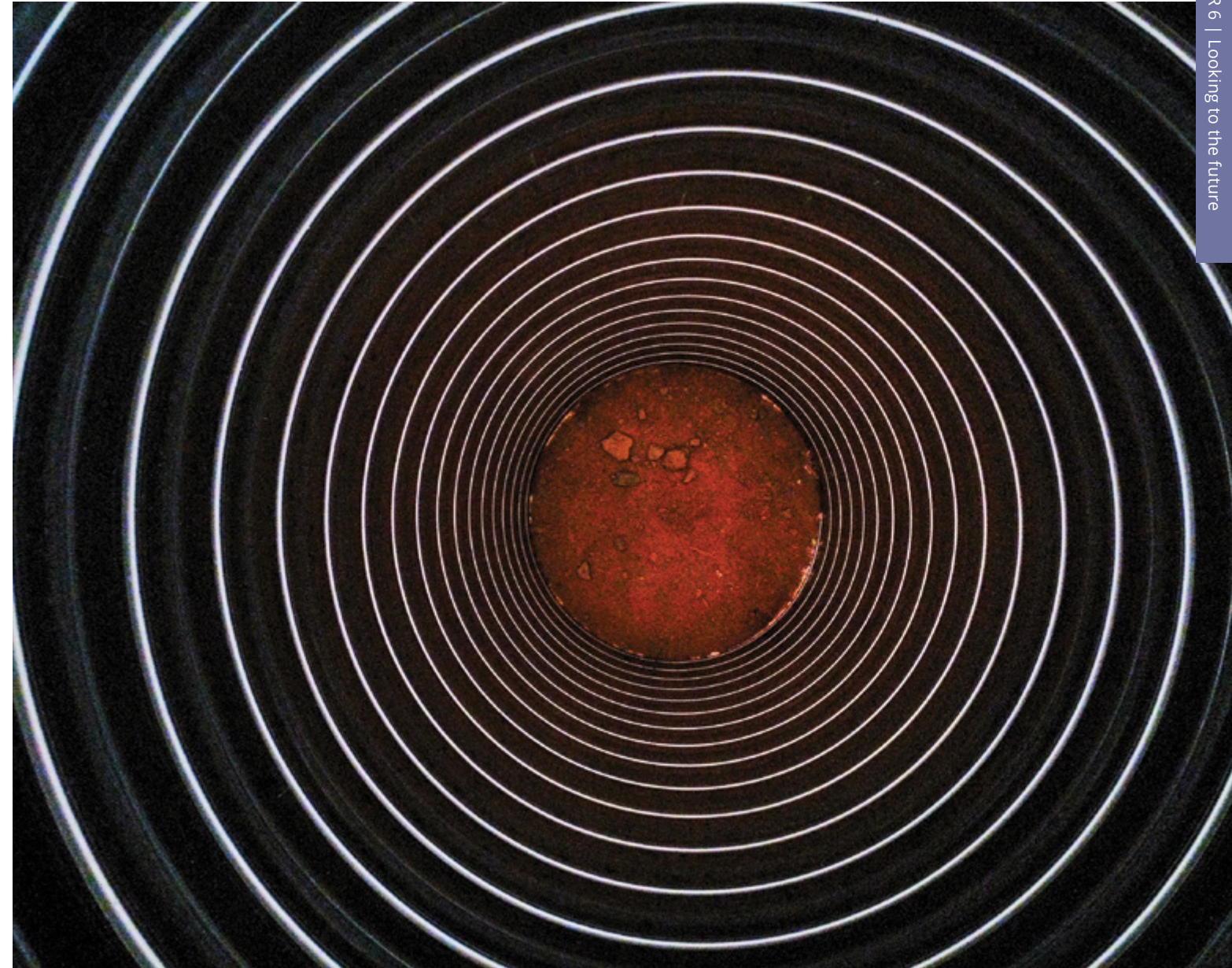

## 2 | Centre for the Advancement of Scholarship

The [Centre for the Advancement of Scholarship \(CAS\)](#), at the University of Pretoria, was founded in 2013. The Centre was a major reconfiguration of the earlier Unit for Advanced Study that was established in January 1999, under the leadership of Prof Nico (N) Sauer. The aim then was for the Unit to play a role in fostering multidisciplinary research within the University and to provide an academic home for research fellows outside of faculties and departments.

Prof Robin Crewe, Director 2013–2017 | Prof James Ogude, Director 2017–

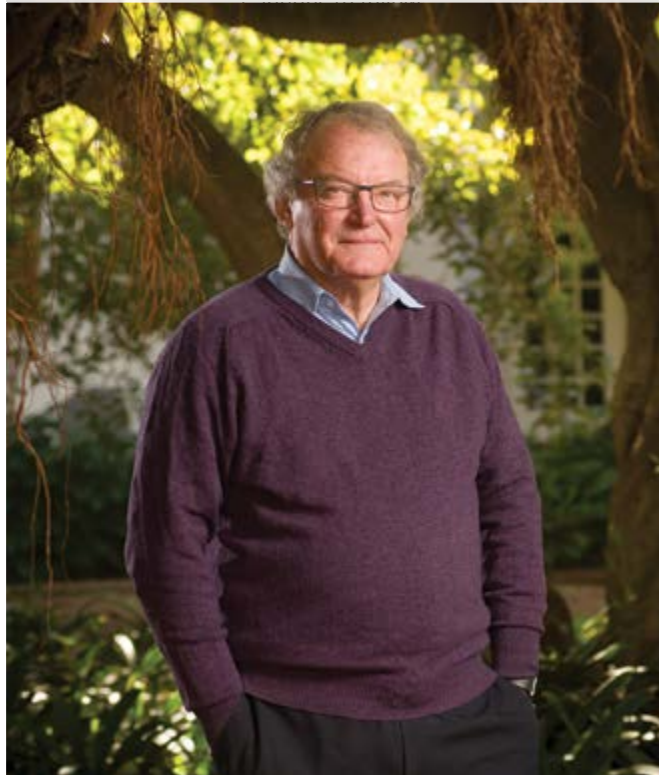

appointed as the first full-time director to manage this newly rebranded research entity, with a clear mandate to develop the criteria for the recruitment of fellows to the Centre. From 2015 until 2018, Prof Cheryl de la Rey served as the Chair of the Centre's Advisory Board and helped in shaping its vision, working closely with highly experienced founding board members like, Profs Njabulo (NS) Ndebele, Hendrik (HB) Geyer and Theo (DT) Goldberg, among others.

The mission of the Centre is to contribute to UP's overarching vision to be a leading research-intensive university in Africa. The Centre contributes to this by providing an environment where multi- and transdisciplinary scholarship can flourish. The Centre aims to provide a home for selected distinguished scholars to engage the University for short periods of time; to retain senior scholars so that they can continue their research activities and mentor postgraduate students and young academic staff; and to provide a physical home on campus for interaction between senior and visiting scholars, postdoctoral fellows and doctoral students.

While these foci remained relevant, a fundamental reorganisation of this Unit's vision and mission was needed to turn it into an important research hub in the University. This also entailed addressing some of its shortcomings, and providing it with a physical location on campus. In 2011, the Executive and the Senate approved a proposal to transform the Unit into the Centre for the Advancement of Scholarship and in 2012 funding was made available for the renovation of the Old College House, formerly used as the Student Affairs building, to become the physical location of the new Centre on the Hatfield Campus. In 2013, Prof Robin (RM) Crewe was



Centre staff with Prof De la Rey, November 2018

Prof Crewe was the driver behind the overhaul of the Centre and its repositioning locally and internationally. At its inception, the Centre consisted of Prof Crewe, three administrative support staff and a small group of senior research fellows; by 2014 the cohort of fellows had increased to seven senior research fellows. In 2018, the Centre had expanded to 10 senior research fellows, and had embarked on an aggressive postdoctoral fellowship recruitment, reflected in the growth of this group of researchers in later years at the Centre.

In 2017, Prof James (J) Ogude was appointed as the successor to Prof Crewe, and took over as Director of the Centre. He had previously served as Deputy Director since 2013.

### **Projects, publications and awards**

Between 2009 and 2018, the Centre hosted a number of projects, with five projects reported in 2014. These most notably included, the Templeton World Charity Foundation (TWCF) funded project on 'The meaning and value of Ubuntu in human and social development in Africa', which was led by Prof Ogude. Other projects at the time included the Andrew W Mellon Foundation funded Human Economy programme, the Centre for the Study of Governance Innovation (GovInn), and the Capital Cities project.

Over the next five years, the Centre's projects expanded to include the African Observatory for Humanities for the Environment, the Agricultural Transformation in Africa (ATA) programme, and Peer-Learning for Emerging Researchers' Knowledge and Advancement (PERKA). At the end of 2018, the Centre was awarded funding by the Andrew W Mellon Foundation for a five-year supra-national project titled 'Entanglement, mobility and improvisation: Culture and arts in contemporary African urbanism and its hinterlands', in collaboration with the universities of Cape Town, Makerere and Ghana.

The projects at the Centre reflected its strategic vision to foster multi- and transdisciplinary research within the University, and to provide a space for dialogue and interaction of scholars across disciplines and generations. Since its founding in 2013, there has been a deliberate drive to encourage research in the broad areas of Humanities disciplines, evident in the range of Humanities focused projects hosted at the Centre. In 2018, the Humanities for the Environment programme became the signature project of the Centre, with the sole aim of fostering transdisciplinary research. The central theme of this signature project is 'The poetics and politics of extraction and the environment in Africa'.

The Centre produced 23 books, both edited volumes and authored manuscripts, 25 book chapters and 75 articles published in academic journals between 2014 and 2018. Most notably, in 2018/2019, the Centre had two edited volumes published as major outputs from the Ubuntu project, which included *Ubuntu and Personhood* (Africa World Press, 2018) edited by Prof James Ogude; and *Unfolding Narratives of*

*Ubuntu in South Africa* (Routledge, 2019) edited by Prof Julian (JC) Müller, Dr John (JLB) Eliastam and Dr Sheila (S) Trahar. In 2019, a further two edited books were published from this project. The Human Economy Programme published eight volumes in its Human Economy series overseen by Prof John (J) Sharp and Prof Keith (K) Hart.

Other major outputs in the review period at the Centre included the 2015 and 2017 publications by Prof Charles (C) van Onselen. In these two years, Prof Van Onselen authored two books to widespread acclaim: *Showdown at the Red Lion: The Life and Times of Jack McLoughlin, 1859-1910*, and *The Cowboy Capitalist: John Hays Hammond, the American West, and the Jameson Raid in South Africa* — both published by Jonathan Ball. In 2017, Prof Van Onselen was also awarded the Human Sciences Research Council (HSRC) Annual Medal in Social Sciences and Humanities, an award conferred annually on a scholar who has made an outstanding contribution to research in the Social Sciences and Humanities.



Launch of *The Dark Side of the Hive: The Evolution of the Imperfect Honey Bee* by Prof Robin Moritz and Prof Robin Crewe

In 2013, Prof Crewe was awarded the first and one of only two Gold Medals for Outstanding Meritorious Service from the Academy of Science of South Africa (ASSAf); and in 2015 two Centre books were awarded the Vice-Chancellor's Book Award for scholarly books, monographs or collections: Prof Lorenzo (L) Fioramonti was the recipient in the Humanities and Social Sciences category, for his book *Gross Domestic Problem: the politics behind the world's most powerful number* (Zed Books, 2013); and Prof Jan (J) Boeyens was the recipient in the Natural and Applied Science category for his book, *The Chemistry of Matter Waves* (Springer, 2014). In 2016 Prof Chabani (NC) Manganyi was recognised with the NRF Lifetime Achievement Award. In 2018, Prof Manganyi received the ASSAf biennial Humanities Book Award for his memoir, *Apartheid and the Making of a Black Psychologist: A Memoir* (Wits University Press, 2016).

### Highlights of events and people

The Centre also hosted a number of significant events in this period. In November 2013, the Centre hosted an event titled 'Celebrating the legacy of Chinua Achebe: A critical reflection on Achebe's contribution to Africa's literary landscape', which also served as the launch of the Centre. The keynote was given by the late Mbulelo (MV) Mzamane, one of South Africa's foremost writers and scholars of African letters.

The Centre has had two of its senior research fellows invited to present at the University's Expert Lecture Series. In 2014, Prof Ogude presented on the topic 'Great expectations and the mourning after: A literary anatomy of post-independence politics in Africa'; and in 2016 Prof van Onselen presented on the topic 'Sunny places for shady characters: The making of work class cultures in southern Africa's mining revolution, c1886-1914'.

Within the Ubuntu project, from 2013 until 2017, the Centre hosted a number of colloquia with guest presenters such as DA Masolo, one of Africa's foremost philosophers based at the University of Louisville, Kentucky (US) and an authority on self

and community in Africa; and South African poet and writer, Wally (MW) Serote. In 2016, under the banner of the Ubuntu project, the Centre started the production of *Mama Mudu's Children*, directed by Masitha (M) Hoeane, which performed at the Aula and the Soweto Theatre, to full capacity audiences.

The Centre has hosted a number of visiting professors over the years who have presented seminars at the Centre. These include, Dr Geoffrey (G) Harpham, Director of the National Humanities Centre, North Carolina (US); Prof Akosua Adomako (AA) Ampofo, president of the African Studies Association of Africa (Ghana); Prof Eileen (E) Julien, a professor of Comparative Literature, French and Italian Studies in the College of Arts and Sciences at Indiana University, Bloomington (US); and Prof Joni (J) Adamson, Director of the Environmental Humanities Initiative (EHI) at Arizona State University (US).

### Conclusion

Since its inception, the Centre has focused on establishing research projects and growing its multi- and transdisciplinary focus. In the five years under the purview of Prof Cheryl de la Rey, and thanks to her unwavering support, the Centre developed a critical mass of researchers and projects to extend its focus into Humanities disciplines, per its mandate. The Centre also developed a strategy to foster meaningful, high-quality transdisciplinary research and a platform for the recruitment and mentoring of postdoctoral fellows. It has endeavoured to become a hub for projects that respond to societal issues, while equally extending its academic networks internationally, as was recently noted by the external review panel of the Centre. The Centre continues to grow and expand, working in conjunction with other like-minded entities at the University of Pretoria, such as Future Africa, the Javett-UP Art Centre, and some faculties at UP, to further multi- and transdisciplinary research, in an effort to enhance the research vision and international profile of the University, especially in the development of early career scholars and creating global linkages in Africa and beyond.

### 3 | Forestry and Agricultural Biotechnology Research Institute

The *Forestry and Agricultural Biotechnology Research Institute* (FABI) was established as a stand-alone postgraduate research institute at the University of Pretoria in 1998.

The overarching aim of the Institute was to drive transdisciplinary research across the broad plant-based biological sciences, mainly residing in the Faculty of Natural and Agricultural Sciences (NAS). This focus was also strongly linked to the rapidly emerging and powerful recombinant DNA technologies that were significantly shaping research depth and excellence across all spheres of biology. During its first 12 years of existence and thus up to 2009, FABI had rapidly established itself as one of the foremost research units at the University, having a substantial international footprint for excellence in the broad plant sciences.



The foundation that provided for the establishment of FABI was a programme established at the University of the Free State (UFS) in 1990, known as the Tree Pathology Co-operative Programme (TPCP). The TPCP team, comprised of five academic researchers and approximately 50 postgraduate students, moved to the University of Pretoria in 1998, providing the catalyst for the establishment of FABI. An immediate goal was to expand the focus of the research and education project to include the broader agricultural sector, while also fortifying the forest tree health programme. By 2009, substantial progress had been made towards this goal, having, by that time, established research programmes focused on the banana industry, the avocado industry, grains research and a significant programme dealing with the genetic improvement of trees important to the South African Forestry Industry.

During the 2009–2018 period, most of these areas were substantially expanded and grown. Exceptions were the banana research programme that was closed due to the

financial constraints of that industry, and the Centre for Applied Mycological Research, which had been established in a partnership with the Council for Scientific and Industrial Research (CSIR) and had not gained sufficient momentum to justify continuation. The research leaders of these two programmes, Prof Altus (A) Viljoen and Prof Gert (G) Marais respectively, had also chosen to move to other universities in South Africa.

A major point of growth for the tree health programme in FABI was to integrate an entomological component into the TPCP. This meant changing the name of the programme from Tree Pathology Co-operative Programme to the Tree PROTECTION Co-operative Programme. This major change came about due to the South African Forestry Industry's in-house research institute, the Institute for Commercial Forestry Research (ICFR), losing its capacity in entomology. The TPCP Board voted to integrate their research needs in forest pathology and forest entomology at FABI formally in 2003. This led to a very substantial growth in the TPCP from that point onwards, and specifically due to increasing insect pest problems affecting plantations in South Africa. The change was also consistent with the fact that insect pests and microbial pathogens commonly act together in affecting the health of trees. The integration of pathology and entomology research in the TPCP at FABI substantially increased the impact of the group internationally to become the world's largest single research programme working on the health of trees, particularly in planted forests.



### **Industry and government support for research**

Understanding that external funding for research clearly defines the outcomes of any university research programme was and continued to be key to the growth and success of FABI. At the outset, the founder team of the Institute came to the University with substantial funding from the South African forestry industry, which included private companies as well as government. The government funding was broadly matched against private industry funds and the University provided salaries for the core academic staff and most of the physical facilities. This 'leverage' model was utilised as new industry and partners established research programmes in FABI, and continues today.

While university research depends on external funding for success, it is crucially important that the external funding agencies understand that research excellence must include long-term objectives that go beyond the short-term problem-solving that typifies operations research. Failure to achieve a clear balance in this regard means that research is inevitably local in nature and far from world-leading. FABI managed very effectively to achieve this balance in all its projects and this has defined its trajectory to world-leading research excellence, well-illustrated in all the key metrics that measure this objective. It has thus also led to large numbers of postgraduate students joining the Institute from many different countries. It has likewise initiated global collaborations with groups from many different regions in the world.

During the first approximately 15 years of FABI's existence, most of the research programmes benefitted from the Technology and Human Resources for Industry Programme (THRIP) funding supported by the Department of Trade and Industry. This co-funding opportunity changed numerous times from its inception to accommodate various government mandates, but overall provided outstanding support for postgraduate education. The effective closure of THRIP in 2015/2016 meant a substantial loss of financial support not only for FABI but for most industry-supported research programmes in South Africa. There is no question that it resulted in a substantially lower number of postgraduate students entering research projects in the country.

A major growth factor for FABI came with the government Department of Science and Technology (DST), now Department of Science and Innovation (DSI), recognising the tree health programme in FABI as one of the first six government supported Centres of Excellence (CoE) in South Africa. This led to the launch of the Centre of Excellence in

Tree Health Biotechnology (CTHB) in 2004. This was initially half-funded, due to the view of the DSI that it had substantial funding beyond what was being given to the other four CoEs. A strong argument was launched against this decision and the CTHB was given full funding from the start of the second of three funding terms (2008–2012 and 2018). This substantial base of funding required the incorporation of research projects at a number of other South African universities, where the team at FABI needed to ensure funding for those projects. While somewhat onerous, this also meant a substantial deepening of FABI's research programme focused on tree health.

### **A model for postgraduate mentorship and development**

During its first 20 years of existence and beyond, FABI provided an outstanding model for postgraduate education. This has been recognised widely within the UP environment and also nationally. There are many factors that contributed to this success. Perhaps the most important is the fact that as a stand-alone institute, FABI is substantially different from a typical university department. Postgraduate students work in a deeply multi- and transdisciplinary environment and benefit from exposure to areas of research that are much more diverse than would be possible in a single department. Likewise, the academics running research programmes in the Institute come from a broad range of disciplines, making collaboration across these domains easily available. The same applies to research funding opportunities where it is common to offer funding bodies a broad range of skill sets that facilitate solving their problems.

### **Structural leadership and changes during the period**

A key factor driving the success of FABI, and that defined the second ten-year period of its existence up to 2018 and beyond, has been the critical mass of postgraduate students whose work was characterised by close engagement in the Institute. By the end of this period, FABI had grown to include approximately 200 MSc and PhD students and postdoctoral research fellows, led by a team of approximately 24 academics. All academics in this case had appointments in faculty departments (Biochemistry, Genetics, Microbiology, Zoology and Plant Sciences) but conducted the bulk of their research within the Institute. Of this team of academics, nine were specifically assigned to FABI and thus reported to the Director of the Institute.



A common feature of research teams or institutes in universities is that the majority of academic staff are connected to the core only by association or personal choice. This implies that, other than say the Director and secretarial support, the research entity rests on a fragile structure, which in many cases might not be sustainable.

During his term as Dean of the Faculty of Natural and Agricultural Sciences, and later as Vice-Principal: Research, Prof Robin (RM) Crewe recognised that FABI required a core team of full-time academics reporting primarily to the Director of the Institute. This is an unusual structure for institutes at UP, but there is no question that it has been key to the growth and sustainability of FABI. While the FABI academic staff all have linked positions in faculties, their core deliverables relate to research and to building research programmes important to strengthening research excellence. While they all have

formal undergraduate teaching responsibilities, the load is lower compared to academics within department.

Another key feature defining the success of FABI has been the fact that students in the Institute represent a remarkable diversity of cultures. At one point during the second decade of the Institute's existence, a count showed that there were 30 mother-tongue languages spoken among the student community. This number has obviously fluctuated over time but it illustrates a deeply multicultural environment. This has been driven by a number of factors, not least by a commitment by the FABI leadership strongly to promote cultural diversity. The fact that the Institute has had a deep global reach with students from many different countries of the world has also been a key factor. It is clearly evident that cultural diversity has strongly driven research depth and excellence in FABI.

### Significant outputs, achievements and events hosted

As FABI grew during the 2009 to 2018 period, there was a continued growth of research outputs, measured using all typical metrics. These are summarised in-depth in the regularly produced Biennial Reports<sup>1</sup> of the Institute. Over this period, FABI has come to have a very substantial international research footprint with students and staff having tangible publication outputs with colleagues in many different countries of the world. Research outputs have continuously grown not only in numbers but also in quality with a very substantial focus on publication in high impact journals such as *Science* and *Proceedings of the National Academy of Sciences (PNAS)*.

FABI staff and students have been the recipients of a large number of awards both locally and internationally. These are far too numerous to list but locally it is relevant to note that the FABI academics all have NRF ratings including three A-ratings, seven B-ratings and three staff members with NRF President's Awards. Three FABI academics have been on the Clarivate Web of Science most highly cited list, in one case continuously for several years. Likewise, several FABI academics have held or continue to hold very significant positions on influential scientific bodies. Prof Michael (MJ) Wingfield as Director, received two honorary DSc degrees (North Carolina State University, US and the University of British Columbia, Canada), largely recognising the outstanding international footprint in the field of tree health in FABI.

<sup>1</sup> <https://www.fabinet.up.ac.za/index.php/fabi/fabi-biennial-reports>

<sup>2</sup> Michael Wingfield, *The FABI Story. The Road to Research Excellence*. January 2018.

### The second FABI decade ends

During the course of 2017, FABI founding Director Prof Wingfield made the decision to step down from this position. This was primarily based on his view that the Institute had come to a point where it would benefit from new leadership. There was a clear opportunity to extend the research platforms, largely but not exclusively in the fields of tree (forestry, fruit) health to a much wider sphere of impact. For example, one of the strongest biological control programmes for tree pests had been built in FABI and this could clearly be extended to the broader fields of agriculture. Likewise, opportunities such as expanding the powerful base of disease diagnostics beyond tree health were obvious, but these could only be achieved through new thinking and new leadership.

Prof Mike Wingfield stepped down from the directorship of FABI at the end of 2017. This followed a year-long process conducted by the UP Executive to appoint a new director. Prof Bernard (B) Slippers, a highly recognised academic with long-term experience working as part of the FABI leadership team, was identified as the new director, taking over this role in January 2018.

FABI organised an international symposium entitled 'The Road to Research Excellence'<sup>2</sup> to mark the occasion of the 20th anniversary of the Institute. The event included keynote speakers representing major role-players from South Africa and globally who had been involved in building the Institute. A narrative summary of the history of FABI was released on this occasion, providing a broad historical perspective of the first two decades of the Institute. The two-day commemoration of FABI also included a tree planting ceremony as a symbolic gesture of FABI's contribution to research and the environment, and an art exhibition of trees and sculptures curated in partnership with the University's Department of Arts.





## 4 | Future Africa

A fitting conclusion to Prof Cheryl de la Rey's term as the UP Vice-Chancellor and Principal in this period, as she was the driver behind the Future Africa project, was her farewell function held at Future Africa on 29 November 2018.



Prof Bernard Slippers, founding Director of Future Africa | 2014–2018

The critical need for transdisciplinarity, internationalisation and social responsibility of science was increasingly prominent in discussions on the future of science development globally. As captured in a statement by Philip Sharp, Nobel Laureate in Medicine, and Alan Leshner, CEO of the American Association for the Advancement of Science (AAAS) — the world's largest general scientific society:

“Searching for solutions (to today's global challenges) requires that the scientific community operate in fundamentally new ways... Developing effective solutions requires converging approaches, such as the integration of knowledge from the life, physical, social, and economic sciences and engineering... Research-performing and training institutions, such as universities and research institutes, have critical roles to play... it is essential that they develop appropriate training programs and help stimulate multidisciplinary international collaborations.”<sup>3</sup>

This realisation was driven by the scale and complexity of challenges facing societies around the world and was brought into sharp focus in the University's long-term vision and strategy, UP 2025.

UP was seen to be especially well-placed to play a leading role in Africa and to position the University as a continental and global research network and hub for engagement on major developmental challenges. It was considered by many as one of the few universities on the continent that had the capacity, stature and resources to position itself as a ‘one stop shop’ for Africa and the world to meet and to engage on the grand challenges of the future.<sup>4</sup>

In this context, Prof De la Rey initiated a process in November 2013, based on a pre-proposal developed by Prof Bernard (B) Slippers, to develop a platform that would aim to address two overarching goals for UP:

- To become a vehicle for the active development of *fundamentally* new types of scholars, projects and research networks.
- To address a critical shortage (or lack) of *integrated platforms* for postgraduate, postdoctoral and visiting scholar research and training, and to support incubators of knowledge production; this would offer the opportunity to develop a dynamic living and learning environment where a community of scholars can engage to

<sup>3</sup> Sharp PA, Leshner AI. 2014. Meeting global challenges. *Science*, 343: 579. DOI: 10.1126/science.1250725

<sup>4</sup> Slippers B, Vogel C and Fioramonti L. 2015. Global trends and opportunities for development of African research universities. *South African Journal of Science*, 111(1-2): 1-4. <https://dx.doi.org/10.17159/sajs.2015/a0093>

advance excellence in scholarship, dialogue and social responsibility across disciplines, cultures and generations.

Prof Slippers was seconded to the Office of the Vice-Chancellor in January 2014 to work on the project, with the ideas refined to what became the Future Africa project in the first half of 2014. The original proposals considered, in particular, the work of Young Academies, the Collegiate Model and Centres for Advanced Study at leading universities, the Future Earth project by the International Social Science Council (ICSSU), now the International Science Council (ISC), as well as the 2010 internationalisation strategy of UP, developed by a team of UP academics led by Prof Christof (CJ) Heyns who actively participated in the development of the Future Africa proposals.

In the words of Prof Heyns, the exact place is captured of where the Future Africa campus was developed:

“The UP sports grounds and experimental farm, with their trees, dams and open spaces, offer the kind of tranquillity and peace of mind that one does not necessarily expect in a busy city. It is close to the University and to the Hatfield and Brooklyn business and recreation areas. It also offers access to top-class sporting and gym facilities. On the southern rim of the experimental farm there is a large area — with a bit of a view over the farm — that is currently used essentially as a scrap yard for old farming equipment that could be considered for this purpose.

“Further up the red brick road, on Strubenkop, past the house of the farm manager, one can take a footpath to the left, pass the covered reservoir, and make your way up to a point above some rocks where there is an area with a 180-degree view of Pretoria. If it is not designated as a green area, this would be ideal for such a venture. Standing there with your back to the koppie, with the twin towers of the Union Building on your left, you can see the tall structures of the University of Pretoria nearby, while you face north. This is the direction of the vast continent of Africa, the cradle of some of the best and of the worst in the history of the human race. In a few weeks the trees in the orchard below will start blooming. One can easily imagine that some of the ideas that will change the future of humanity will enter human consciousness here.”<sup>5</sup>

The idea was of an institute becoming the anchor strategy of UP as ‘Africa’s Global University’.

<sup>5</sup> University of Pretoria, August 2010. Africa’s Global University: Report to the Executive by the Task Team to Develop an Internationalisation Strategy, pp.42–43.



## A chronology of milestones and events

In May 2014, the UP Executive approved a formal proposal for the 'Future Africa: Transdisciplinary Science Leadership for Innovation' project to advance transdisciplinary capacity development and internationalisation with Africa as a core focus; the development of a facility to house the Future Africa project; and the appointment of a steering committee. The steering committee comprised Profs Slippers (Director), Anton (A) Ströh, Norman (N) Duncan, Lorenzo (L) Fioramonti (Deputy-Director) and Coleen (C) Vogel, with Profs Robin (RM) Crewe and Heyns acting as advisors to the committee.

Following a call for the expression of interest from architects, and two rounds of proposals from a shortlist of architectural firms, Earthworld Architects was appointed. Three potential sites were identified for the development of Future Africa and the south-eastern corner of the Hillcrest Experimental Farm site chosen, in alignment with recommendations for the redevelopment of this space, which were the outcome of an external review in September 2014.

The development of the Future Africa site and infrastructure was overseen by Prof Antonie (AM) de Klerk in his position as Executive Director on the UP Executive, together with the Future Africa Steering Committee.

Further consultation meetings took place with the UP Executive, deans, directors of institutes and all major departments affected or involved with the Future Africa project throughout 2014. Other than the concept, academic focus and development programmes, and the building designs, a key component of the final proposal was a business model for the financial sustainability and motivation for the capital investment. Prof De Klerk and Marietjie (M) de Waal (Department of Finance) were instrumental in this process.

In November 2014, Council approved the funding for the construction of Future Africa. The refinement of designs was undertaken by Earthworld Architects, in consultation with academics and UP Facilities Management during 2015. Further funding was approved in July 2016 for the development of the conference facility at Future Africa.

The latter part of the process was led by Profs Slippers and Fioramonti, and overseen by Prof Ströh, following the retirement of Prof De Klerk in 2015.

A proposal for the formal establishment of Future Africa as an institute was approved by UP Senate in 2018. Also in 2018,

as the construction of the Future Africa campus was nearing completion, the Vice-Principal: Research and Postgraduate Education, Prof Stephanie (SG) Burton, was appointed as the Executive member responsible for overseeing the operationalisation of Future Africa. Interim organisational structures were set up to facilitate the processes of decision-making and to ensure the implementation of those decisions.

A philosophy of participation, inclusivity and collaboration was adopted as being central to the functioning of these structures.



## The start of operations

Agreements for collaboration were signed with the African Institute for Mathematical Sciences (AIMS), the Next Einstein Forum, and Microsoft, among others.

Three appointments were made in this first phase of Future Africa's operations:

- Smeetha (S) Singh was appointed in July 2015 as programme coordinator of the Africa Science Leadership Programme (ASLP).

- Amelia (A) Cilliers was appointed as Future Africa's project manager in mid-2016 and helped oversee all elements of the engagements, planning, budgeting and administration as the project developed over the following years.
- Following a call for the expression of interest and two rounds of presentation from design companies, Albino Creations was appointed to design a logo for Future Africa in May 2016 and a style guide for the development of the Future Africa website in June 2016.

Importantly, the logo captured themes of the African continent, circular African design elements, inter-connectedness, biological cells and chemical structures. The logo was registered as a trademark of UP in June 2018. Apart from the website and associated list servers, social media platforms (Twitter, Facebook and Instagram) were also actively developed and promoted during this period.

### Science leadership programmes

A significant first programme of Future Africa was developed following funding from the Bosch Foundation to establish an African Science Leadership Programme (ASLP), linking and equipping science leaders from across the continent, under the leadership of Prof Slippers and in collaboration with the Global Young Academy (in particular, Dr Eva (E) Alisic, University of Melbourne, Australia).

A knowledge and development facilitation company, KnowInnovation, was key in the development and implementation of the ASLP programme, together with the leadership of the Leopold Leadership Programme at Stanford University (US).

The programme included 20 fellows per year and, from the start, had a significant reach given its unique approach and impact. The ASLP concept was taken up and expanded globally via the Global Young Academy, including the Association of Southeast Asian Nations (ASEAN) region and at their global gatherings. Funding for the programme was renewed in 2018, and satellite programmes were then developed via the ASLP in South, East, West and North Africa.

By 2018, the programme had become one of the most visible science leadership programmes globally, reaching and linking hundreds of young scientists around the world.

A Tuks Young Research Leader Programme (TYRLP) was also established at UP using the ASLP concept. Between 2015 and 2018, this programme impacted and connected 80 young researchers from across UP's faculties. It created a vibrant and inspiring space. The TYRLP programme aimed to grow early career academics at UP in the areas of thought leadership, team development, engagement and collaboration with the intention of enabling them to solve the complex issues that face society. The programme formed a community within the University of like-minded young researchers who would contribute to UP becoming a leading research-intensive university.

A Carnegie funded Early Career Research Leadership Fellowship (ECRLF) postdoctoral programme also flowed from these programmes. Dr Nokuthula (N) Vilakazi was appointed as coordinator of the programme. The programme design for the ECRLF aimed to stimulate new thinking on the perceived frontiers of science to produce theoretical frameworks for transformation, develop novel questions and/or novel approaches to old and emerging new questions with a focus on adaptability, resilience, and co-design of systems for sustainable and equitable development in Africa.

The programme functioned through a twinned, split-site approach with the home institution to strengthen the research of the fellow at her/his home institution as well as the hosting institution. The ECRLF aimed to grow African academics with an intention to stimulate the emergence of centres of research excellence to solve complex problems that face Africa and the world.

The communities of young research leaders in the ASLP, TYRLP and ECRLF were seen as the start of developing a network of researchers linked to Future Africa across the continent. This community was virtually linked through a programme emerging from the ASLP called ConnectUs.Africa, to networks of young researchers linked to Young Academies and other initiatives on the continent.

### A new beginning

The Future Africa launch took place on 29 March 2019, with planning having started in mid-2018. Apart from the main programme, the launch was planned to include workshops on science leadership in Africa, transdisciplinary research in Africa, and science communication and science diplomacy in Africa, which heralded in new beginnings.

### The campus and gardens

The Future Africa campus was designed to revolve around a lifestyle of research excellence and collaboration, with a deliberate focus on how design can play a role in fostering critical thinking and research. Drawing on the contemporary eco-village solutions, and ideas from the Stanford Woods Institute for the Environment, communal areas were designed to spur creative thinking and innovation.

The Future Africa campus includes a conference centre, a dining hall, administrative and research offices, and 265 living units ranging from single bedrooms to family units.



The research commons, for example, is designed to use the interconnectedness between different spaces in the flow designed between informal discussion areas, meeting rooms and study tables. The conference centre is the focal point of the campus, where knowledge as a collective is pivotal to the campus.

The gardens were landscaped and plant species carefully chosen to ensure that much of the vegetation is edible and could be used in the kitchens and, into the future, as a useful focus of research. The possibility of an urban landscape providing food for fauna and people also highlights the predominantly indigenous landscape as a food resource, and how this resource can be used.

### The main features

The main features and activities of Future Africa would include:

- An innovative research environment, as illustrated in the design and landscape of the Future Africa campus.
- IdeasLab-type workshops<sup>6</sup> that bring together communities of practice from across Africa and globally to engage in challenges that require transdisciplinary solutions.
- Frontiers research projects that flow from IdeasLab workshops and the [Global Innovation Forum](#) (see below) and that can be developed into innovative

<sup>6</sup> The IdeasLab concept is applied widely. See for example, <http://knowinnovation.com/ideas-lab/>

transdisciplinary projects. The ultimate aim would be to have a coherent programme on the new frontiers of research, with a special focus on adaptability, transformability and co-design of various social and ecological systems for sustainable and equitable development in Africa.

- Global Innovation Forum aimed at Future Africa taking the lead in hosting an annual gathering of 'innovators' from all over the world. If done strategically and building on existing initiatives (e.g., the annual Governance Innovation Week hosted by the UP Govinn centre, the efforts of the Centre for Human Rights, the newly established Centre of Excellence in Food Security and many other UP initiatives), this gathering holds the potential to become a leading global event in which the global innovation community — from research organisations to think-tanks and business and civil society — participate to tackle the world's most pressing challenges.
- The intentional recruitment of talented young researchers in Africa and globally with the aim of developing 'dream teams' that have unique skills in different disciplines, to partner with established senior scientists on frontier projects. Emphasis will also be placed on building leadership skills that will enable young scientists to play a critical role in the interface between science and policy in the 21st century, as well as to play a leading role in global research projects. A prestige African science leadership programme for early to mid-career researchers of exceptional potential will be offered in partnership with the Global Young Academy.
- The focus on academic mentorship as a foundational value of Future Africa to nurture a new generation of scholars at UP and in Africa. Learning from successful models at UP and elsewhere, Future Africa will offer bursaries to undergraduate students of outstanding quality to work with Future Africa PhD students. Furthermore, Future Africa research and postdoctoral fellows will be equipped to act as mentors in skills development programmes aimed at PhD students. A select group of early career academics, linked to the frontier research and leadership development projects, will be offered career advancement grants for paired

sabbaticals with research visitors at Future Africa, or at the research organisation of a leading scholar. All Future Africa fellows and, where possible, a broader scholarly community, will be regularly linked through social and academic activities to build relationships and enhance learning in a transdisciplinary context, with a focus on African development.

- Future Africa will seek to establish a *Nature Africa* online journal, in collaboration with the Nature Publishing Group. The journal will aim to highlight excellence in science from Africa on issues relevant to Africa, as well as science opportunities and dialogues relevant to African science. Attempts will also be made to build similar partnerships with leading journals such as *Science*.

### Research focus areas, early ideas

The grand challenges facing Africa and the world have been analysed and prioritised through extensive processes such as those captured in the South African National Development Plan 2030, the African Union 2063 strategy, and the UN Strategic Development Goals.

Considering these in-depth analyses, and matching them to areas of research strength and opportunity at the University of Pretoria, four overarching research focus areas have been identified for Future Africa:

- Governance and development
- Human rights and social justice
- Bio-economy and One Health
- Convergence and sustainability science.

Many of the grand challenges facing Africa and the world lie at the intersection of the first three areas. In advancing these fields, an emphasis will be placed on the points of convergence between them, developing a centre of excellence in convergence and sustainability science. This emerging field aims to integrate knowledge from the life, physical, social and economic sciences, and engineering, and can play a critical role in narrowing the disconnect between science, practice and politics.

## 5 | Javett-UP Art Centre

### *The birth of a new gallery*

Prof Antony (AP) Melck, first appointed in October 2001 as advisor to the Vice-Chancellor and Principal, Prof Calie (CWI) Pistorius, and later as Executive Director responsible for institutional planning, chaired the University's Art Committee. In all these capacities, a growing number of tasks, questions and discussions were entertained over many years, which included matters such as selecting and caring for UP's artworks, housing them appropriately, exhibiting the (exam) work of Visual Arts students, managing UP's diverse museum collections, and the need for a single, permanent solution related to the foregoing. In relation to the latter point, two options were mooted: developing one of many possible existing venues, and building a new art gallery.

The idea of building a new art gallery was first mooted late in 2005, when the UP Executive accepted, in principle, a proposal that planning for a new building should start. It was realised from the outset that external funding would have to be found. In-principle agreement to proceed was followed by a meeting on 3 March 2006, convened by Prof Melck, with the heads of the departments of Visual Arts, Prof Marion (M) Sauthoff, and Architecture, Prof 'Ora (O) Joubert, to discuss the situation and to prepare a needs analysis for the Executive Director: Facilities, Prof Antonie (AM) de Klerk, a brief for an architect, and a fundraising brochure. This meeting agreed that the space adjacent to Lynnwood Road, between the Visual Arts and Architecture buildings, would be suitable for the new gallery, complete with the linkage it provided to staff and students. The new gallery would also connect both the South Campus and the historical buildings to the north, and would be suitable for housing student, contemporary, rotating (external) and corporate (University) collections.

At the time, the architect, Marcus Holmes was assisting UP with the restoration of the Old Arts Building. In addition,

Prof Alex (A) Duffey, Head of UP Arts, was preparing a new museum policy that would resort with the Registrar through a newly-formed University Heritage Committee. This was a response to the realisation that there were too many University collections to be housed under one roof.

Discussing architectural requirements at various levels in the University, and preparing a range of submissions and reports, took several years. Key in this regard was a report written by Dr André Breedt after a study tour to art galleries abroad in 2007. In October 2009 the University's Executive reviewed the identified needs, reconfirmed the establishment of an Arts Centre, and appointed Prof Schalk (SJ) Claasen as project coordinator and manager. Prof Claasen was seconded from the Faculty of Engineering, Built Environment and Information Technology (EBIT) for this purpose. A year later in September 2010, Prof De Klerk submitted the first cost estimates to the Executive. Prof Claasen was succeeded by Prof Anton (A) Coetzee and, from the beginning of 2014, by Prof Annél (A) van Aswegen, as coordinators.





Christopher Till, founding Director of the Javett-UP Art Centre



### Brokering a partnership

The possibility of external funding only became a focus during 2011. By that time, there had been a number of changes in the senior management of the University. Prof Cheryl de la Rey was the new Vice-Chancellor and Principal, and the new Heads of Department of Visual Arts and Architecture, were Prof Jeanne (J) van Eeden and Prof Karel (KA) Bakker respectively.

15 June 2011 is the date on which a future partnership was brokered. This was when Prof Melck met with Dr Conrad (C) Strauss and Stephan (S) Welz, both renowned in South African art circles, on their referral to the former by Dr Breedt. The two external persons agreed that the climate was favourable for establishing a new art gallery, requiring substantial donations (covering construction, running costs and artworks), and agreed that UP would be a suitable host given that the University was a well-managed and stable institution, located in the capital city, with an art collection and an active Visual Arts Department. They also indicated the next logical steps would be to make appropriate land available, and establish an independent legal trust, governed by trustees, to take responsibility for the collections and run the facility.

The final development began a few months later in 2011, when Mr Welz invited Prof Melck to a meeting with Michael Javett in Rosebank, Johannesburg. Mr Welz had been Mr Javett's advisor on art purchases for his personal collection. The matter of possible funding, as lead donor, for the new art gallery was raised. This was pursued further early in 2012 when

Mr Javett referred Prof Melck to his lawyer, Ed Southey, to prepare first drafts of a donation agreement and trust deed to underpin the venture. Prof Melck asked Prof Bakker to suggest an architect to assist with cost estimates, the result being the suggestion that Pieter J Mathews and Associates be approached. This decision was endorsed after a subsequent meeting between Mr Mathews, Mr Welz and Mr Javett.

On 2 October 2012, Mr Javett met Prof De la Rey, further cementing donation commitments subject to University Council support and approval. On 9 January 2013, Southey and Prof Niek (N) Grové, the respective lawyers of the Javett Trust and University, met and requested Prof Melck to brief the Standing Committee of Council, who responded positively. Through Prof De la Rey, grant and travel assistance was secured from the Andrew W Mellon Foundation, New York, for a study tour of art galleries and museums at leading academic institutions in the United States. From 20 to 31 March 2013, a delegation consisting of Mr Welz<sup>7</sup>, Mr Mathews, Prof Norman (N) Duncan (Dean of the Faculty of Humanities) and Prof Melck undertook this visit. Profs Melck and Duncan submitted a report to the UP Executive on 11 April on lessons learnt from the institutions visited.<sup>8</sup>

The outcome of these interactions was that Council, on 26 June 2013, authorised Prof De la Rey to enter into a legal arrangement in relation to developing the Art Centre. Council thus de facto approved that the University could commence with preparations to implement the proposal to establish a foundation and construct the gallery building. A Deed of Trust was signed on 13 June 2014 between the University of Pretoria as Founder and the Trustees for the new Arts Centre Foundation (ACF). The stipulations that provided for the University to make the land available for the building on the Hatfield and South campuses, including additional funding for underground parking on the South Campus, allowed Mr Javett to effect his intended donation of funding and the loan of artworks. The Master of the High Court issued the letters of authority to the Trustees in August 2014. The ACF was registered as a non-profit organisation and granted public-benefit organisation status by the South African Revenue Services (SARS).

### Linking with the capital city

Prof Melck had regular contact with the mayor and city manager of the City of Tshwane (CoT) during the conceptualising of Javett-UP and establishing the ACF. Prof Melck chaired the City's audit committee and could, at the appropriate time, submit to the CoT Executive the University's intention to approach the UP Council for support and permission to proceed with the Art Centre.

A first task was securing the rights for the proposed Art Centre building to be designed to cross Lynnwood Road. This was a key element of the plan for the Centre. 'The Air Bridge' Lease Agreement was signed with the CoT on 12 October 2016.

The tender process for the construction was concluded in August 2016 and Liviero Building (Pty) Ltd was awarded the contract. Site handover for construction took place on 27 June 2017. The completion and functional occupation of the building took place in May 2019 and the Occupancy Certificate was received at the end of August 2019.

### A vision beyond the arts

The Javett-UP's future work was embedded in its vision of contributing beyond the arts.

A workshop on the envisaged Art Conservation programme and related matters, held early in March 2015 at UP, led to Andrew W Mellon Foundation grant support, and the start of a master's programme in the Conservation of Tangible Heritage from 2019. A space in the gallery building was designated as a Conservation Studio.

Javett-UP Art Centre opened its doors for the first time in September 2019 under the leadership of Christopher (C) Till, its founding Director.

<sup>7</sup> Mr Welz passed away in December 2015.

<sup>8</sup> Museum of Modern Art (MOMA), The Metropolitan Museum of Art (New York), the Guggenheim Museum, the High Line precinct, the Whitney Museum of Modern Art, the University Museum at Rutgers, Yale, Princeton and Johns Hopkins Universities, the Baltimore and Pennsylvania Museums, and the Barnes Foundation and Museum.

## 6 | Engineering 4.0

**Engineering 4.0** is situated on the Innovation Africa@UP campus in Hillcrest and is officially part of the Faculty of Engineering, Built Environment and Information Technology (EBIT). It arose from a UP collaboration with the South African National Roads Agency (SANRAL), the Council for Scientific and Industrial Research (CSIR), and York Timbers.

Initial discussions for the development of the facility started in 2014, with talks between UP and SANRAL about a possible location for a national reference laboratory for road building materials. The discussions evolved to include a training laboratory, a concrete research laboratory, an accelerated pavement testing track, and an active traffic test track on the N4 that all became part of the package following discussions with various local and international peers and facilities.

The construction period for Engineering 4.0 stretched from 17 October 2018 to 28 February 2020, when the facility was officially handed over to UP — on time and within budget. This was achieved through the professional endeavours of UP Facilities, the professional team (consisting of the architects, engineers, quantity surveyors, etc.) and the contractor that strictly adhered to the plan, delivering a world-class facility. The description below provides an overview of the mandate, strategy and plans.

### **Mandate**

The original mandate of the Engineering 4.0 facility was to address the shortage of civil engineers in South Africa with specific reference to the provision, management and maintenance of roads infrastructure while providing a national facility for roads materials reference testing, and training, teaching and research in roads materials, construction, management and maintenance.

The national road materials reference laboratory will become the only site in South Africa for the independent testing of materials for the road construction industry. The training laboratory will train and certify road materials technicians employed by various testing laboratories to ensure that road materials testing in the country is up to standard. The concrete laboratory was designed to consist of preparation areas, curing and humidity rooms, and a test floor where various concrete and structural testing can be conducted for use in areas that include road construction and infrastructure.



Prof Wynand Steyn

An Accelerated Pavement Testing (APT) track will allow for the construction of different pavement structures and their accelerated evaluation, using a mobile APT device. This will enable engineers to monitor the expected behaviour of a pavement over a fraction of its life. The active traffic test lane on the N4 will be used to collect real-time data and use big data analytics, and the Internet of Things, to conduct tests and analysis on how different road surfaces perform, how traffic moves on the highway, density and type of traffic, emissions testing and air quality monitoring.

The York Wood Engineering Laboratory aims to expand the footprint of mass timber construction, using advanced engineered wood products on the continent, in collaboration with civil and chemical engineering, architecture, materials science, data science, genetics and other related bio-economy disciplines.

This mandate has evolved since the inauguration of the facility to include a hub of transdisciplinary thinking, collaboration and support at Innovation Africa @UP, supporting various entities in the vicinity with mainly engineering and technology support. Engineering 4.0 shares its vast resources in technology and data sciences with all faculties via the Future Africa Institute, a platform for developing inter- and transdisciplinary research networks within the University and the global research community — focusing on solving Africa's grand challenges.

### **Strategy**

The strategy employed in the development of Engineering 4.0 strongly focused on a partnership with industry. SANRAL had a clear requirement for developing capacity and knowledge in its domain of roads provisioning, while UP has had strong teaching and research interest over many years in the broad infrastructure, and focused roads infrastructure area. A strategic agreement for the development of the facility, therefore, made them equal partners in the development, with both CSIR and York Timbers coming on board as technology research partners to enable a collaboration that can address complex challenges while developing the next cohort of researchers, engineers, technologists and scientists for the region.

The strategy was amended after the completion of Engineering 4.0 also to include the wider support of transdisciplinary efforts on the UP Hatfield Campus, focusing mainly on the engineering aspects of collaborations with various entities.





Credit: Wynand Steyn

### Partnerships and plans

The facility was initiated as a partnership between UP, SANRAL, CSIR, York Timbers. UP and SANRAL each contributed half of the total budget to develop the facility, while CSIR and York Timbers both became active research partners to ensure a collaborative national research and development footprint.

The current Engineering 4.0 facility is Phase 1 of the masterplan development on the Innovation Africa @UP Campus, with further planning around provision of facilities for water, mining and mechanical engineering, autonomous vehicles and new energy planned as part of the next phases of development. All these developments are conducted with strong industry support and collaboration, with the aim of improving quality of life for all communities in South Africa.

### Themes embodied in Engineering 4.0 future work

The research themes have focused mainly on ways to improve quality of life around transportation for societies. Engineering 4.0 focuses on the development of integrated transportation and infrastructure systems, with research concentrating on the reduction of energy consumption levels in transportation, maximising productivity in industry and creating a higher quality of life for society. Specific research themes include road and general infrastructure materials and construction, smart transportation systems, vehicle-pavement interaction issues, traffic flow, infrastructure management, exhaust-related emissions, semi-autonomous and autonomous vehicles, and more. This will entail smart roads and infrastructure talking to smart vehicles, to reduce traffic



Credit: Wynand Steyn

congestion and ensure the safety of passengers and cargo. Such research will also affect related fields such as agriculture and logistics, where transporting food can be improved to reduce wastage or damage to fresh produce. The concept of digital twins of in-service infrastructure became one of the newer research themes, in conjunction with a host of other departments and faculties on campus.

The facility will become a place where novel ideas, scientific research, global expertise, students, academics, entrepreneurs and industry partners can meet to generate new thought leadership, innovation and training opportunities through collaborative partnerships.

The completion and handover of Engineering 4.0 on 28 February 2020 was followed by the first Covid-19 lockdown that severely affected the original plans for that year. The

official opening planned for 13 May 2020, was postponed until 30 November 2020 and several other adjustments needed to be made.

However, there were also positive unintended consequences of the delay, among which was the facility quickly becoming a base for the provision of various transdisciplinary activities at Innovation Africa @UP, offering, inter alia, a wide area wireless network that supports wireless sensors in facilities operated by EBIT, the Faculty of Natural and Agricultural Sciences (NAS) and the Forestry and Agricultural Biotechnology Institute (FABI), and hosting discussions ('Kindle the UP Fire') where leading thinkers of various faculties interact to discuss solutions to complex societal challenges, and potential solutions to such challenges through transdisciplinary collaborations.



## 7 | Unsettling Paradigms

Inspired by developments in the social movement for transformation in the higher education landscape since 2015, the project — ‘[Unsettling Paradigms: The Decolonial Turn in the Humanities Curriculum at Universities in South Africa](#)’ — has stimulated and strengthened work in the vital but under-researched field of curriculum transformation. With generous funding from the Mellon Foundation (R34 million), and led by the University of Pretoria and principal investigators Profs Vasu (V) Reddy and Maxi (M) Schoeman, this supra-institutional collaboration brought together eight research-intensive universities: Pretoria (UP), Witwatersrand (Wits), Free State (UFS), Rhodes (RU), Western Cape (UWC), Cape Town (UCT), KwaZulu-Natal (UKZN) and Stellenbosch (SU).

At an institutional level, the UP Senate approved the ‘[Reimagining curricula for a just university in a vibrant democracy](#)’ framework in May 2017<sup>9</sup>. The document highlighted four drivers for curriculum transformation:

- Responsiveness to social context
- Epistemological diversity
- Renewal of pedagogy and classroom practices, and
- An institutional culture of openness and critical reflection.

The nomenclature of the grant discloses a key focus and intention aligned to the strategic intervention at UP. If to *unsettle* means to alter from a settled state — to cause to be no longer firmly fixed or established — then we are undoubtedly living in times where our paradigms (assumptions, concepts, values and practices) have been called into question. Our received notions have been shaken, weakened and perhaps disturbed (in part by the student movement but also because the university is fundamentally an institution built on and defined by a larger project of change). It matters because universities have a moral obligation to instigate and create change. It benefits not just the institution but the country too and our location in the world.

The ‘decolonial turn’ explores how we produce new or different renditions of the humanities curriculum.

While decolonisation directs attention to a colonial (and apartheid) past and a postcolonial (post-apartheid) future, it simultaneously challenges structures of exploitation, inequalities and power. Decoloniality, in turn, pushes beyond the postcolonial (which exposed global Eurocentrism) towards the decolonial by directing the critique to the roots of epistemology (what we know and of ways of knowing) and ontology (who we are, our being).

Decoloniality challenges the dominating forces of monoculturalism, Eurocentricism and western epistemologies by surfacing the knowledge domain in the production of pluriversality and epistemic justice — in other words, the value of multiple voices and perspectives to make sense of the world we inhabit.

### A long-term view and framework

The intention of participating universities was to place the issue of curriculum transformation in the humanities centre-stage with a view to the long term. In other words, the core aim was that the original five-year programme and grant would be used in such a way as to ensure the longer-term sustainability of a transformation agenda; and further, that by strengthening knowledge, students will be empowered better to understand the dynamics of human and social behaviour at all levels.



<sup>9</sup> Framework developed by the Curriculum Transformation Workstream (April 2017); approved by Senate (May 2017, S4466/17).

The conceptual and organising frame of the programme was fourfold, viz.:

- *Recovery* — mapping curriculum change over time;
- *Reassessment* — an interrogation of canonical figures and themes within current syllabi to produce a decolonial epistemic perspective;
- *Repositioning* — curriculum transformation that aims to bring a more holistic understanding of the world in which we live; and
- *Praxis* — making the knowledge and insights gained meaningful and tangible in the interaction and collaboration with students.

Four discipline clusters informed the project: the core humanities, the core social sciences, the visual and performing arts and the applied social sciences.

Organised around 'theory and research', 'theory and teaching', and 'hidden curriculum and embedded practices', the themes served as thematic work clusters which incorporated the conceptual and organising frame:

- *Theory and research* focused on knowledge production from the global South, and decolonising research methodologies;
- *Theory and teaching* addressed students as participants (and co-creators) in knowledge production; and
- *The hidden curriculum* engaged influences at the level of organisational structure and culture found in the spaces, symbols, narratives and embedded practices that constitute the university and in the diversity, or lack thereof, of staff and student cohorts.

### **Achievement and anticipated outcomes**

Underlying and supporting the thematic work clusters was the development of an Open Online Knowledge Portal<sup>10</sup> which would serve as an archive and a repository of sources and resources to be used by all participating institutions and other tertiary institutions in South Africa, in order to share the knowledge and expertise generated by the partners. By 2018, the end of the review period, the portal had been developed and was ready to be populated with the resources and publications generated through this large-scale project.

The outcomes were planned to be a body of research *about*, and the result of, the decolonisation of the humanities

curriculum in South Africa. These outcomes were intended to include journal and book publications, a visual record (a documentary film), a number of postgraduate dissertations and theses, and a range of new curricula developed on the basis of the research conducted.

A significant achievement of this project was the establishment of a journal dedicated to decolonisation studies, the *Journal of Decolonising Disciplines (JDD)*, with Volume 1(1) published in 2019 as one of the first major outcomes of the project.<sup>11</sup> The administrative hub of this journal is in the Faculty of Humanities at UP.

The project also gave rise to another initiative that is rapidly growing in scope and size, viz. a press/publishing house, also at the University of Pretoria — the Emerging Scholars Initiative (ESI)<sup>12</sup> — dedicated to the publication of journals, monographs and edited volumes related to issues of transformation in a South African context or from a South African perspective. Initially, the press was aimed at assisting young and emerging scholars with a publication outlet, serving also as a writing school and mentoring young scholars to prepare them for aspects such as peer review, academic writing, reporting on research, with senior scholars (locally and abroad) serving as mentors and reviewers. Soon, though, it became clear that there was a wider demand for such a service.

### **Projects and partnerships planned**

There was a host of projects planned for the initial five-year timespan of the project, with several intended to branch out to include partnerships with historically disadvantaged South African universities.

To illustrate some of the ideas:

- In a collaborative initiative, the Philosophy Departments at Rhodes and Wits universities planned to redesign their Philosophy syllabi, strongly to focus on African philosophy, and continental and analytical philosophy from an African perspective.
- The universities of Kwa-Zulu Natal and the Free State initiated a joint project on multilingualism, and the University of the Free State established an Academy for Multilingualism inspired by transformation issues.
- At the University of KwaZulu-Natal, the first of a new summer school series focusing on 'Decolonising Knowledge and Power' was offered in 2019.

- At UP, the Faculty of Law established a university-wide curriculum transformation seminar series that provided an opportunity for scholars to share their experiences and insights regarding curriculum transformation.

It is quite clear that this intra-institutional project made, and continues to make, a huge contribution to the 'decolonial turn' and has a long-term impact for the very reason that it successfully created the opportunity for several South African universities firmly to embed the idea of 'curriculum transformation' in the humanities as part of an ongoing process.



<sup>10</sup> <https://www.up.ac.za/unsettlingparadigms>

<sup>11</sup> <https://upjournals.up.ac.za/index.php/jdd/issue/view/269>

<sup>12</sup> <https://esipress.up.ac.za>

## References

- Ally S et al. 2019. An open letter to the readers of Adam Habib's 'Rebels and Rage', Mail & Guardian, 1 April 2019. <https://mg.co.za/article/2019-04-01-an-open-letter-to-the-readers-of-adam-habibs-rebels-and-rage/> [Accessed: 22 July 2022].
- Anon, UP Vice-Chancellor is Businesswoman of the Year winner for Education, 11 September 2017. [https://www.up.ac.za/business-management/news/post\\_2556244-up-vice-chancellor-is-businesswoman-of-the-year-winner-for-education#:~:text=University%20of%20Pretoria%20\(UP\)%20Vice,ceremony%20in%20Sandton%20last%20week.](https://www.up.ac.za/business-management/news/post_2556244-up-vice-chancellor-is-businesswoman-of-the-year-winner-for-education#:~:text=University%20of%20Pretoria%20(UP)%20Vice,ceremony%20in%20Sandton%20last%20week.) [Accessed: 22 July 2022].
- Badsha N. 2016. Foreword. *Reflections of South African university leaders 1981 to 2014*. African Minds & Council on Higher Education, Cape Town.
- Badsha N and N Cloete N. 2011. Higher Education: Contribution for the NPC's National Development Plan. Unpublished paper.
- Benatar D. 2021. The fall of the University of Cape Town: Africa's leading university in decline, *Politicsweb*, pp.415-421.
- Castells M (ed). 2014. *Reconceptualising Development in the Global Information Age*. Oxford Academic online [Accessed 15 March 2023].
- Cloete N and Muller J. 1998. South African higher education reform: What comes after post-colonialism? *European Review* 6(04), 525-542, October 1998. DOI: 10.1017/S1062798700003653
- Cloete N et al. (eds). 2002 (and 2006). *Transformation in Higher Education: Global Pressures and Local Realities*. Springer.
- Cloete N. 2014. The South African higher education system: performance and policy. *Studies in Higher Education*, 39:8, 1355-1368, DOI: 10.1080/03075079.2014.949533.
- Council on Higher Education (CHE). 2000. Towards a new higher education landscape: meeting the equity, quality and social development imperatives of South Africa in the 21st century. Pretoria: CHE Shape and Size of Higher Education Task Team.
- CHE. 2016. *Reflections of South African university leaders, 1981 to 2014*. African Minds and CHE, Cape Town.
- CHE. 2011, 2016 & 2021. *VitalStats. Public Higher Education*. Pretoria.
- Department of Education (DoE). 1997. *White Paper 3. A programme for the transformation of higher education*. Pretoria.
- DoE. Higher Education Act 1997. Act No.101 of 1997. Pretoria.
- DoE. 2001. *National Plan for Higher Education*, February 2001. Government Gazette No.22138 (230).
- DoE. 2004. A New Funding Framework: How government grants are allocated to public higher education institutions.
- DoE. 2007. Implementation Manual for Annual Reporting by Higher Education Institutions (2nd edition); followed in 2014 by Government Notice No R464, in Gazette No 37726 of 9 June 2014.
- DoE. 2008. Report of the Ministerial Committee on Transformation and Social Cohesion and the Elimination of Discrimination in Public Higher Education Institutions, November 2008 (the 'Soudien Report').
- Department of Higher Education and Training (DHET). 2010. Revised Strategic Plan 2010/11 to 2014/15.
- DHET. 2010. Stakeholder Summit on Higher Education Transformation, 22-23 April 2010, Cape Peninsula University of Technology, Cape Town.
- DHET. 2013. Report of the Ministerial Committee on the Review of the Funding of Universities.
- DHET. 2013. *White Paper for post-school education and training: Building an expanded, effective and integrated post-school education system*.
- DHET. 2014. Policy framework on differentiation in the South African post-school system, July 2014.
- DHET. 2016. Report on the Second National Higher Education Transformation Summit: International Convention Centre, Durban, KwaZulu-Natal, 15-17 October 2015. Published January 2016.
- DHET. 2017. Ministerial Statement on the Implementation of the University Capacity Development Programme through Effective Management and Utilisation of the University Capacity Development Grant 2018-2020, released March 2017.
- DHET. 2020. Report on the Evaluation of the 2018 Universities' Research Output.
- De la Rey, C. 2010. Inaugural address, University of Pretoria, 15 April 2010.
- Dentlinger L. 2018. #FeesMustFall damage costs soar to nearly R800m, *Eyewitness News*, 8 August 2018.
- eNCA. 2015. 'Security runs for cover as Tuks students protest.' 21 October. [Online] Available at <https://www.enca.com/south-africa/security-runs-cover-students-protest> [Accessed 20 March 2023].
- Griesel H. 2013. Differentiation at UP — a compilation of uses and ideas. University of Pretoria, February 2013. Unpublished paper.
- Hendricks D and Flaherty J. 2018. Integrating the Edges: University of Pretoria's neighbourhood anchor strategy, *Development Southern Africa*, 35:5, 689-700, DOI: 10.1080/0376835X.2018.1433024
- Habib A. 2019. *Rebels and Rage: Reflecting on #Feesmustfall*. Jonathan Ball Publishers, Johannesburg.
- Jansen J. 2001. Does the national plan effectively address the critical issues facing higher education? *SA Journal of Higher Education*, Vol 15(3), 5-9.
- Jansen J. 2017. *As by fire: The end of the South African university*. Tafelberg, Cape Town.
- Keet A. 2015. Briefing paper prepared for the second national Higher Education Transformation Summit, 15-17 October 2015.
- Lange L. 2014. Rethinking Transformation and Its Knowledge(s): The Case of South African Higher Education. *Critical Studies in Teaching & Learning*, Vol2(1), p.6. DOI: 10.14426/cristal.v2i1.24.
- Lange L and Luescher-Mamashela T. 2016. Governance. *South African Higher Education Reviewed: Two decades of democracy*, pp.105-141. CHE, Pretoria.
- Lange L. 2020. Transformation Revisited: Twenty Years of Higher Education Policy in South Africa, Chapter 3, in I Rensburg, S Motala and M Cross (Eds), *Transforming Universities in South Africa: Pathways to Higher Education Reform. African Higher Education: Developments and Perspectives*, Vol 6. Brill.
- Luescher TM. 2007. Higher education and the substantiation of democracy in South Africa. Report on the research seminar of the Higher Education Institutional Autonomy and Academic Freedom (HEIAAF) Task Team. Johannesburg.
- Luiz JM. 2009. Evaluating the performance of South African Economics Departments. *South African Journal of Economics*, November 2009. <https://doi.org/10.1111/j.1813-6982.2009.01228.x>
- Makhetha T and Moatshe R. 2015. 'Fees fight hits city'. Pretoria News, 22 October, p.1.
- Maluleke T. 2015. 'Towards an African Strategy for the University of Pretoria.' Report prepared for the UP Africa Strategy (UPAS) reference group appointed by the Vice-Chancellor. July 2015.
- Maluleke T. September 2017. Towards a Framework for the Transformation of Institutional Culture at UP.
- Mouton FA. 2004. FJ du Toit Spies, Afrikaner Nationalism and *Volksgeskiedenis* at the University of Pretoria, *South African Historical Journal*, 51(1).
- Mouton J et al. 2018. *The Silent Majority*. A study commissioned by the Department of Science and Technology on building a cadre of emerging scholars for higher education in South Africa. Pretoria.
- Mouton J et al. 2019. The Quality of South Africa's Research Publications. Pretoria.
- Muller J et al. (eds). 2017. *Castells in Africa: universities and development*. African Minds, Cape Town.
- National Commission on Higher Education (NCHE). 1996. A Framework for Transformation. Pretoria.
- National Planning Commission. 2013. *National Development Plan — Vision for 2030*. The Presidency.
- O'Connell S. 2022. UP can stake its place as a benchmark space of higher learning in, and of, Africa. In M Crewe (ed.), *Institutional Curiosity*. ESI Press, Pretoria.
- OECD. 2007. *Reviews of Innovation Policy: South Africa* [<https://doi.org/10.1787/9789264038240-en>].
- OECD. 2008. *Reviews of National Policies for Education: South Africa* [<https://doi.org/10.1787/19900198>]

- Presidency. 2015. Report of the Presidential Task Team on Short-Term Student Funding Challenges at Universities, November 2015.
- Presidency. 2017. Report of the Commission of Inquiry into Higher Education and Training. August 2017.
- Rensburg I, Motala S and Cross M (eds). 2020. Transforming Universities in South Africa: Pathways to Higher Education Reform. *African Higher Education: Developments and Perspectives*, Vol 6. Brill.
- Sharp PA and Leshner AI. 2014. Meeting global challenges. *Science*, 343: 579.
- Singh M. 2001. Re-inserting the 'public good' into higher education transformation. *Kagisano Dialogue Series*, No1, 8-18. Council on Higher Education, Summer 2001.
- Slippers B, Vogel C and Fioramonti L. 2015. Global trends and opportunities for development of African research universities. *South African Journal of Science*, 111(1-2): 1-4. <https://dx.doi.org/10.17159/sajs.2015/a0093>
- Smith ET. 2021. Education and the public good: Foregrounding education in history, *Yesterday & Today*, 26, December 2021.
- Stumpf R. 2013. University of Pretoria: Project on internal differentiation as a way of achieving the University's strategic goals for 2025. An implementation framework.
- University of Pretoria. 2022. *Institutional Audit Self-Evaluation Report*. May 2022. Pretoria.
- World Social Science Report. 2013. *Knowledge Divides. Summary*, June 2013. A joint report of UNESCO and the International Social Science Council (ISSC).
- Zuma-Dlamini N. 2014. 'Research Universities and African development.' Lecture delivered at the University of Pretoria, 24 April 2014.

## UP POLICIES and documents

- Strategic Plan of the University of Pretoria, 2007–2011. *The Innovation Generation: Creating the Future*.
2010. Global University: Report to the Executive by the Task Team to Develop an Internationalisation Strategy (August 2010).
2010. Performance Indicators, May 2010.
2010. Group 4 Report, SWOT analysis, prepared for the development of UP's long-term strategy, November 2010.
2011. Planning Committee Consolidated Report: Developing UP's Strategic Plan 2025.
2011. Strategic Plan: the vision, mission and plan of the University of Pretoria for 2025. [Rt 673/11]
2011. Five-year Implementation Plan. [Rt 82/12]
2012. Academic Plan, January 2012
2012. UP Journey for Change.
2014. UP submission to the South African Human Rights Commission. 1 August 2014.
2015. Research excellence from Mamelodi to Cairo. Scholarship from Africa to Africa.
2016. Reports of the Independent Transformation Panel of UP Council, June and November 2016.
2016. UP Strategic Plan 2017–2021. November 2016 [R38/16]
2017. UP Institutional Plan and Budget. [R 40/16]
2017. Framework developed by the Curriculum Transformation Workstream [S4466/17]
2017. Transformation Implementation Plan, August 2017 [Rt 478/17]
- 2011 to 2019. UP Annual Reports.
2018. Department of Education Innovation. Annual Report.

# Appendices

Appendix A   UP 2025	539
Appendix B   UP Chancellor's Medal	540
Appendix C   Honorary Doctorates	540
Appendix D   Members of UP Council and Chairpersons	541
Appendix E   UP Executive	542
Appendix F   Institutional Forum	546
Appendix G   Student Representative Council	548
Appendix H   UP Academic Achievers' Awards	551
Appendix I   Student Residences	555
Appendix J   Information Design Student Competition	556

## Appendix A | UP 2025

### Vision, Mission and Values

#### Vision

*To be a leading research-intensive university in Africa, recognised internationally for its quality, relevance and impact, and also for developing people, creating knowledge and making a difference locally and globally.*

#### Mission

*In pursuing recognition and excellence in its core functions of research, teaching and learning, and integrating engagement with society and communities into these, the University of Pretoria will use quality, relevance, diversity and sustainability as its navigational markers.*

#### Values

*The members of the University of Pretoria believe that—*

- *our community of scholars must be founded on the pursuit of knowledge through research, and teaching and learning, with membership acquired on the basis of intellectual merit, ability and the potential for excellence; and that*
- *differing perspectives, arising from diverse backgrounds and histories that define our identities, deepen scholarly inquiry and enrich academic debate.*

*We cherish—*

- *academic freedom, creative and innovative thought, ethical standards and integrity, accountability and social justice; and*
- *our staff and students as the University's core asset.*

*We foster—*

- *an inquiry-led and evidence-based approach to creating knowledge; and*
- *academic citizenship, whereby we commit ourselves to harnessing our intellectual abilities in the interest of our nation and humanity.*

*We recognise that—*

- *in a resource-constrained world where vast disparities remain, the University must endeavour to produce graduates who appreciate the importance of community service, entrepreneurial endeavours and innovative actions in generating employment and development in our local communities.*

## Appendix B | UP Chancellor's Medal

YEAR	FACULTY
<b>2009</b>	
Fay King (FK) Chung	Education
Hendrik Nicolaas (HN) van der Merwe	Health Sciences
Edna Adan (EA) Ismail	Law
<b>2010</b>	
Henry Langazye (HL) Kaluba	Education
Shalati Joseph (SJ) Khosa	Humanities
<b>2011</b>	
Senyani Noria (SN) Mabasa	Humanities
Sandra (S) Prinsloo	Humanities

YEAR	FACULTY
<b>2014</b>	
Francois Stephanus (FS) Malan	Health Sciences
<b>2015</b>	
Thabo Cecil (TC) Makgoba	Theology and Religion
Reverend Frederick (F) Swanepoel	Theology and Religion
<b>2017</b>	
Imtiaz Ismail (II) Soliman	Humanities
Pieter Gerhard Jacobus (PGJ) Meiring	Theology and Religion
<b>2018</b>	
Tobie Jurgens (TJ) Cronjé	Humanities

## Appendix C | Honorary Doctorates

YEAR	FACULTY
<b>2009</b>	<b>FACULTY</b>
Prof Peter (S) Salovey	Education
Prof Kenneth Andrew (KA) Eriksson	NAS
Prof Mark Lee (ML) Savickas	Education
Prof James Alfred (JA) Loader	Humanities
Prof Navanethem (N) Pillay	UP Law
Prof Ojelanki Kayana (OK) Ngwenyama	EBIT
Prof Theunis Willem (TW) Naudé	Veterinary Science
<b>2010</b>	
Prof Stephen George Frederick (SGF) Hall	EMS
Prof Ralph Dennis (RD) Mawdsley	Education
Prof Kumbakonam Ramamani (KR) Rajagopal	NAS
Prof Peter Hans (PH) Pauly	EMS
Prof Rudi (R) van Eldik	NAS
Prof William Augustus (WA) Jesser	NAS
Prof Elias (E) Mpofu	Education
<b>2011</b>	
Lord Christopher Francis (CF) Patten	GIBS
Prof James William (JW) Schopt	NAS
Frans Heinrich (FH) Grosskopf	UP Law
Dr Frederick Bernard (FB) Cohen	EBIT
Katinka (K) Heyns-Barnard	Humanities
Advocate George (G) Bizos	UP Law
Prof Philomena Johanna Maria Essed	Education

YEAR	FACULTY
<b>2012</b>	
Prof Klaus Bilfried (KB) Nürnberger	Theology and Religion
Prof Pieter Schalk (PS) Groenewald	Humanities
Prof Santosh Madhava (SM) Warriar	NAS
Prof Beric William (BW) Skews	EBIT
Prof Carol Diane (CD) Lee	Education
Sir Terence Orby (TO) Conran	EBIT
<b>2013</b>	<b>FACULTY</b>
Prof Njabulo Simakahle (NS) Ndebele	Humanities
Prof Solomon Johannes (SJ) Terreblanche	EMS
Prof Johann Vincent (JV) van der Westhuizen	UP Law
Prof Timothy Hugh (TH) Clutton-Brock	NAS
<b>2014</b>	
Prof Tjeerd (T) Plomp	Education
Prof Richard Lee (RL) Baskerville	EBIT
Prof John (JW) Creswell	Education
Ben (B) Okri	Humanities
<b>2015</b>	
Prof Jan (J) de Groof	Education
Prof Karl Ernest (KE) Klare	UP Law
Prof Marco (M) Dorigo	EBIT
Prof Howard (H) Alper	NAS
Prof Sergej (S) Zilitinkevich	NAS
Prof David Joseph (DJ) Padilla	UP Law
Prof Adrian (A) Bejan	EBIT

<b>2016</b>	
Prof Theo Hermann Otto (THO) Sundermeier	Theology and Religion
Prof Arne Axel Göran (AAG) Therborn	Humanities
Prof Zoe Charlotte (ZC) Wicomb	Humanities
Prof Willem Andre (WA) Maria	Theology and Religion
<b>2017</b>	
Prof Jürgen Dankwart (JD) Moltman	Theology and Religion
Prof Jean (J) Clandinin	Education

<b>2018</b>	
William (W) Kentridge	Humanities
Prof Emmanuel Yartekwei (EY) Lartey	Theology and Religion
Michael Paul (MP) van Graan	Humanities
Prof Romila (R) Thapar	Humanities
Prof József István (JI) Karger-Kocsis	EBIT
Prof John Seargeant (JS) Kloppenborg	Theology and Religion
Prof Ben Abraham (BA) Shneiderman	EBIT

## Appendix D | Members of UP Council and Chairpersons

COUNCIL MEMBERS	
<b>Nominated by the Minister</b>	
Boni (B) Dibate	October 2000–March 2012
Dr Pamela (PZ) Dube	March 2008–March 2012
Thoko (NFT) Mpumlwana	March 2008–March 2012
Dr Barbara-Ann (BJ) Ribeiro	January 2004–(beyond 2018)
Allan (AW) Taylor	March 2008–
Kuseni (K) Dlamini	July 2012–
Neo (N) Lesela	June 2012–
Vuyelwa (V) Qinga	May 2013–
<b>Elected by Convocation</b>	
Anton (AD) Botha	October 2000–
Dr Piet (BP) Botha (Deputy Chairperson)	October 2004–October 2012
Dr Liesbeth (EC) Botha	October 2008–October 2012
Dr Johan (J) van Zyl	January 2004–November 2011
Prof Danie (DP) Goosen	October 2012–February 2013
Prof Appie (AJ) Pienaar	October 2012–
Willie (WD) Spies	October 2012–April 2017
Dr Danie (DM) Behr	September 2013–
Kedibone (KP) Diale	July 2017–
<b>Elected by Senate</b>	
Prof Carolina (C) Koornhof	May 2008–May 2012
Prof Thanyani (TJ) Mariba	May 2007–May 2011
Prof Anton (A) Ströh	October 2007–September 2011
Prof Innocent (I) Pikirayi	2012–
Prof Roelf (RF) Sandenbergh	2012–September 2014
Prof André (A) Boraine	October 2014–
Prof Sunil (BTJ) Maharaj	October 2014–
<b>Elected by Donors</b>	
Laurie (LL) Dippenaar	October 2000–
Prof Dion (DJ) du Plessis	October 2006–August 2012

Dr Piet (BP) Botha	October 2012–May 2018
<b>Members appointed by Council based on expertise/experience</b>	
Dr Willem (WJ) Barnard	August 1999–June 2012
Dr Steve (SF) Booysen	February 2005–November 2018
Russell (R) Loubser	March 2007–
Danai (D) Magugumela	June 2008–
Futhi (NT) Mtoba (Chairperson)	February 2005–
Israel (IB) Skosana	March 2007–
Dr Johan (J) Van Zyl	November 2011–November 2018
<b>Members appointed by the Tshwane local authority</b>	
Subesh (S) Pillay	July 2001–December 2003; April 2006–
Petunia (P) Mashaba	March 2010; August 2016 (resigned)
Cilliers (C) Brink	October 2011–October 2014; October 2016–
<b>Student members appointed by the SRC</b>	
Hector (H) Beyers	January 2008–December 2009
Ivor (I) Mokwena	January 2008–December 2009
Charl (C) Oberholzer	January 2009–December 2011
Katlego (K) Malatji	January 2010–December 2011
Mthokozisi (M) Nkosi	January 2012–December 2012
Gerbrand(G) Lindeque	January 2012–December 2012
Luyolo (J) Dulaze	January 2013–October 2013
Jordan (J) Griffiths	January 2013–October 2013
Enwee (E) Human	October 2013–December 2014
Taymoon (T) Mohammed-Altamash	October 2013–December 2014
Marna (M) de Jager	January 2015–January 2015
Mosibudi (M) Rasethaba	January 2015–January 2015
Nomtha (N) Gobe	January 2016–December 2016
Luvuyo (L) Menziwa	September 2016–suspended as SRC
Henrico (H) Bernard	January 2017–December 2017

Thabo (T) Shingange	January 2017–December 2017
Soraia (S) Machado	January 2017–December 2018
Kwena (K) Moloto	January 2017–December 2018
<b>Employee members (academic) elected by academic employees</b>	
Prof Henk (JH) Potgieter	May 2008–May 2012
Prof Maxi (MME) Schoeman	October 2013–October 2017
Prof Vasu (V) Reddy	November 2018 and beyond
<b>Employee members (non-academic) elected by non-academic employees</b>	
Prof Annél (A) van Aswegen	April 2004–May 2012
Dr Sanette (S) Boshoff	June 2012–June 2016
Jane (LJ) Mnguni	November 2018–

<b>UP Executive: Principal and Vice-Principals (ex officio)</b>	
Prof Cheryl (CM) de la Rey (Vice-Chancellor and Principal)	November 2009–December 2018
Prof Robin (RM) Crewe (Vice-Principal)	September 2003–February 2013
Prof Chris (CR) de Beer (Vice-Principal)	June 1995–February 2013
Prof Ramaranka (RA) Mogotlane (Vice-Principal)	September 2001–30 June 2010
Prof Nthabiseng (NA) Ogude (Vice-Principal)	October 2006–July 2012
Prof Stephanie (SG) Burton (Vice-Principal)	January 2011–2018 and beyond
Prof Johan (JC) Engelbrecht (acting Vice-Principal)	August 2012–April 2013
Prof Tyrone (TB) Pretorius (Vice-Principal)	May 2013–August 2014
Prof Themba (NT) Mosia (Vice-Principal)	May 2013–2018 and beyond
Prof Norman (NTF) Duncan (Vice-Principal)	August 2014–2018 and beyond
Prof Anton (A) Ströh (Vice-Principal)	August 2014–2018 and beyond

## Appendix E | UP Executive

A chronology of individuals who formed part of the UP Executive team, and their respective terms of office and portfolios, is summarised below. The names of individuals who worked in their offices are also given.

### VICE-PRINCIPALS

#### **Prof Chris (CR) de Beer | Senior Vice-Principal**

Prof De Beer's portfolio included internal and academic affairs, resource allocation, student affairs and residences, human resources and strategic projects.

In April 2011, the Minister of Higher Education and Training seconded Prof De Beer to the University of Zululand as Administrator initially for a one-year period, extended to October 2013. His secondment necessitated temporary changes to the portfolios of Executive members. Prof Robin Crewe was appointed as Acting Senior Vice-Principal. Duties relating to Student Affairs and Residences were shared between Prof Ogude and Prof Grové. Following his secondment to UniZulu, Prof De Beer was seconded to the Department of Higher Education and Training (DHET) in a part-time capacity to work on several high-level projects. He continued to work on UP projects until his retirement in July 2014.

Desirée Homann (later Dr Desirée Tesner-Smith) provided support in the capacity as executive assistant.

#### **Prof Ramaranka (RA) Mogotlane | Vice-Principal: Academic**

Prof Mogotlane joined UP as Advisor to the Principal in 2001, after the end of his term as Vice-Chancellor at the Medical University of South Africa (Medunsa). He was appointed Vice-Principal: Academic in 2001 and pioneered the University's Community Engagement thrust. While he was responsible for all faculties, he had a particular affinity for his home faculty, namely Health Sciences and the School of Medicine. In May 2010, Prof Mogotlane return to academia and practice in the field of medicine. In 2011, Senate approved that he be named Vice-Principal Emeritus. Sadly Prof Mogotlane passed away in October 2019.

Petro Cronje was the executive assistant in his office.

#### **Prof Robin (RM) Crewe | Vice-Principal: Research**

Prof Crewe, former Dean of the Faculty of Natural and Agricultural Sciences, held the position of Vice-Principal: Research from 2003. As a respected senior academic, he continued his research and upheld his NRF B rating, in spite of a heavy managerial workload. His institutional responsibilities as Vice-Principal focused on promoting and supporting research at the University, with line responsibility for Library Services, the Department of Research and Innovation Support, technology transfer, Corporate International Relations and GIBS.

His appointment as Vice-Principal was extended until his retirement in June 2012. However, in view of the secondment of Prof De Beer at the behest of the Minister and DHET, Prof Crewe's appointment was extended for a further year until June 2013, to assume the role of Acting Senior Vice-Principal. In June 2013, he was appointed as the Director of the Centre for the Advancement of Scholarship until the end of 2016.

Prof Crewe was supported by Alta Scheepers throughout his term on the Executive team.

#### **Prof Nthabiseng (NA) Ogude | Vice-Principal: Teaching and Learning**

Prof Ogude, who had joined the University of Pretoria in 2006, was reappointed as Vice-Principal: Teaching and Learning for a second term in 2010. Her portfolio included responsibility for teaching and learning in all faculties, the Department of Education Innovation, and the cross-cutting theme of transformation. Prof Ogude also attended to the Student Affairs portfolio for a period during the secondment of Prof De Beer to the University of Zululand. In 2012, Prof Ogude resigned to accept the appointment as Vice-Chancellor and Principal at the Tshwane University of Technology (TUT). She returned to UP in the role of Dean: Mamelodi Campus in August 2016.

Prof Johann (JC) Engelbrecht, former Deputy Dean in the Faculty of Natural and Agricultural Sciences, was appointed as Acting Vice-Principal: Academic from August 2012 to take over the duties of Prof Ogude until such time as the position could be filled.

Lenie van Zyl was the executive assistant, while Michelle Viljoen provided support linked to student affairs.

#### **Prof Stephanie (SG) Burton | Vice-Principal: Research and Postgraduate Studies**

Prof Burton was appointed as Vice-Principal: Research and Postgraduate Studies in April 2011. Her portfolio included responsibility for research and postgraduate studies across all faculties, the Department of Library Services, the Department of Research and Innovation Support, Corporate International Relations and GIBS. For a period, her portfolio also had line responsibility for the Department of University Relations (renamed the Department of Institutional Advancement). Prof Burton's reappointment for a second term was approved in November 2015. From 2018, her executive responsibility included the Future Africa research platform. She was still Vice-Principal at the end of the review period.

Petro Cronje was the executive assistant in Prof Burton's office until her retirement in 2018, when Doris Hlongwane was redeployed to the position.

#### **Prof Tyrone (TB) Pretorius | Vice-Principal: Academic**

Prof Pretorius, former Deputy Vice-Chancellor of the University of the Western Cape (UWC) and Pro Vice-Chancellor of Monash University SA, was appointed as Vice-Principal: Academic from May 2013. He took over responsibility for teaching and learning and the Department of Education Innovation. The nine faculties and GIBS reported to Prof Pretorius. He also had a keen involvement in sport at UP and was given responsibility for institutional planning and resource allocation in January 2014. He left UP in August 2014 to take up the position of Vice-Chancellor and Principal of the University of the Western Cape.

Hester Jacobs was the executive assistant to Prof Pretorius; Dr Desirée Tesner-Smith provided support in the capacity as senior executive assistant, and Maliga Govender as senior administrative control officer.

#### **Prof Themba (NT) Mosia | Vice-Principal: Student Affairs**

Prof Mosia was appointed as Vice-Principal: Student Affairs and Residences in 2013. His portfolio included line responsibility of the Department of Student Affairs and the Department of Residence Affairs and Accommodation. In the period preceding his appointment, the reporting lines of these two departments had been split between different members of the Executive team due to the extended secondment of Prof Chris de Beer. In April 2016, the DHET and Department of Justice requested the secondment of Prof Mosia to the Presidential Commission of Inquiry into long-term university funding, led by Justice Jonathan Arthur Heher. During this period of secondment, the portfolio was split. Prof Grové was made responsible for Residence Affairs and Accommodation, while the Student Affairs reporting line was transferred to Prof Carolina Koornhof. When Prof Mosia returned from his secondment in 2017, the portfolio and staff reporting lines were restored.

Thanyani Malange, former secretary to the Dean of Humanities, was appointed as executive assistant in Prof Mosia's office in 2013; at the same time, Michelle Viljoen was transferred to his office as senior executive assistant.

#### **Prof Norman (NTF) Duncan | Vice-Principal: Academic**

Prof Duncan, former Dean of the Faculty of Humanities, was appointed as Vice-Principal: Academic from August 2014. He was responsible for overseeing teaching and learning in all faculties and the Department of Education Innovation at a strategic institutional level. Prof Duncan was appointed for a second term in 2018 and remained in the position of Vice-Principal: Academic beyond the review period.

Hester Jacobs was the executive assistant in his office, and Maliga Govender the senior administrative control officer. When Ms Jacobs retired in 2016, after 42 years at UP, Thembelihle Sibiyi was appointed as executive assistant.

#### **Prof Anton (A) Ströh | Vice-Principal: Institutional Planning**

Prof Ströh, a proud UP alumnus and former Dean of the Faculty of Natural and Agricultural Sciences, was appointed as Vice-Principal: Institutional Planning in August 2014. His portfolio included responsibility for institutional planning, forecasting, business intelligence and quality assurance, and also resource allocation.

Anoinette Auret served briefly as temporary secretary until the appointment of Ragni Chetram. In 2015, Desirée Homann (later Dr Desirée Tesner-Smith) served as senior executive assistant. Following the restructuring of the Department of Academic Administration and the Client Services Centre, Dr Dawie Marais worked in Prof Ströh's office for a period.

#### **EXECUTIVE DIRECTORS**

##### **Prof Sibusiso (S) Vil-Nkomo | Advisor and Executive Director**

Prof Vil-Nkomo, previously Dean of the Faculty of Economic and Management Sciences, was appointed as Advisor to the Vice-Chancellor and Principal in 2009, and subsequently as the Executive Director for Community Engagement. His portfolio included the Mamelodi Campus for a period. Wishing to resume his academic career, Prof Vil-Nkomo was appointed as a research fellow in the Centre for the Advancement of Scholarship in 2011.

Martie Marneweck served as executive assistant to Prof Vil-Nkomo.

##### **Prof Antony (AP) Melck | Executive Director: Institutional Planning**

Prof Melck, previously Vice-Chancellor and Principal of Unisa, was appointed as Advisor to the UP Vice-Chancellor and Principal from 2001 to 2009, followed by the appointment as Executive Director responsible for institutional planning and finance. As Executive Director, Prof Melck also had direct line responsibility for the Bureau for Institutional Research and Planning, Academic Planning, Quality Assurance, Risk Management and Internal Audit as well as the Department of UP Arts. Prof Melck's responsibility for financial management and the budget was transferred to Prof Koornhof when she was appointed in April 2011.

Before his retirement in 2013, Prof Melck negotiated a donation of R50 million from the Javett Family Charitable Trust for the

establishment of a new UP Art Centre, and R25 million operating capital for the first ten years, as well as a permanent loan of artworks estimated at R45 million to assist the University in its mission of furthering the arts in South Africa.

Prof Melck was supported by Doris Hlongwane (formerly Ramuki) as executive assistant during his entire term at the University of Pretoria.

##### **Prof Antonie (AM) de Klerk | Executive Director: Infrastructure and Sport**

Prof De Klerk served as Executive Director from 2004 until July 2015. The Departments of Information Technology Services and Facilities Management, TuksSport, the hpc, Sports Companies and Procurement, a division in the Department of Finance, formed part of his portfolio. Prof De Klerk retired from the University at the end of 2017.

Lizzy Mmusi, former secretary to the Dean of Health Sciences, was the executive assistant in the office of Prof De Klerk during his term on the UP Executive.

##### **Prof Caroline (C) Koornhof | Executive Director: Finance**

Prof Koornhof, former Dean of the Faculty of Economic and Management Sciences, was appointed as Executive Director: Finance and Business Activities with effect from April 2011. Her reappointment for a further term as Executive Director was approved in November 2015. In 2017, the portfolio was changed with the addition of the Department of Enrolment and Student Administration (DESA). Prof Koornhof also assumed responsibility for the Student Affairs portfolio during the absence of Prof Mosia due to his secondment in 2016/2017.

Martiza Swartz was appointed as executive assistant to Prof Koornhof. She was succeeded by Verna Malan in August 2012. In 2018, Linda Pelsler was transferred from the Office of the Registrar to Prof Koornhof's office as executive assistant.

##### **Patience (P) Mushungwa | Executive Director: Human Capital and Transformation**

The University's development of a human capital development framework, pipeline and plan prioritising people development and institutional transformation initiatives resulted in the approval of a dedicated post at Executive level, and the appointment of an Executive Director: Human Capital and Transformation. Patience Mushungwa was appointed as Executive Director with effect from January 2012 and completed a five-year term in December 2017.

Martie Marneweck was the executive assistant in Ms Mushungwa's office until her retirement in 2015. She was succeeded by Doris Hlongwane (formerly in Prof Melck's office).

#### **REGISTRARS**

##### **Prof Niek (NJ) Grové | Registrar, 2009–2017**

Prof Grové, a UP alumnus, was Registrar for 18 years until 2017 when he returned to full-time academia in the Faculty of Law. In addition to his duties as Registrar, and subsequent to the secondment of Prof De Beer in 2011, and the appointment of Prof Mosia in 2013, Prof Grové also had line responsibility for Residence Affairs and Accommodation. This portfolio was returned to him temporarily from 2016 to 2017 during the secondment of Prof Mosia to the Heher Commission.

In August 2013, the Registrar was designated as Deputy Chief Information Officer of the University. This was followed by the transfer of the Information Governance portfolio, managed by Janine Esterhuizen, to the Office of the Registrar, from January 2014. At the time reporting was assigned to the Client Service Centre under Dr Karen Lazenby. The reporting line of the Manager: Information Governance was changed to report directly to the Registrar, Prof Caroline Nicholson from January 2018.

##### **Prof Caroline (CMA) Nicholson | Registrar, 2018 and beyond**

Prof Nicholson was appointed as Registrar from 1 January 2018. Elana Van Vreden served as senior executive assistant to both Registrars. Shirley Motea was appointed as the executive assistant in the Office of the Registrar in 2016.

#### **THE OFFICE OF THE VICE-CHANCELLOR AND PRINCIPAL**

During her term as Vice-Chancellor and Principal, Prof De la Rey was assisted by Diana Cochrane-Van Eeden (senior executive assistant, April 2007), and Elmarie Cronjé (executive assistant, June 2011). Kgomotso Legari joined the Office in 2010 until his appointment as the Deputy Director of Residence Affairs and Accommodation in 2013. In the same year, Prof Annél van Aswegen, former Director: Human Resources at the University, was appointed as senior office manager, a position she held up to her retirement in 2017. Prof Somarie Grey preceded and overlapped with this core group. She was the executive project coordinator, a position she held from 2005 to 2010, followed by her appointment as researcher until the end of 2012.

This engine room of the University, perhaps more than any other, requires staff with a specific disposition and demeanour. At the

Hatfield campus retirement function of Prof De la Rey, held on 26 November 2018 at the Aula, she singled out four people to thank: her husband, Eldridge Johnson — and Diana Cochrane-Van Eeden, Elmarie Cronje and Annél van Aswegen.

Prof Tinyiko (ST) Maluleke, professor in the Faculty of Theology, was seconded to the Executive as Advisor to the Vice-Chancellor and Principal from 1 April 2016 to 31 March 2018. He played a direct role in improving internal and external communications, and engaging with student political groupings, the SRC and internal and external stakeholders.

Prof Maluleke was supported by Lizzy Mmusi as secretary and on a temporary basis, by Lerato Kobe as research assistant, and Michelle Viljoen as senior executive assistant (in 2016/2017).

#### **FURTHER APPOINTMENTS**

In addition to core staff in the Vice-Chancellor's office, there were a number of short-term appointments to assist with specific projects:

Hanlie Griesel (Institutional research, 2013/2014); Prof Karel Stanz (Insourcing, 2016); Justice Johan van der Westhuizen (Independent Task Team on Transformation, 2016); Mike Frankel (Security Advisor for 2016/2017); Prof Eric Buch (Project Coordinator: Corporate Health and Well-being, 2017/2018); Prof Denver (DJ) Hendricks (Manager: Government Relations and Special Projects, 2018); Prof Quintus Vorster (Project Coordinator: Harmonisation of Insourced Staff, 2016); Prof Annél van Aswegen (Project Coordinator: Javett-UP Art Centre, 2018); Shireen Chengadu (Special Projects, 2018) and Mikateka Mbambo (part-time assistant in 2018). Lizzy (EM) Mmusi, secretarial assistance to Profs Buch, Hendricks, Stanz and Vorster.

In 2018, Prof Linda van Ryneveld was seconded for a special project on Comprehensive Online Education, reporting to the Vice-Principal: Academic, Prof Norman Duncan.

Individuals were appointed under Prof Anton Ströh, Vice-Principal: Institutional Planning, in 2017 and 2018: Dr Kirstin van Niekerk was seconded to the Strategy Execution Office in 2017. Bonnie Olivier was appointed on a one-year contract from 2017 to 2018 for Special Projects: Land Development.

In the Office of the Registrar, Dr Jakkie Pretorius was appointed as Programme Director: Business Continuity from 2016. Prof Denver (DJ) Hendricks was appointed as Manager: Office of Government Relations and Special Projects from 2016.



## Appendix F | Institutional Forum

<b>Chairperson</b>	
2009–2011	Prof Chris (CR) de Beer
2011	Prof Niek (NJ) Grové
March to June 2012	Prof Nthabiseng (NA) Ogude
2013–2016	Patience (P) Mushungwa
2017–2019	Prof Tinyiko (T) Maluleke
2009–2018 and beyond	Dr Desirée (D) Tesner-Smith, Secretariat
<b>Executive</b>	
Prof Niek (NJ) Grové (2009–2019), Deputy Chairperson (2012–2013)	
Ms Patience (P) Mushungwa (2012–2015)	
Prof Tinyiko (T) Maluleke (2012–2015)	
Prof Caroline (CMA) Nicholson (2011–2015; 2017–)	
<b>Council</b>	
Prof Pamela (PZ) Dube (2009–2012)	
Dr Liesbeth (EC) Botha (2009–2013)	
Petunia (P) Mashaba (2008–2012)	
Dr Sanette (S) Boshoff (2009–2013), Deputy Chairperson (2013–2016)	
Neo (N) Lesela (2014–2018)	
Prof Innocent (I) Pikirayi (2016–2020), Deputy Chairperson (2016–2020)	
<b>Senate</b>	
Prof Christof (CH) Heyns (2009–2011)	
Prof Cas (CJA) Vos (2009–2019)	
Prof Jerry (J) Mojalefa (2010–2014)	
Prof Dirk (D) Human (2011–2015, 2015–2019)	
Prof Jean (J) Lubuma (2011–2014, 2016–2019)	

### Members of the Student Representative Council

<b>2009</b>
Hector (H) Beyers
Charl (C) Oberholzer (2009, 2011)
Elsje (E) Blignaut
Lelanie (L) De Kock
Zwelakhe (Z) Mahuhleni (2009–2010)
Lebogang (L) Motswenyane
Annézel (A) Otto
Rozaan (R) Steenkamp
Nerima (N) Were
<b>2010</b>

<b>Alumni</b>
Jan (J) van Deventer (2009–2011)
Cornelius (C) Jansen van Rensburg (2012–2014)
Hinner (HH) Köster (2014–2016; 2018 and beyond)
<b>Persons with Disabilities</b>
Simon (SW) Mahlangu (2009–2012)
André (A) Kleynhans (2014–2022)
<b>Member appointed at the discretion of Council</b>
Prof McGlory (MT) Speckman (2009–2011)
Prof Jean (JMS) Lubuma (2015)
<b>NEHAWU</b>
Dr Dan (D) Thokoane (2009)
Obed (O) Moela (2010–2011)
Selokelo (S) Rathapane (2011–2015)
Jacob (J) Mphse (2011–2015)
Selena (S) Davids (2016–2017)
Goitsewang (G) Mathekga (2018 and beyond)
<b>UPWO</b>
Johan (JC) Jacobs (2009–2011)
Chris (H) Hattingh (2011–2018)
<b>UPSA</b>
Prof Leon (L) Maree (2009)
<b>APSA</b>
Eugene (E) Maluleke (2018 and beyond)
Lindiwe (L) Mnguni (2018 and beyond)

Awie (A) Erasmus
Mario (M) Fasondini
Armand (A) Goutondji
Natasha (N) Gresse
Megan (M) Howard
Nyasha (N) Kuzinya
Zwelakhe (Z) Makuhleni
Hanri (H) Niemand
Michael (M) Shackleton
Tiyani (T) Sithole
<b>2011</b>

Liza-Mari (L-M) Coetzee
Helgard (H) Cronjé
Hügo (H) Krüger
Leonaye (L) Massyn
Raymond (R) Ntlozi
Duncan (D) Platt
Tebogo (T) Twala (2011–2012)
Nadine (N) Van der Haar
Mark (M) Vorster
<b>2012</b>
Tsatsawani (T) Chauke
Pierre (P) Cloete
Simone (S) Engelbrecht
Jordan Griffiths
Tiaan (T) Koen
Kleinbooi (K) Legoabe
Thobekani (TE) Malatula
Mthokozisi (M) Nkosi
Camille (C) Pienaar
<b>2013</b>
Nanika (N) Coetzee
Luyolo (L) Dulaze
Enwee (E) Human
Mmathapelo (M) Lethutso
Sina (S) Malabana
Wanga (W) Mbasa
Khutso (K) Mogotsi
Nomsa (N) Nhlangulela
Wayne (W) Renkin
Wayne (W) Renkin
Grace (G) Soko
<b>2014</b>
Marna (M) De Jager
Monique (M) Du Randt
Kiandiko (K) Kasure
Belinda (B) Kelly
Marco (M) Koch
Gabriel (G) Nel
Kim (K) Ngobeni
Nthabiseng (N) Nooe
Lohann (L) Pretorius
Wilbri (W) Vorster

<b>2015</b>
Liezel (L) Aylward
Adrian (A) Eckard
Reitumetse (R) Ratlhogo
Henrico (H) Barnard
David (D) Sawyerr
Karabo (K) Sekhukhuni
Jhua-Nine (J-N) Wirley-Birch
Sibahle (S) Sgwane
Gerhardus (G) Pretorius
Clarindi (C) Greeff
<b>2016</b>
A van Vuuren (2016–2017)
Benjamin (B) Ho
Darragh (D) Meaker
Donovan (D) du Plooy
Kabelo (K) Motlhakane
Lethlabile (L) Makone
Maram (M) Mahdi
Michael Bongani (MB) Reinders
Pieter (P) Scribante
Thabo (T) Shingange
<b>2017</b>
Tinashe (T) Chingoka
Boyani (B) Mpasha
Cara-Lee (C-L) Compton
Roahan (R) Gouws
Nosihle (N) Msomi
Simba (S) Gwati
Dalrée De Lange
Maikeleng (M) Ledimo
<b>2018</b>
Janie (J) Geldenhuys
Phindile (P) Makhombothi
Lihle (L) Ngubane
Jodie (J) Chikowi
Heidi (H) Davis
Linda (L) Mtsweni
Soraia (S) Machado
Kutlwano (K) Mositi
Kwena (K) Moloto
Kyle (K) Goosen

## Appendix G | Student Representative Council

### 2009

**SRC of 16 members plus two office bearers of the Student Assembly.**

Portfolio	Incumbent
<b>SRC</b>	
Chairperson	Hector Beyers
Deputy Chairperson	Charl Oberholzer
Secretary-General	Tiyani Majoko
Treasurer, International Student Relations and Onderstepoort	Frans van Heerden
Academics	Enke-Mari Malherbe
Community Development	Rozaan Steenkamp
Day and Faculty Houses and Prinshof Campus	SW Burger
Internal Projects, Sponsors and Groenkloof Campus	Monica van Tonder
Justice and Constitutions	Nerene Were
Marketing and External Projects	Annézel Otto
Residences	Elsje Blignaut
Safety, Security and Facilities	Coert Erasmus
Service Providers	Fouché Deetlefs
Societies	Lebogang Motswanyane
Student Affairs, PRO and Mamelodi	Zwelakhe Makuhleni
<b>Student Assembly</b>	
Speaker	Marius Ellis
Deputy Speaker	Miki Vermeulen

### 2010

**Temporary Student Committee of 13 members.**

Portfolio	Incumbent
Chairperson	Marius Ellis
Deputy Chairperson, Service Providers and Community Development	Tiyani Majoko
Secretary-General	Natasha Gresse
Treasurer	Dineo Siko
Academics	Mario Fasondini
Day and Faculty Houses	Awie Erasmus
Internal Projects, Sponsors and External Campuses	Armand Goutondji
Justice and Constitutions	Tiyani Sithole
Marketing and Projects	Megan Howard
Residences	Hanri Niemand

Safety, Security and Facilities	Michael Shackleton
Societies	Nyasha Kuzinya
Student Affairs	Zwelakhe Makuhleni

### 2011

**SRC comprising 20 members.**

Portfolio	Incumbent
President	Charl Oberholzer
Vice-President and Internal and External Enterprises	Helgard Cronjé
Secretary-General	Katlego Malatji
Treasurer-General	Lisa-Mari Coetzee
Academic Affairs and Honorary Colours	Raymond Ntlozi
Community Development	Kelebogile Mokgabudi
Day and Faculty Houses	Quintin Botha
External Campuses	Gillian Siwela
International Student Relations	Kendi Mwabila
Justice and Constitutions	Michael Matlapeng
Multilingualism and Culture	Hugo Krüger
PRO and Sponsorships	Charles Britz
Projects	Johannes Muller
Residences	Anzel Steyn
Safety, Security and Facilities	Mark Vorster
Service Providers and Technology	Duncan Platt
Societies	Anné Thiart
Study Finance and Transport	Mthokozisi Nkosi
Student Well-being	Tjaart de Lange
Tukkie Pride	Leonaye Massyn

### 2012

**Temporary Student Committee consisting of 11 members, appointed from January 2012.**

Portfolio	Incumbent
Chairperson	Mthokozisi Nkosi
Deputy Chairperson	Anél Swart
Secretary-General, Communication and Website	Kleinbooï Legoabe
Treasurer-General	Tebogo Twala
Academic Affairs and Honorary Colours	Carlo Cock
Constitutions	Charles Britz

External Campuses and Faculty Houses	Thinus Dicks
Facilities and Service Providers	Henning Viljoen
Residences	Janie Bosman Danie Ungerer
Societies	Jessica Mgidi

### 2012

**SRC of 21 members and two office bearers of Student Assembly.**

Portfolio	Incumbent
President	Mthokozisi Nkosi
Deputy President and Service Providers	Gerbrand Lindeque
Secretary-General	Kleinbooï Legoabe
Treasurer-General	Tebogo Twala
Academic Affairs and Honorary Colours	Chris Pappas
Community Engagement	Angel Bolosha
Culture and Language	Thobekani Malatula
Day and Faculty Houses	Thinus Dicks
External Campuses	Claudette Veldhuizen
International Students	Simba Tavuyanago
Justice and Constitutions and Transport	Jordan Griffiths
Projects	Tiaan Koen Camille Pienaar
Residences	Simone Engelbrecht Nic Stead
Safety, Security and Facilities	Pierre Cloete
Societies	Tsatsawani Chauke
Study Finance	Mpume Mbongo
Student Wellbeing	Busisiwe Radebe
Technology Development and Sponsorships	Jozua Loots
Tukkie Pride (Marketing)	Atlegang Mogale
Student Assembly	
Speaker	Enwee Human
Deputy Speaker	Darren Neethling

### 2013

**Temporary Student Committee with 12 members.**

Portfolio	Incumbent
President	Chris Pappas
Deputy President and Projects	Jordan Griffiths
Secretary-General	Luyolo Dulaze
Treasurer-General	Simóne Engelbrecht
Academics	Mmathapelo Lehutso
Constitution and Policies	Enwee Human

Day and Faculty Houses	Sina Malabana
Facilities and Transport	Wayne REnkin
International Students	Grace Soko
PRO and Technology Development	Wanga Mbsa
Residences	Nanika Coetzee
Societies	Khutso Mogotsi

### 2014

**Full 19-member SRC consisting of 12 elective and 7 ex officio portfolios.**

Portfolio	Incumbent
<b>SRC Executive (5)</b>	
President	Enwee Human
Deputy President	Taymoon Mohammed-Altamash
Secretary	Monique du Randt
Deputy Secretary	James Lotter
Treasurer	Arno Burger
Ex officio members (7)	
Academics	Marco Koch Johanna Nashitati
Residences	Belinda Kelly Gabriel Nel
Student Culture	Lohann Pretorius
Student Sport	Xabiso Sicwebu
Tuks RAG	Kiandiko Kasure
<b>Elective portfolios (7)</b>	
Day Students and External Campuses	Marna de Jager
Facilities, Safety and Security	Kim Ngobeni
Marketing, Media and Communications	Khutso Ntuli
Postgraduate and International Students	Wilbri Vorster
Societies	Matshepo Tladi
Study Finance	Amy Ashworth
Transformation and Student Success	Nthabiseng Nooe

### 2015

**Full 19-member SRC consisting of 12 elective portfolios and 7 ex officio portfolios.**

Portfolio	Incumbent
<b>SRC Executive (5)</b>	
President	Mosibudi Rasethaba
Deputy President	Luvuyo Menziwa
Secretary	Adrian Eckard
Deputy Secretary	Liezl Aylward

Treasurer	Marna de Jager
<b>Ex officio members (7)</b>	
Academics	David Swayerr Karabo Sekhukhuni
Residences	Clarindi Greeff Jarik Jansen
Student Culture	Thandeka Mogoerane
Student Sport	Nashmirha Bhamjee
Tuks RAG	Bettina Bertolini
<b>Elective portfolios (7)</b>	
Day Students and External Campuses	Reithumetse Rathlogo
Facilities, Safety and Security	Sibahle Sgwane
Marketing, Media and Communication	Tumelo Rasebopye
Postgraduate and International Students	Henrico Barnard
Societies	Michelle Krüger
Study Finance	Gerhardus Pretorius
Transformation and Student Success	Jhua-Nine Wyrley-Birch

**2016**  
SRC of 17, comprising 10 elective and 7 ex-officio portfolios.

Portfolio	Incumbent
<b>SRC Executive (5)</b>	
President	Vacant
Deputy President	Vacant
Secretary	Donovan du Plooy
Deputy Secretary	Thabo Shingange
Treasurer	Nomtha Gobe
<b>Ex officio members (7)</b>	
Academics	Darragh Meaker Kabelo Motlhakane
Residences	Michael Bogani Reinders Ansa van Vuuren
Student Culture	Pieter Scribante
Student Sport	Maram Mahdi
Tuks RAG	Peter Kamlongera
<b>Elective portfolios (7)</b>	
Day Students and External Campuses	Anleo Jansen
Facilities, Safety and Security	Brian Nkala
Marketing, Media and Communication	Nobungwele Mbem
Postgraduate and International Students	Benjamin Ho
Societies	Lethlabile Makone
Study Finance	Luvuyo Menziwa
Transformation and Student Success	Mizanne van Niekerk

**2017**  
Ten-member Temporary Student Committee.

Portfolio	Incumbent
Chairperson	Henrico Barnard
Deputy Chairperson and Study Finances	Thabo Shingange
Secretary and Marketing	Cara-Lee Compton
Deputy Secretary and Sport	Boyani Mphasha
Treasurer	Ansa van Vuuren
Academics	Nosihle Msomi
Residences	Dalrée de Lange
Day Students and Residences	Tinasha Chingoka
Facilities and RAG	Roahan Gouws
Postgraduate Students and Academics	Simba Gwati
<b>Societies</b>	
	Cameron Rajoo
Transformation	Maikeleng Ledimo

**2018**  
Full 19-member SRC consisting of 12 elective portfolios and 7 ex-officio portfolios.

Portfolio	Incumbent
<b>SRC Executive (5)</b>	
President	Kwena Moloto
Deputy President	Mamello Molotsi
Secretary	Soraia Machado
Deputy Secretary	Kutlwano Mositi
Treasurer	Duane-Jeffrey van Wyk
<b>Ex officio members (7)</b>	
Academics	Janie Geldenhuys Romario Roman
Residences	Heidi Davis Aaron Masemola
Student Culture	Mone Erasmus
Student Sport	Therese Roddink
Tuks RAG	Phindile Makhomboti
<b>Elective portfolios (7)</b>	
Day Students and External Campuses	Stanford Ndlovu
Facilities, Safety and Security	Lindi Mtsweni
Marketing, Media and Communication	Kyle Goosen
Postgraduate and International Students	Jodie Chikowi
Societies	Obakeng Sepeng
Study Finance	Akhona Mdunge
Transformation and Student Success	Lihle Ngubane

## Appendix H | UP Academic Achievers' Awards

Chancellor's Award   Research		
<b>2011</b>		
Bennett, N	Zoology and Entomology	NAS
Hassan, R	Centre for Environmental Economics and Policy in Africa	NAS
<b>2012</b>		
Wingfield, B	Genetics, Forestry and Agricultural Biotechnology Institute	NAS
<b>2013</b>		
Nicolson, S	Zoology and Entomology	NAS
<b>2015</b>		
Cowan, D	Genetics, Genomics Research Institute	NAS
<b>2016</b>		
Slippers, B	Genetics, Forestry and Agricultural Biotechnology Institute	NAS
<b>2018</b>		
Bennett, N	Zoology and Entomology	NAS
Chancellor's Award   Teaching and Learning		
<b>2010</b>		
Maree, K	Educational Psychology	Education
<b>2017</b>		
Hanekom, T	Electrical, Electronic and Computer Engineering	EBIT
Vice-Chancellor's Book Award		
<b>2015</b>		
Boeyens, J	Physics	NAS
Fioramonti, L	Political Sciences	Humanities
<b>2016</b>		
Sandwith, C	English	Humanities
<b>2017</b>		
Van Onselen, C	Historical and Heritage Studies	Humanities
<b>2018</b>		
Brits, R	Mercantile Law	UP Law
Vice-Chancellor's Exceptional Supervisor Award		
<b>2016</b>		
Meyer, J	Mechanical and Aeronautical Engineering	EBIT
<b>2017</b>		
Bennett, N	Zoology and Entomology	NAS
<b>2018</b>		
Birkholtz, L-M	Biochemistry	NAS

Exceptional Academic Achiever Award		
<b>2009</b>		
Ayo-Yusuf, L	Community Dentistry	Health Sciences
Bishop, J	Computer Science	EBIT
Boezaart, T	Private Law	UP Law
Cameron, E	Zoology and Entomology	NAS
Cloete, E	Microbiology and Plant Pathology	NAS
Eloff, J	Computer Science	EBIT
McKechnie, A	Zoology and Entomology	NAS
Meyer, M	Plant Sciences	NAS
Naidoo, V	Paraclinical Sciences	Veterinary Science
Nicolson, S	Zoology and Entomology	NAS
Ozoemena, K	Chemistry	NAS
Penzohorn, B	Veterinary Tropical Diseases	Veterinary Science
Prinsloo, D	African Languages	Humanities
Rohwer, E	Chemistry	NAS
Slippers, B	Genetics	NAS
Ströh, A	Dean	NAS
Taylor, J	Food Science	NAS
Van Aarde, R	Zoology and Entomology	NAS
Van Heerden, W	Oral Pathology and Oral Biology	Health Sciences
Van Wyk, B	Plant Science	NAS
Venter, M	Medical Virology	Health Sciences
<b>2010</b>		
Auret, D	Physics	NAS
Bennett, N	Zoology and Entomology	NAS
Birkholtz, L	Biochemistry	NAS
Bothma, T	Information Science	EBIT
Boy, S	Oral Pathology and Oral Biology	Health Sciences
Du Toit, M	Materials Science and Metallurgical Engineering	EBIT
Engelbrecht, A	Computer Science	EBIT
Ferreira, R	Educational Psychology	Education
Hofmeyr, B	Philosophy	Humanities
Kirsten, J	Agricultural Economics, Extension and Rural Development	NAS
Lubuma, J	Mathematics and Applied Mathematics	NAS
Malherbe, J	Physics	NAS

Meyer, J	Mechanical and Aeronautical Engineering	EBIT
Nel, L	Biochemistry, Genetics and Microbiology	NAS
Steyn, M	Anatomy	Health Sciences
Swanepoel, DW	Speech-Language Pathology and Audiology	Humanities
Van Marle, K	Jurisprudence	UP Law
Viljoen, F	Centre for Human Rights	UP Law
Wingfield, B	Genomics Research Institute	NAS
Xia, X	Electrical, Electronic and Computer Engineering	EBIT
<b>2011</b>		
Bester, M	Zoology and Entomology	NAS
Boraine, A	Mercantile Law	UP Law
Cukrowski, I	Chemistry	NAS
Franzsen, R	Economics, African Tax Institute	EMS
Greeff, J	Genetics	NAS
Heyns, C	Centre for Human Rights	UP Law
Joubert, J	Electrical, Electronic and Computer Engineering	EBIT
Korsten, L	Microbiology and Plant Pathology	NAS
Lotz, S	Chemistry	NAS
Odendaal, W	Electrical, Electronic and Computer Engineering	EBIT
<b>2012</b>		
Altermann, W	Geology	NAS
Eriksson, P	Geology	NAS
Meyer, M	Plant and Soil Sciences	NAS
Nicolson, S	Zoology and Entomology	NAS
Prinsloo, D	African Languages	Humanities
Rakitianski, S	Physics	NAS
Rohwer, E	Chemistry	NAS
Scholtz, C	Zoology and Entomology	NAS
Steyn, G	New Testament Studies	Theology
Ströh, A		NAS
van Wyk, B	Plant Science	NAS
<b>2013</b>		
Auret, D	Physics	NAS
Bennett, N	Zoology and Entomology	NAS
Bothma, T	Information Science	EBIT
Coutinho, T	Microbiology and Plant Pathology	NAS
Craig, I	Electrical, Electronic and Computer Engineering	EBIT
Du Toit, M	Materials Science and Metallurgical Engineering	EBIT

Engelbrecht, A	Computer Science	EBIT
Kirsten, J	Agricultural Economics, Extension and Rural Development	NAS
Lubuma, J	Mathematics and Applied Mathematics	NAS
McKechnie, A	Zoology and Entomology	NAS
Meyer, J	Mechanical and Aeronautical Engineering	EBIT
Millar, R	Centre for Neuroendocrinology	Health Sciences
Myburg, Z	Genetics	NAS
Nel, L	Biochemistry, Genetics and Microbiology	NAS
Pattinson, R	Centre for Maternal, Fetal, Newborn and Child Health Care Strategies	Health Sciences
Steyn, M	Anatomy	Health Sciences
Taylor, J	Food Science	NAS
Van Marle, K	Jurisprudence	UP Law
Van Onselen, C	Historical and Heritage Studies	Humanities
Viljoen, F	Centre for Human Rights	UP Law
Wingfield, M	Forestry and Agricultural Biotechnology Institute	NAS
Xia, X	Electrical, Electronic and Computer Engineering	EBIT
<b>2014</b>		
Anguelov, R	Mathematics and Applied Mathematics	NAS
Bester, M	Zoology and Entomology	NAS
Boraine, A	Mercantile Law	UP Law
Bornman, R	Urology	Health Sciences
De Wet, E	Institute for International and Comparative Law in Africa	UP Law
Greeff, J	Genetics	NAS
Joubert, J	Electrical, Electronic and Computer Engineering	EBIT
Korsten, L	Microbiology and Plant Pathology	NAS
Maree, K	Educational Psychology	Education
Myburg, Z	Genetics	NAS
Odendaal, W	Electrical, Electronic and Computer Engineering	EBIT
Roux, J	Microbiology and Plant Pathology	NAS
<b>2015</b>		
Altermann, W	Geology	NAS
Focke, W	Chemical Engineering	EBIT
Hassan, R	Centre for Environmental Economics and Policy in Africa	NAS

Meyer, M	Plant Science	NAS
Pepper, M	Immunology	Health Sciences
Scholtz, C	Zoology and Entomology	NAS
<b>2016</b>		
Coutinho, T	Microbiology	NAS
Ebersohn, L	Educational Psychology	Education
Kirsten, J	Agricultural Economics, Extension and Rural Development	NAS
Lubuma, J	Mathematics and Applied Mathematics	NAS
McKechnie, A	Zoology and Entomology	NAS
Nel, L	Microbiology and Plant Pathology	NAS
Taylor, J	Food Science	NAS
Viljoen, F	Centre for Human Rights	UP Law
<b>2017</b>		
Anguelov, R	Mathematics and Applied Mathematics	NAS
Craig, I	Electrical, Electronic and Computer Engineering	EBIT
Greeff, J	Genetics	NAS
Meyer, J	Mechanical and Aeronautical Engineering	EBIT
Myburg, Z	Genetics	NAS
Pattinson, R	Obstetrics and Gynaecology	Health Sciences
Roux, J	Plant and Soil Sciences	NAS
Schoeman, J	Companion Animal Clinical Studies	Veterinary Science
Venter, F	Microbiology and Plant Pathology	NAS
Zimper, A	Economics	EMS
<b>2018</b>		
Bornman, J	Centre for Augmentative and Alternative Communication	Humanities
Botha, C	Paraclinical Studies	Veterinary Science
Heyns, C	Centre for Human Rights	UP Law
Skelton, A	Private Law	UP Law
<b>Exceptional Young Researcher Award</b>		
<b>2009</b>		
Ayo-Yusuf, L	Dental Management Sciences	Health Sciences
Naidoo, V	Paraclinical Sciences	Veterinary Science
Venter, M	Medical Virology	Health Sciences

<b>2010</b>		
Birkholtz, L-M	Biochemistry	NAS
Boy, SC	School of Medicine	Health Sciences
Ferreira, R	Educational Psychology	Education
Hofmeyer, B	Philosophy	Humanities
<b>2011</b>		
L'Abbe, E	Anatomy	Health Sciences
Steenkamp, E	Biochemistry, Genetics and Microbiology	NAS
<b>2012</b>		
Dzikiti, B	Companion Animal Clinical Studies	Veterinary Science
Myburg, Z	Genetics	NAS
Pirk, C	Zoology and Entomology	NAS
Rouget, M	Plant Science	NAS
<b>2013</b>		
Birkholtz, L	Biochemistry	NAS
Fasina, FO	Production Animal Studies	Veterinary Science
Fioramonti, L	Political Sciences	Humanities
Maritz-Olivier, C	Genetics	NAS
Oosthuizen, M	Zoology and Entomology	NAS
Slippers, B	Genetics	NAS
<b>2014</b>		
Abolnik, C	Production Animal Studies	Veterinary Science
Inglesi-Lotz, R	Economics	EMS
Markotter, W	Microbiology and Plant Pathology	NAS
Meyer, F	Agricultural Economics, Extension and Rural Development	NAS
Venter, E	Taxation	EMS
Weldon, C	Zoology and Entomology	NAS
<b>2015</b>		
Barnes, I	Genetics	NAS
Emmambux, N	Food Science	NAS
<b>2016</b>		
De Bruyn, N	Zoology and Entomology	NAS
Le Roux, P	Plant Science	NAS
<b>2017</b>		
Coetzee, S	Accounting	EMS
Coetzee, V	Genetics	NAS
Crole, M	Anatomy and Physiology	Veterinary Science
Hurley, B	Zoology and Entomology	NAS

Malekian, R	Electrical, Electronic and Computer Engineering	EBIT
Phulukdaree, A	Physiology	Health Sciences
<b>2018</b>		
Helbig, M	Computer Science	EBIT
Kruger, T	Physics	NAS
Mayaphi, S	Medical Virology	Health Sciences
Mizrachi, E	Biochemistry, Genetics and Microbiology	NAS
<b>Teaching Excellence and Innovation Award</b>		
<b>2014</b>		
Pilcher, L	Chemistry	NAS
Mathabathe, K	Science, Mathematics and Technology Education	Education
Van Oordt, T	Taxation	EMS
Riley, D	Chemistry	NAS
<b>2015</b>		
Hanekom, T	Electrical, Electronic and Computer Engineering	EBIT
Corbett, T and Kraamwinkel, C (team)	BSc Extended Degree	NAS and Mamelodi Campus
<b>2016</b>		
Forbes, P	Chemistry	NAS
Coetzee, S and Schmulian (team)	Accounting	EMS

<b>2017</b>		
Wolff, E	Philosophy	Humanities
Joynt, C and Cloete, M	Accounting	EMS
<b>2018</b>		
Crole, M	Anatomy and Physiology	Veterinary Science
Vandeyar, T	Science, Mathematics and Technology Education	Education
<b>Community Engagement</b>		
<b>2015</b>		
Jordaan, M	Community Based Research & Postgraduate Studies	Mamelodi Campus
<b>2016</b>		
Fritz, C and Grobler, F	Law Clinic	UP Law
<b>2017</b>		
Van Dijk, M	Civil Engineering	EBIT
<b>2018</b>		
Rautenbach, V	Information Technology	EBIT

## Appendix I | Student Residences

Summary of residence name changes, gender and capacity, as in 2018

<b>HATFIELD</b>				
	<b>Residence</b>	<b>Previous name</b>	<b>Gender</b>	<b>Capacity</b>
1.	House Nala	Klaradyn	Female	270
2.	House Khutso	Jasmyn	Female	295
3.	Erica	Erika	Female	325
4.	Asterhof		Female	323
5.	Madelief		Female	310
6.	Nerina		Female	297
7.	House Mags	Magrietjie	Female	332
8.	Xayata		Both	92
<b>HILLCREST</b>				
9.	Azalea	Katjeepering	Female	234
10.	College	Kollege	Male	247
11.	The Tower	Taaibos	Male	237
12.	Tuks Ekhaya	Olienhout	Male	289
13.	House TAU	Boekenhout	Male	295
14.	Mopane	Mopanie	Male	223
15.	Morula Legae	Maroela	Male	224
16.	TuksVillage		Both	640

<b>GROENKLOOF</b>				
	<b>Residence</b>	<b>Previous name</b>	<b>Gender</b>	<b>Capacity</b>
17.	Zinnia		Female	326
18.	Tirisano	Kiaat	Male	326
19.	Hayani	Lilium	Female	326
20.	Ikageng	Inca	Female	326
<b>MAMELODI</b>				
21.	Khanyisa Naledi	Tuks Naledi	Both	162
<b>ONDERSTEPOORT</b>				
22.	OP Village	Onderstepoort Residence	Both	660
<b>PRINSHOF</b>				
	<b>Residence</b>	<b>Previous name</b>	<b>Gender</b>	<b>Capacity</b>
23.	Hippokrates		Both	167
24.	Tuks Bophelong		Both	296
25.	House Ukuthula	Olympus	Male	192
26.	Curelitzia	Curlitzia	Female	363
<b>POSTGRADUATE</b>				
27.	Jakaranda		Both	143
28.	Tuksdorp		Both	222
29.	Protea Mbalenhle	Protea	Both	65

# Appendix J | Information Design Student Competition

The BA Information Design degree at UP is one of the most highly regarded communication design degrees in Africa and the Middle East, having won multiple awards. With the production of *Ad Destinatum VI* it was a perfect opportunity to involve these gifted students in its design and layout. Under the guidance of Prof Duncan Reyburn and the project leader Amy van Vuuren, third-year Information Design students were tasked with coming up with a visual expression for *Ad Destinatum VI* that would result in a well-considered, holistic designed product. There was much room for exploration,

and the aim was to generate something appealing and surprising, but still appropriate to the image of the University. The students set hard to work, and the results spoke for themselves. In the end, the editorial committee agreed that special mention should be made of a number of creative solutions provided by the students. Ten students received certificates of merit, in recognition of their work. Their cover designs are reproduced here. The winning design was awarded to Marcholette Minnaar.



Khemira Soobramoney

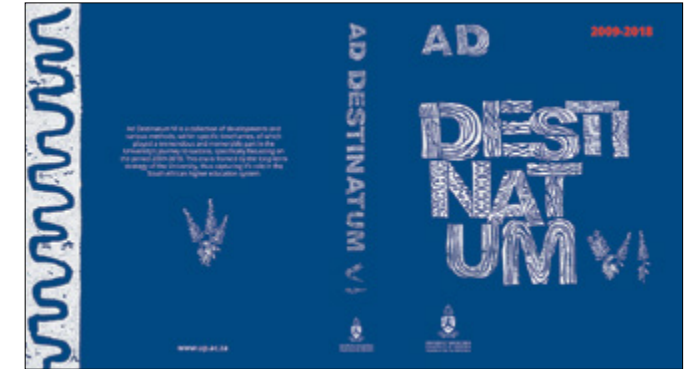

Leàn van den Berg

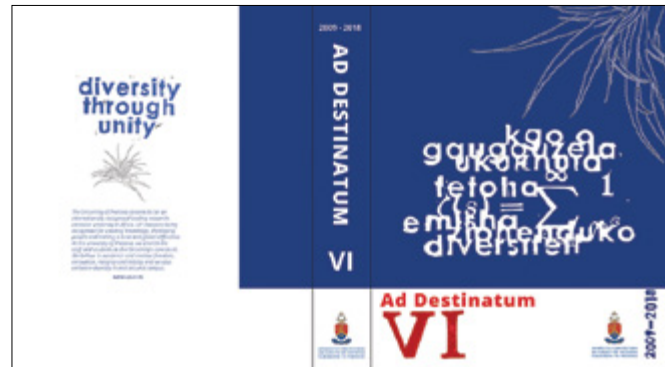

Amber Oberholzer

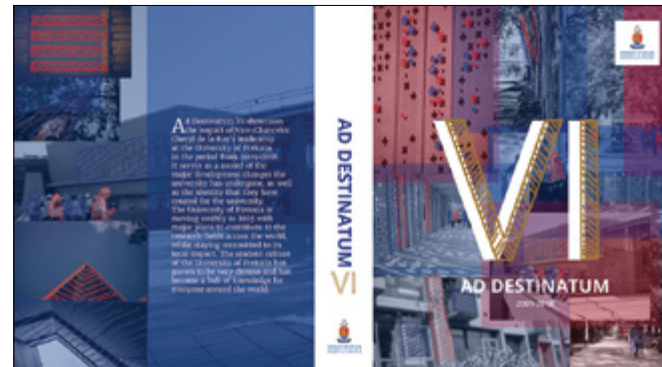

Berno van der Westhuizen

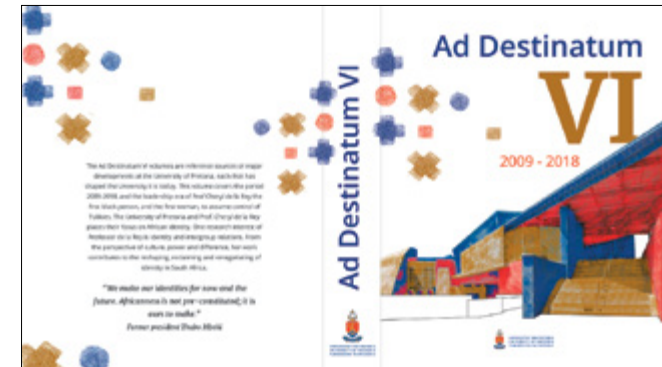

Leané Greeff

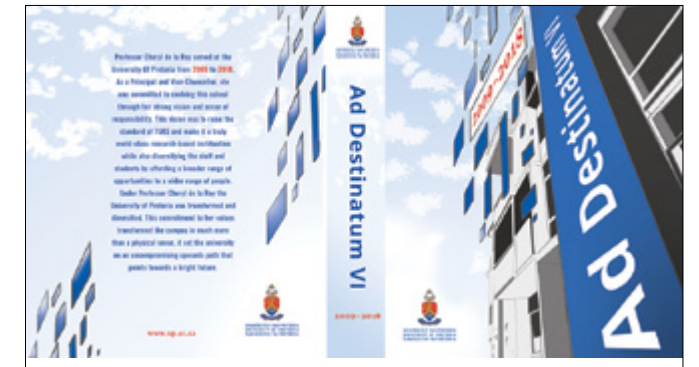

Orateng Nkwe

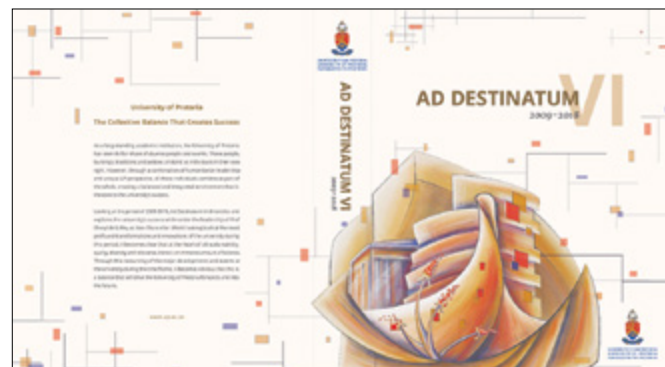

Bronwyn Sinclair

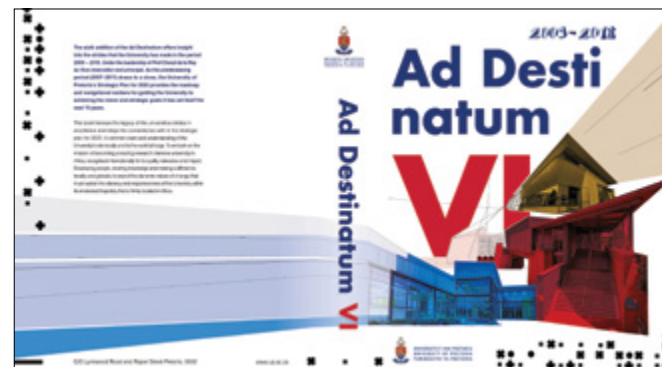

James Dufana



Rachel van Zyl



Theresa Matthews

## A celebration

During the evening of 18 August 2022, a small event was held at the UP School of the Arts to thank and congratulate the students on their efforts. The photos on this page show the designer, Sanet du Plessis and Marcholette Minnaar; Prof Duncan Reyburn, with the students who received merit awards for their designs; and finally, a group photo of the students with some of the guests present at the event.

The celebration was attended by the students and a number of colleagues, including members of the *Ad Destinatum VI* editorial committee; the Humanities Deputy Dean of Teaching and Learning, Prof Innocent Pikirayi; the Head of the School of the Arts, Prof Alexander Johnson; the Chair of Visual Arts, Prof Lize Kriel; and Prof Tawana Kupe, the new Vice-Chancellor and Principal of the University of Pretoria.



## Abbreviations and Acronyms

### A

4IR	Fourth Industrial Revolution
AA	Academic Administration
AAAS	American Association for the Advancement of Science
AAC	Augmentative and alternative communication
AACSB	Advance Collegiate Schools of Business
AACSB	Association to Advance Collegiate Schools of Business
AAR	American Academy of Religion
AAS	African Academy of Science
AAUN	Australia-Africa University Network
ABDC	Australian Business Deans Council
ABLU	Annual Banking Law Conference
ACALAN	Academy for African Languages
ACAP	American Cleft Lip Palate Association
ACE	Advanced Certificate in Education
ACEIE	African Centre of Excellence in Information Ethics
ACF	Arts Centre Foundation
ACFE	Association of Certified Fraud Examiners
ACGT	African Centre for Gene Technologies
ACoE	Africa Centers of Excellence
ACPA	African Consortium of Public Administration
ACSG	Annual South African Assessment Centre Study Group
ACSM	American College of Sport Medicine
ACT	American College of Theriogenology
AERC	African Economic Research Consortium
AFAM	African Academy of Management
AFCP	Ambassadors Fund for Cultural Preservation
AFMA	Animal Feed Manufacturers Association
Afrilex	African Association for Lexicography
AfriVIP	African Veterinary Information Portal
AfSM	African Soil Microbiomics project
AfSUG	SAP African User Group
AGP	Antibiotic growth promotants
AHS	African horse sickness
AI	Artificial insemination
AIDS	Acquired immunodeficiency syndrome
AIDS	Artificial intelligence
AIM	Academy of Management Journal
AIMS	African Institute for Mathematical Science
AJPA	African Journal of Public Affairs
ALCRL	Albert Luthuli Centre for Responsible Leadership
ALDP	Agricultural Leadership Development Programme
AMBA	Association of MBAs
AMLA	African Mining Legislation Atlas Project
AMS	Abbott auto management system
ANIE	African Network for Internationalisation of Education
ANU	Australian National University
APC	Academic Planning Committee
APQ	Academic Planning and Quality
APS	Admission point scores
APSA	Academic and Professional Staff Association of the Universities of South Africa
APT	Accelerated Pavement Testing

### AQA

AR	Augmented reality
ARC	Agricultural Research Council
AROS	Akademie Reformatoreise Opleiding en Studies
ARUA	African Research Universities Alliance
ARWU	Academy Ranking of World Universities
ASAQS	Association of South African Quantity Surveyors
ASASWEI	South African Social Work Education Institutions
ASEAN	Association of Southeast Asian Nations
ASELPH	Albertina Sisulu Executive Leadership Programme in Health
ASIS&T	iSchool, Association of Information Science and Technology
ASLP	Africa Science Leadership Programme
ASN	Advanced Sensor Networks
ASOCSA	Associated Schools of Construction of Southern Africa
ASPs	After-school programmes
ASSA	Actuarial Society of South Africa
ASSA	Anatomical Society of South Africa
ASSAf	Academy of Science of South Africa
ASSHH	Association for the Social Sciences and Humanities
ASSIG	Scholarly Interest Group for Anatomical Sciences
ATA	Agricultural Transformation in Africa
ATI	African Tax Institute
ATKV	Afrikaans Language and Culture Association,
AU	African Union
AVBC	Australasian Veterinary Boards Council
AZD	Animal and Zoonotic Diseases

### B

BE at UP	Business Enterprises at UP
BGM	Biochemistry, Genetics and Microbiology
BGP	Southern African Beef Genomics Programme
BIG	Business Innovations Group
BIRAP	Bureau for Institutional Research and Planning
BOP	Base of the Pyramid
BRICS	Brazil, Russia, India, China and South Africa
BRS	Biblical and Religious Studies
BUSA	Business Unity South Africa
BVF	Black Veterinary Forum
BWMC	Broadband Wireless Multimedia Communication

### C

CA	Chartered accountancy
CAAC	Centre for Augmentative and Alternative Communication
CACIL	Centre for Advanced Corporate and Insolvency Law
CAIR	Centre for AI Research
CALS	Centre for Applied Legal Studies
CAMM	Centre for African Management and Markets
CANSA	Cancer Association of South Africa
CAS	Centre for the Advancement of Scholarship
CBCB	Centre for Bioinformatics and Computational Biology
CBS	Centraal Bureau voor Schimmelcultures
CCGT	Kudu Combined Cycle Gas Turbine
CCL	Centre for Child Law
CCM	Centre for Contextual Ministry

CCNY	Carnegie Corporation of New York	CSC	Client Services Centre	ECCE	Early Childhood Care and Education	<b>G</b>	
CCS	Carbon capture and storage	CSI	Corporate Social Investment	ECE	Department of Early Childhood Education	GANAA	Department hosted the German-African Network of Alumni and Alumnae
CDC	Centers for Disease Control and Prevention	CSI	(South African) Committee for Spatial Information	ECOG	Eastern Cooperative Oncology Group	GAP	Gauteng Accelerator Programme
CE	Community engagement	CSIR	Council for Scientific and Industrial Research	ECRLF	Early Career Research Leadership Fellowship	GCASE	Global Community of Anatomical Science Educators
CE at UP	Continuing Education at UP Trust	CSR	Centre for the Study of Resilience	ECISA	Engineering Council of South Africa	GDPR	General Data Protection Regulation
CEA	Centre for Evaluation and Assessment	CT	Computerised tomography	EDC	Endocrine Disrupting Chemical	GERMS	Group for Enteric, Respiratory and Meningeal disease. Surveillance in South Africa
CEEMAN	Central and East European Management Development Association	CTBS	Cape Town Baptist Seminary	EDHE	Entrepreneurship Development in Higher Education	GGM	Geography, Geoinformatics and Meteorology
CEEPA	Centre for Environmental Economics and Policy in Africa	CTHB	Centre of Excellence in Tree Health Biotechnology	EDPs	Extended degree programmes	GIBS	Gordon Institute of Business Science
CEFIM	Carl and Emily Fuchs Institute for Microelectronics	CUT	Central University of Technology	EE	Employment Equity	GIRNS	Global Influenza Response Networks Surveillance
CELP	Centre for Educational Law and Policy	CVD	Chemical vapor deposition	EEDSM	Energy efficiency and demand-side management	GLOSS	Global Maternal Sepsis Study
CEN	Committee for Electrotechnical Standardisation	CVIS	Centre for Visual Impairment Studies	EFMD	European Foundation for Management Development	GMASSURE	Assuring Agricultural and Food Safety of Genetically Modified Organisms in Southern Africa
CEPHS	Centre of Ethics and Philosophy of Health Sciences	CVN	Centre for Viral Zoonoses	EHI	Environmental Humanities Initiative	GovInn	Centre for the Study of Governance Innovation
CERG	Clean Energy Research Group	CVWS	Centre for Veterinary Wildlife Studies	EI	Education Innovation	GRaSP	Office of Government Relations and Special Projects
CERU	Conservation Ecology Research Unit	CWM	Centre for Wildlife Management	EKG	Electronic gatekeeping	GRI	Genomics Research Institute
CET	Community Education and Training	<b>D</b>		ELA	European Logistics Accreditation	GSH	Graduate Support Hub
CeTEIS	Centre for Teletraffic Engineering for the Information Society	DAAD	German Academic Exchange Service	ELRC	Exotic Leather Research Centre	GSP	Global Studies Programme
CFA	Chartered Financial Analyst	DBA	Doctor of Business Administration	EMEA	South Africa in the Europe, Middle-East and Africa	GSTM	Graduate School of Technology Management
CFES	Centre for Environmental Studies	DBE	Department of Basic Education	EMLP	Education Management Law and Policy		
CFO	Chief Financial Officer	DESA	Department of Enrolment and Student Administration	EMS	Faculty of Economic and Management Sciences		
CGIS	Centre for Geoinformation Science	DFID	British Department for International Development	ENSO	El Niño-Southern Oscillation		
CHE	Council on Higher Education	DGDC	Directorate-General for Development Cooperation	ENT	Ear, Nose and Throat		
CHET	Centre for Higher Education Transformation	DGP	Dairy Genomic Programme	EPFL	École polytechnique fédérale de Lausanne	<b>H</b>	
CHR	Centre for Human Rights	DHET	Department of Higher Education and Training	EPPEI	Eskom Power Plant Engineering Institute	HEDA	Higher Education Data Analyser
CID	Central Improvement District	DIA	Department of Institutional Advancement	ERC	Equine Research Centre	HEFCE	Higher Education Funding Council for England
CID	Hatfield City Improvement District	DIP	Department of Institutional Planning	ERC	European Research Commission	HEFMA	Higher Education Facilities Management Association
CIE	Computer Integrated Education	DIRCO	Department of International Relations and Cooperation	ERF	Economic Research Forum	HELM	Higher Education Leadership and Management
CILC	Centre for Insolvency, Labour and Corporate Law	DLS	Department of Library Services	ERSA	South African Reserve Bank and Economic Research Southern Africa	HELTASA	Higher Education Learning and Teaching Association of Southern Africa
CIMO	Centre for International Mobility	DMC	Directors' Management Committee	ERWAT	East Rand Water Care Company	HEMIS	South Africa Higher Education Management Information System
CIOB	Chartered Institute of Building	DoA	Department of Agriculture	ESASTAP	European—South African Science and Technology Advancement Programme	HEParD	Higher Education Parents Dialogue
CIPHER	Collaborative Initiative for Paediatric HIV Education and Research	DoE	Department of Education	ESEFA	Enterprise Systems Education for Africa	HEQF	Higher Education Qualifications Framework
CIRAD	International Centre for Research and Decision Support	DoE	Department of Energy	ESI	Emerging Scholars Initiative	HEQSF	Higher Education Qualifications Sub Framework
CJS	Centre for Japanese Studies	DoH	Department of Health	ESI	Essential Science Indicators	HERI	Higher Education Research and Innovation
CMA	Centre for Mediation in Africa	DOMH	Diploma in Occupational Medicine and Health	ESMOE	Essential Steps in Managing Obstetric Emergencies	HERS-SA	Higher Education Resource Services – South Africa
CMAAE	Collaborative MA in Applied Agricultural Economics	DPF	Directors' Planning Forum	ESSA	Economic Society of South Africa	HESA	Higher Education South Africa
CMEG	Centre for Microbial Ecology and Genomics	DPH	Diploma in Public Health	ESSA	Entomological Society of Southern Africa	HIV/AIDS	Human immunodeficiency virus
CMP	Conservation Management Plan	DRAA	Department of Residence Affairs and Accommodation	ESSAT	European Society for the Study of Science and Theology	HPC	High Performance Centre
CMR	Christian-Muslim Relations	DRC	Dutch Reformed Church	ETDP SETA	Education and Training Development Practices Sector Education and Training Authority	HPCSA	Health Professions Council of South Africa
CMSA	Colleges of Medicine of South Africa	DRI	Department of Research and Innovation	EU	European Union	HR	Department of Human Resources
CNE	Centre for Neuroendocrinology	DRIS	Department of Research and Innovation Support	EU-ACP	European Union-Africa, Caribbean and Pacific	HRM	Human Resource Management
CNES	Centre for New Energy Systems	DRS	Department of Religion Studies			HSRC	Human Sciences Research Council
CoBNeST	Conference of Biomedical and Natural Sciences and Therapeutics	DSA	Department of Student Affairs			HVAC	Heating, ventilation and air-conditioning
CoE	Centres of Excellence	DSI	Department of Science and Innovation			HWSETA	Health and Welfare Sector Education and Training Authority
CoE-FS	Centre of Excellence in Food Security	DSS	Department of Security Services	<b>F</b>			
CoP	Community of Practice	DST	Department of Science and Technology	FABI	Forestry and Agricultural Biotechnology Institute	<b>I</b>	
COPC	Community Oriented Primary Care	DTI	Department of Trade and Industry	FAK	Federasie van Afrikaanse Kultuurverenigings	IAEA	International Atomic Energy Agency
COSATU	Congress of South African Trade Unions	DUR	Department of University Relations	FARC	Forensic Anthropology Research Centre	IAEP	Internal Auditing Education Partnership
COSUP	Community-oriented substance use programme	DUT	Durban University of Technology	FIGO	International Federation of Gynaecology and Obstetrics	IAMS	International Association for Mission Studies
CoT	City of Tshwane	DVTD	Department of Veterinary Tropical Diseases	FMG	Forest Molecular Genetics	IAPL	International Association of Procedural Law
CPD	continuing professional development	<b>E</b>		FPD	Foundation for Professional Development	IASWG	Association of Social Work with Groups
CPHB	Centre of Excellence in Plant Health Biotechnology	EAC	East African Community	FRTs	Faculty Research Themes	ICASA	Independent Communications Authority of South Africa
CPT	Centre for Public Theology	EAP	Employee Assistance Programme	FSA	Faculty Student Advisors	ICFR	Institute for Commercial Forestry Research
CRIMSA	Criminological Society of Africa	EARB	Enterprise Architecture Review Board	FTE	Full-time equivalent	ICLA	Institute for International and Comparative Law in Africa
CSA&G	Centre for Sexualities, AIDS and Gender	EASA	Education Association of South Africa	FWCI	Field-weighted citation impact	ICMM	Institute for Cellular and Molecular Medicine
CSAEMP	Canada South Africa Education Management Project	EBIT	Engineering, Built Environment and Information Technology				
		ECAR	European College of Animal Reproduction				



ICRC	International Committee of the Red Cross	ISPA	Institute for Strategic and Political Affairs	MRIWU	Research Manager of the Whale Unit	OIE	World Organisation for Animal Health
ICSI	Intracytoplasmic sperm injection	ISPP	Secretary-General of the International Society of Plant Pathology	MRTEQ	Minimum Requirements for Teacher Education Qualifications	OPVSC	Onderstepoort Veterinary and Paraveterinary Student Committee
ICSU	International Social Science Council	ISPRS	International Society on Photogrammetry and Remote Sensing	MRU	Market Research Unit	OSGeo	Open Source Geospatial Foundation
ICT	Information and communication technology	ISSC	International Social Science Council	MTB	Mycobacterium tuberculosis	OSS	Optimise Student Services
ICTD	International Centre for Tax and Development	ISSTD	International Society for the Study of Trauma and Dissociation	MTIM	Technology and Innovation Management	OTAU	Onderstepoort Teaching Animal Unit
IDLU	International Development Law Unit	ITC	Initial Test of Competence	<b>N</b>		OTL	Department of Old Testament and Hebrew Scriptures
IEA	Evaluation of Educational Achievement	ITD	Innovation and Technology Division	NAS	Natural and Agricultural Sciences	OVAH	Onderstepoort Veterinary Academic Hospital
IEEE	Institute of Electrical and Electronics Engineers	ITI	International Team for Implantology	NCCEMD	National Committee for Confidential Enquiry in Maternal Deaths	OVC	Orphans and vulnerable children
IEG	Infrastructure and Efficiency Grant	ITM	Institute for Tropical Medicine	NCHE	National Commission on Higher Education	<b>P</b>	
IF	Institutional Forum	ITS	Information Technology Services	NCRST	Namibian National Commission for Research, Science and Technology	PAC	Production Animal Clinic
IFAD	International Fund for Agricultural Development	IUFRO	International Union of Forestry Research Organizations	NDP	National Development Plan	PBMR	Pebble bed modular reactor
IFCC	International Federation of Clinical Chemistry and Laboratory Medicine	IVF	In vitro fertilisation	NDRC	Netherdutch Reformed Church	PDBA	Postgraduate Diploma in Business Administration
IFLA	Federation of Library Associations and Institutions	IWGS	Institute for Women's and Gender Studies	NECC	National Education Coordinating Committee	PDBY	Perdeby
IFNuW	Institute for Food, Nutrition and Well-being	<b>J</b>		NEF	Next Einstein Forum	PDBY	Print, Digital, and Broadcast Youth media
IFREI	International Family-Responsible Employer Index	JCC	Jacaranda Children's Choir	NEHAWU	National Education, Health and Allied Workers' Union	PERKA	Peer-Learning for Emerging Researchers' Knowledge and Advancement
iGaPP	Information Governance and Privacy Protection	JDD	Journal of Decolonising Disciplines	NENU	Northeast Normal University	PET/CT	Positron emission tomography-computed
IHL	Integrated Health Leadership	JHF	Joint Harmonisation Forum	NEP	Noise-equivalent power'	PG	Postgraduate
IIA	Institute of Internal Auditors	JHTT	Joint Harmonisation Task Team	NEPAD	New Partnership for Africa's Development	PHASA	Public Health Association of South Africa
IIPF	International Institute of Public Finance	JICA	Japanese International Cooperation Agency	NEPI	National Education Policy Investigation	PhD	Doctor of Philosophy
ILC	International Law Commission	JSE	Johannesburg Stock Exchange	NEPTTP	National e-Science Postgraduate Teaching and Training Platform	PI	Principal investigator
IMCI	Integrated Management of Childhood Illness	<b>L</b>		nGAP	new Generation of Academics Programme	PIRLS	Progress in International Reading Literacy Study
IMER/ISWEN	Missiological and Ecumenical Research	LAS	Laboratory for Atmospheric Studies	NHCA	Netherdutch Reformed Church of Africa	Pls	Performance indicators
IMF	International Monetary Fund	LEIZ	Leadership Excellence Institute Zeppelin	NHLS	National Health Laboratory Service	PMD	Programme for Management Development
IMMRI	Industrial Metals and Minerals Research Institute	LGSETA	Local Government Sector Education and Training Authority	NICD	National Institute of Communicable Diseases	PMG	Program Maintenance Group
IMRT	Intensity modulated radiotherapy	LIS	Laboratory information system	NIH	National Institute of Health	PNAS	Proceedings of the National Academy of Sciences of the United States of America
INASP	International Network for the Availability of Scientific Publications	LIS	Library Information Services	NIHSS	National Institute for the Humanities and Social Sciences	PODs	Professional Online Development
InSA	Inclusivity South Africa	LLIT	The Living Lab for Innovative Teaching Research	NKP	Normaal Kollege Pretoria	POHC	Primary Oral Health Care Project
INSAR	International Society for Autism Research	LLITUP	Living Lab for Innovative Teaching at the University of Pretoria	NMU	Nelson Mandela University	POPIA	Protection of Personal Information Act
IOC	International Olympic Committee	LLM	International Trade and Investment Law in Africa	NNEP	National Nanotechnology Equipment Programme	POPS	Public Order Police Services
IoD	Institute of Directors	LR	Labour Relations	NNIA	Nestlé Nutrition Institute-Africa	PPE	Politics, Philosophy and Economics
IOFOS	International Organisation for Forensic Odonto- Stomatology	LSSA	Linguistics Society of South Africa	NPHE	National Plan for Higher Education	PQM	Programme Qualification Mix
IPASA	Innovative Pharmaceutical Association of South Africa	LVEF	Left ventricular ejection fraction	NPPSET	National Plan for Post-School Education and Training	PRISA	Public Relations Institute of Southern Africa
IPBES	Intergovernmental Panel on Biodiversity and Ecosystem Services	<b>M</b>		NQF	National Qualifications Framework	PRME	Principles for Responsible Management Education
iPIPS	International Performance Indicators in Primary School	MACE	Marketing, Advancement and Communication in Education	NRF	National Research Foundation	PSET	Post-School Education and Training
IPMA	International Project Management Association	MASUP	Mining Alumni Society of the University of Pretoria	NSC	National Senior Certificate	PTMS	Department of Practical Theology and Missiology Studies
IPS	Industrial and Organisational Psychology	MBA	Master of Business Administration	NSFAS	National Student Financial Aid Scheme	PUA	Pre-University Academy
IR	Institutional Repositories	MCLC	Mamelodi Community of Learning Collaborative	NSP	National Strategic Plan/Framework	PULP	Pretoria University Law Press
IRA	Institutional Research and Analytics	MCP	Mnisi Community Programme	NSTF	National Science and Technology Forum	<b>Q</b>	
IRBA	Independent Regulatory Board for Auditors in South Africa	MDUs	Mobile dental units	NTL	Department of New Testament and Related Literature	QS	Quacquarelli Symonds
IRT	Institutional Research Theme	Medunsa	Medical University of South Africa	NUM	National Union of Mineworkers	QU	Quality Unit
IRTI	International Reformed Theological Institute	MELA	Mining Engineering Leadership Academy	NUMeRI	National Nuclear Medicine Facility	<b>R</b>	
IRTs	Institutional Research Themes	MFDs	multifunction devices	NWU	North-West University	RAG	Reach-out-and-Give
ISAAC	International Society for Augmentative and Alternative Communication	MIMMP	Marion Island Marine Mammal Programme	NZAV	Netherlands-South Africa Foundation	RCVS	Royal College of Veterinary Surgeons
ISC	International Science Council	MINDS	Mandela Institute for Development Studies	<b>O</b>		RDM	Research Data Management
ISCoS	International Spinal Cord Society	MKD	Museums Studies programme	OAU	Organisation of African Unity	RICS	Royal Institution of Chartered Surveyors
ISE	International Society of Electrochemistry's	MMMf	Margaret McNamara Memorial Fund	OCC	Onderstepoort Community Choir	RLC	Research Library Consortium
ISHA	International Society for Hip Arthroscopy	MOMA	Museum of Modern Art	OCR	Optical Character Reader	RSV	Respiratory syncytial virus
ISI	Institute of Scientific	MRI	Mammal Research Institute	OECD	Organisation for Economic Cooperation and Development	RU	Rhodes University
ISIC	Information Seeking in Context			OER	Open Educational Resources		
ISME	International Society for Microbial Ecology						
ISO	International Organization for Standardization						
ISO	International Systems Organisation						
ISORBE	International Society for Radiolabelled Blood Elements						

**S**

SAADP South African Actuarial Development Programme  
 SAAFoST South African Association for Food Science and Technology  
 SAALA Southern African Applied Linguistics Association  
 SAALT South African Association of Language Teaching  
 SAAWK Suid-Afrikaanse Akademie vir Wetenskap en Kuns  
 SABINA Southern African Biochemistry and Informatics for Natural products network  
 SABPP South African Board for Peoples Practices  
 SABR Stereotactic Ablative Radiotherapy  
 SABS South African Bureau of Standards  
 SACC South African Council of Churches  
 SACPCMP South African Council for the Project and Construction Management Professions  
 SACPVP South African Council for the Property Valuers Profession  
 SACQSP South African Council for the Quantity Surveying Profession  
 SACSC South African Council for Shopping Centres  
 SADAG South African Depression and Anxiety Group  
 SADC Southern African Development Community  
 SAELPH South African Executive Leadership Programme in Health  
 SAFA Southern African Finance Association  
 SAFCOL South African Forestry Company Limited  
 SAFIRE South African Identity Federation  
 SAGC South African Geomatics Council  
 SAGV Association of German Studies in Southern Africa  
 SAHELA South African Higher Education Learning Analytics  
 SAHO South Africa History Online  
 SAHRA Heritage Resource Agency  
 SAHRA South African Heritage Resources Agency  
 SAHRC South African Human Rights Commission  
 SAHS Southern African Historical Society  
 SAHUDA South African Humanities Deans' Association  
 SAIA South African Institute for Architecture  
 SAICA South African Institute of Chartered Accountants  
 SAICE South African Institute of Civil Engineering  
 SAICSIT South African Institute for Computer Scientists and Information Technologists  
 SAIDS South African Institute for Drug-free Sport  
 SAIEE South African Institute of Electrical Engineers  
 SAIH's Students' and Academics International Assistance Fund  
 SAIMM Southern African Institute of Mining and Metallurgy  
 SAIW Southern African Institute of Welding  
 SAJAA South African Journal of Anaesthesia and Analgesia  
 SAJEMS South African Journal of Economic and Management Sciences  
 SAJHRM South African Journal of Human Resource Management  
 SALI South African Landscaping Institute  
 SAMRC South African Medical Research Council  
 SAMS South African Mathematical Society  
 SAMTC South African Mathematics Team Competition  
 SANAC South African National AIDS Council  
 SANAS South African National Accreditation System  
 SANEDI South African National Energy Development Institute  
 SANORD Southern African—Nordic Centre  
 SANPAD South Africa-Netherlands Research Programme on Alternatives in Development  
 SANParks South African National Parks  
 SANRAL South African National Roads Agency

SANSA South African National Space Agency  
 SAOA South African Orthopaedics Association  
 SAOC South African Oncology Consortium  
 SAP Systems Applications and Products  
 SAPS South African Police Service  
 SAQA South African Qualifications Authority  
 SARAECE South African Research Association for Early Childhood Education  
 SARB The South African Reserve Bank  
 SARS South African Revenue Services  
 SAS Statistical Analysis System  
 SASA South African Schools Act  
 SASA South African Society of Anaesthesiologists  
 SASBE Sustainable Built Environment Conference  
 SASCA Southern Africa Spinal Cord Association  
 SASCA Stellenbosch Annual Seminar on Constitutionalism in Africa  
 SASHT South African Society of Hand Therapists  
 SASLAW South African Society for Labour Law  
 SASSA South African Social Security Agency  
 SASUF South Africa-Sweden University Forum  
 SATEA South African Tax Educators' Association  
 SATMO South African Tertiary Mathematics Olympiad  
 SAVA South African Veterinary Association  
 SAVC South African Veterinary Council  
 SAWS South African Weather Service  
 SAYAS South African Young Academy of Science  
 SBAH Steve Biko Academic Hospital  
 SCI Spinal cord injury  
 SCITAL Science Teaching and Learning  
 SDGs Sustainable Development Goals  
 SEI Stockholm Environment Institute  
 SEMLI Sport, Exercise Medicine and Lifestyle Institute  
 Senex Senate Executive  
 SERFAC Advisory Board of the India-based Service and Research Institute on Family and Children  
 SET Science, engineering and technology  
 SETI Science, engineering, technology and innovation  
 SHARP Society for the History of Authorship, Reading and Publishing  
 SHCS School of Health Care Sciences  
 SHSPH Health Systems and Public Health  
 SHT Department of Systematic and Historical Theology  
 SIAM Society for Industrial and Applied Mathematics  
 SIGoM Special Interest Group on Multilingualism  
 SIOPSA Society for Industrial and Organisational Psychology in South Africa  
 SITES Second International Technology in Education Study  
 SKA Square Kilometre Array  
 SLA service level agreement  
 SoD School of Dentistry  
 SoLAR Summer Institute of the Society of Learning Analytics Research  
 SoM School of Medicine  
 SPARC Strategic Planning and Allocation of Resources Committee  
 SPECT/CT Single Photon Emission Computed Tomography  
 SPF Sun protection factor  
 SPLUMA Spatial Planning and Land Use Management Act  
 SPMA School of Public Management and Administration

SPMESP Sector Planning, Monitoring, Evaluation and Support Programme  
 SRC Student Representative Council  
 SRM The Department of Science of Religion and Missiology  
 SSAUF Staffing South Africa's Universities' Framework  
 STARS Student Academic Readiness Survey  
 STATOMET Bureau for Statistical and Survey Methodology  
 STEM Science, Technology, Engineering and Maths  
 STIAS Stellenbosch Institute for Advanced Study  
 STIs sexually transmitted infections  
 SU Stellenbosch University  
 SWOT Strengths, weaknesses, opportunities and threats

**T**

T/RDGS Teaching development and research development grants  
 TARG TUKS AIDS Reference Group  
 TB Tuberculosis  
 TEPD Teacher Education and Professional Development  
 THC Tangible Heritage Conservation  
 THE Times Higher Education  
 THRIP Technology and Human Resources for Industry Programme  
 TIA Technology Innovation Agency  
 TILA International Trade and Investment Law for African Lawyers  
 TPCP Tree Protection Co-operative Programme  
 TSC Temporary Student Committee  
 TSCI Traumatic spinal cord injury  
 TSSA Theological Society of South Africa  
 TUC Transvaal University College  
 TUT Tshwane University of Technology  
 TVET Technical and Vocational Education and Training  
 TWAS World Academy of Sciences  
 TWCF Templeton World Charity Foundation  
 TYRLP Tuks Young Research Leader Programme

**U**

UAIT Unit for Academic IT  
 UAL Unit for Academic Literacy  
 UAP Unit for Academic Planning  
 UCDG University Capacity Development Grant  
 UCDP University Capacity Development Programme  
 UCT University of Cape Town  
 UFS University of the Free State  
 UG Undergraduate  
 UGM The Unit for Geoinformation and Mapping  
 UJ University of Johannesburg  
 UK United Kingdom  
 UKZN University of KwaZulu-Natal  
 UN United Nations  
 UNDP United Nations Development Programme  
 UNESCO United Nations Educational, Scientific and Cultural Organization  
 UNFPA United Nations Population Fund  
 Unisa University of South Africa

UP University of Pretoria  
 UP COPC UP Community Oriented Primary Care  
 UP ISMC UP Institute for Sustainable Malaria Control  
 UPAS UP Africa Strategy  
 UPBF University of Pretoria Bargaining Forum  
 UPBI University Business Incubator  
 UP-CIU UP Cochlear Implant Unit  
 UPCSA Uniting Presbyterian Church in Southern Africa  
 UP-CVZ Centre for Viral Zoonoses  
 UPHCSC High Performance Computing Strategy Committee  
 UPNHC UP Natural Hazard Centre  
 UPSA University of Pretoria Staff Association  
 UPSO University of Pretoria Symphony Orchestra  
 UPSW University of Pretoria Symphonic Winds  
 UPWI UP Water Institute  
 UPWO University of Pretoria Workers' Organisation  
 UPYC University of Pretoria Youth Choir  
 URCSA Uniting Reformed Church of South Africa  
 US United States  
 USAf Universities South Africa  
 USAID US Agency for International Development  
 USDP University Staff Doctoral Programme  
 USRN University Social Responsibility Network  
 USSA University Sport South Africa  
 UUC Unit for Urban Citizenship  
 UWC University of Western Cape

**V**

VAT Valued-added Tax  
 VCP Veterinary Core Practice  
 VDG Vehicle Dynamics Group  
 VEP Veterinary Elective Practice  
 VLBI Very large baseline interferometry  
 VPH Veterinary Public Health  
 VPN Virtual Private Network  
 VRC Virtual Reality Centre

**W**

WARG Worship in Africa Research Group  
 WBOTs Ward-based Outreach Teams  
 WHO World Health Organisation  
 WIL Work Integrated Learning  
 Wits University of Witwatersrand  
 WMO World Meteorological Organization  
 WMS WorldShare Management Services  
 WRSA Wildlife Ranching South Africa

**Y**

YALI Young African Leadership Initiative

**Z**

ZSSA Zoological Society of Southern Africa

# Index

## GENERAL TOPICS

### Symbols

#ChooseUP | 426, 499

#FeesMustFall | 4, 5, 8, 10, 17, 18, 19, 20, 24, 25, 31, 34, 43, 44, 48, 51, 62, 73, 93, 96, 183, 237, 247, 304, 305, 307, 326, 329, 365, 386, 418, 422, 434, 444, 468, 469, 476, 481, 488

#UPRising | 21, 22, 25, 45, 96, 481

### A

Academic Achievers' Awards | 113, 121, 152, 219, 242, 290, 306, 344

Academic Ranking of World Universities (ARWU) | 82, 306, 381, 382

Academy of Science of South Africa (ASSAf) | 121, 125, 128, 269, 316, 349, 350, 356, 507

Access (and success) | 4, 5, 7, 8, 10, 11, 16, 17, 25, 45, 59, 63, 64, 65, 68, 74, 93, 107, 131, 132, 133, 142, 164, 200, 217, 227, 232, 236, 254, 259, 267, 270, 273, 277, 279, 300, 305, 348, 362, 407, 408, 424, 434, 435, 440, 441, 447, 450, 453, 454, 456, 460, 465, 468, 476, 477, 478, 481, 482, 483, 485, 486, 487, 490, 516

African Research Universities Alliance (ARUA) | 84, 85, 356, 357

African Science Leadership Programme (ASLP) | 86, 520

Agreement/s | 10, 14, 51, 52, 64, 65, 68, 96, 117, 123, 126, 128, 135, 160, 167, 176, 192, 232, 258, 268, 295, 297, 307, 328, 364, 365, 431, 440, 443, 452, 469, 481, 523, 525, 527

Anchor strategy | 63, 87, 88, 304, 405, 412, 418, 421, 478, 516

Andrew W Mellon Foundation | 86, 236, 249, 451, 505, 525

Anti-discrimination Policy and Manual | 94

Archives | 3, 32, 50, 53, 54, 55, 249

Artificial intelligence (AI) | 175, 176, 340

At-risk students | 74, 422

AU Agenda 2063 | 83, 84

Australia–Africa University Network (AAUN) | 23

### B

Benchmarks | 62, 64, 304, 433

Blended learning | 397, 421, 422, 534

Block grant | 6, 11, 19, 446

Blueprint | 13, 14, 36, 395

Budget/s | 36, 45, 49, 152, 295, 322, 323, 326, 440, 441, 447, 451, 454, 482, 526, 528

Business community | 20, 444

### C

Campus Master Plan | 36, 434

Carnegie Corporation of New York | 178, 323, 422, 467

Citations | 80, 81, 82, 121, 133, 305, 313, 361, 391

Classroom practices | 73, 97, 530

Co-authored papers | 80

Community-based service learning | 215

Community engagement | 13, 41, 45, 60, 87, 125, 128, 172, 191, 197, 198, 200, 201, 202, 203, 205, 256, 262, 264, 268, 277, 279, 280, 288, 300, 303, 305, 312, 329, 330, 270, 393, 405, 411, 418, 419, 420, 421, 461, 487, 542, 544

Community of practice | 43, 185, 200, 353, 381

Community service (see also community engagement) | 108, 185, 190, 278, 299, 327, 387

Comprehensive universities | 6, 64, 65

Contextual imperatives | 16

Council on Higher Education (CHE) | 3, 8, 17, 32, 65, 113, 161, 278, 330, 381, 422, 430, 461

Creative output (see also creative outputs) | ix, 6, 8, 11, 237, 247, 256, 259

Critical citizenry | 21, 60, 73, 87

Curriculum transformation | 73, 97, 98, 106, 127, 272, 305, 489, 502, 530, 532, 533

### D

'Decolonial turn' (also decoloniality) | 530, 533

Decolonising the curriculum | 60, 73, 93, 96, 183, 245

Department of Basic Education (DBE) | 5, 132, 138, 142, 147

Department of Education (DoE) | 4, 5, 7, 8, 65, 74, 131, 135, 140, 142, 147, 195, 261, 387

Department of Higher Education and Training (DHET) | 5, 10, 12, 17, 24, 64, 144, 186, 190, 214, 237, 252, 259, 278, 338, 342, 380, 407, 419, 434, 467, 472, 476, 491

Differentiation | 60, 62, 64, 65, 66, 80, 193

Digitisation | 54, 242

Disability | 17, 131, 202, 269, 434, 486

Disadvantage/disadvantaged | 7, 8, 10, 17, 22, 34, 107, 133, 151, 179, 191, 192, 194, 356, 380, 403, 490, 532

Disruption | 5, 8, 10, 43, 63, 97, 183, 488

Diversity | 13, 14, 15, 16, 17, 20, 38, 42, 49, 59, 60, 63, 64, 65, 69, 70, 72, 73, 93, 94, 98, 106, 107, 109, 138, 143, 145, 160, 175, 238, 242, 255, 262, 268, 281, 305, 319, 338, 359, 364, 365, 366, 367, 371, 375, 379, 404, 408, 417, 424, 451, 452, 483, 485, 489, 490, 491, 512, 530, 532

### E

Early career researchers (see also early career academics, scholars, scientists) | 135, 143, 152, 211, 215, 217, 306, 338, 451, 470, 507, 520, 522

Early Career Research Leadership Fellowship (ECRLF) | 520

Effectiveness | 21, 65, 80, 140, 256, 264, 417, 424, 460

Efficiencies (see also efficiency) | 7, 21, 36, 65, 91, 162, 172, 318, 320, 424, 449, 453

Enrolment (see also enrolment plan and enrolment planning) | 16, 50, 57, 60, 68, 69, 74, 111, 136, 152, 154, 188, 240, 282, 308, 368, 384, 404, 415, 417, 424, 425, 426, 431, 457, 490

Epistemic diversity | 255

Equity and redress | 21, 68, 93

Essential Science Indicators (ESI) | 82, 153, 305

Expert Lecture Series | 90, 152, 363, 507

### F

Faculty Student Advisors (FSA) | 74, 106, 420

Fees Commission | 5, 7, 10

Financial Aid | 5, 6, 30, 49, 132, 420, 447

FlyHigher@UP | 470, 478

FLY@UP ('the finish line is yours') | 74, 304, 420, 460, 478

Full-time equivalent (see also FTE) | 74, 77, 326

Funding | 1, 6, 7, 8, 11, 18, 19, 20, 133, 143, 144, 158, 162, 166, 168, 173, 177, 178, 183, 217, 223, 224, 225, 246, 253, 263, 271, 272

### G

Globalisation (see also global) | 4, 13, 14, 15, 16, 61, 72, 73, 77, 80, 83, 86, 87, 93, 96, 107, 109, 115, 116, 123, 127, 143, 207, 223, 236, 250, 251, 253, 258, 261, 278, 279, 281, 290, 292, 299, 305, 313, 314, 322, 325, 329, 330, 335, 340, 353, 356, 370, 395, 396, 399, 401, 402, 403, 411, 412, 419, 454, 464, 467, 502, 507, 511, 512, 515, 520, 522, 527, 529, 530, 532

Global scientific community | 15

Governance | 6, 19, 31, 32, 33, 34, 38, 39, 44, 45, 47, 48, 50, 52, 54, 64, 73, 107, 122, 142, 252, 271, 273, 277, 279, 294, 299, 344, 356, 379, 397, 417, 428, 453, 462, 481, 487

Graduate attributes | 366

### H

Hatfield City Improvement District (HCID) | 50, 88, 127

Heher Commission | 4, 48

HEMIS data | 16, 63

Higher education landscape | 5, 11, 21, 23, 24, 59, 65, 69, 82, 403, 459, 502, 530

Higher Education Summit | 23, 65, 84

High impact modules | 304, 326

Human capital | 13, 61, 72, 87, 419, 451

Hybrid learning (see also blended learning) | 106, 118, 147, 272, 422

### I

Inaugural address | 13, 20, 87, 363, 370

Independent Transformation Panel of Council | 36, 97

Index/es | 10, 114, 126, 153, 172, 242, 261, 306, 356, 360, 361, 402, 513, 533

Indicators | 65, 78, 82, 147, 153, 187, 305, 378

Information governance | 32, 50, 52, 54, 273

Information Governance and Privacy Protection (iGaPP) | 52, 53

Infrastructure development (see also infrastructure) | 48, 86, 131, 338, 342

Innovation Africa @UP Campus | 528

Insourcing (see also insourcing of campus services) | 10, 19, 36, 45, 96, 434, 449, 452, 479, 481, 482

Institutional culture | 21, 23, 45, 63, 73, 94, 97, 98, 99, 489, 490, 530

Institutional Forum | 29, 30, 32, 39, 42, 43, 44, 50, 95

Institutional imperative | 93

Institutional research themes (IRTs) | 77, 180, 305, 314

Institutional Transformation Committee | 30, 43, 49, 97

International footprint | 4, 340, 432, 508, 513

Internationalisation | 14, 60, 80, 83, 135, 235, 377, 516

International students | 69, 132, 134, 179, 227, 350

### K

King IV Report | 38

Knowledge divides | 14, 17

Knowledge economy | 15

Knowledge fields | 82, 153

Knowledge production | 4, 14, 15, 68, 73, 83, 515, 532

Kresge Foundation | 88, 342, 422

### L

Language of instruction | 24, 36, 96, 97, 489

Language policy | 36, 38, 41, 43, 51, 60, 96, 97, 99, 100, 101, 273, 460, 489

Learning histories | 72, 73

Legacy of colonialism | 24

Legal services | 32, 50, 277, 278, 300

### M

'Make today matter' | 59

Mamelodi Community of Learning Collaborative | 88, 89

Mapungubwe Gold Collection | 19, 86, 245, 266, 268

Marginalised youth | 17

Massification | 3, 5, 16

Mentorship programme | 54, 74, 169, 198

Metrics (see also bibliometrics) | 63, 69, 238, 306, 511, 513

Multidisciplinary (see also interdisciplinary, transdisciplinary) | 13, 118, 159, 164, 170, 176, 194, 197, 204, 215, 236, 264, 310, 334, 337, 348, 356, 393, 428, 433, 454, 462, 504, 515

### N

National Development Plan | 4, 5, 7, 23, 65, 68, 69, 77, 83, 237, 313, 348, 522

Navigational markers | 13, 20, 59, 93, 458

Network | 23, 84, 86, 87, 126, 135, 157, 231, 244, 245, 253, 266, 268, 323, 327, 328, 330, 401, 421, 456, 468

New Generation of Academics Programme (nGAP) | 252, 307, 452

New generation of scholars | 502, 522

Next Einstein Forum | 230, 305, 519

Nexus | 354, 363

NRF-rated (see also NRF rating) | 78, 107, 112, 123, 124, 126, 132, 133, 137, 143, 152, 153, 155, 160, 187, 189, 238, 241, 278, 283, 296, 298, 306, 307, 309, 361, 369, 375, 381, 382, 385, 386, 396, 404, 451

### O

Office of Government Relations and Special Projects (GRaSP) | 88, 497

Online Application System | 426

Online teaching | 10, 178, 278, 304, 321, 337, 422, 496

Open access repository | 456

Optimise Student Services (OSS) project | 424, 472

Order of Mapungubwe | 306, 353

**P**

Paradigm | 147, 340  
 Participation (see also participation rates) | 5, 8, 16, 17, 44, 59, 64, 68, 98, 121, 157, 167, 172, 190, 238, 258, 281, 292, 305, 312, 329, 334, 348, 362, 372, 374, 486, 487, 488, 518  
 PeopleSoft™ | 424, 446, 450, 482  
 Per capita (see also per capita funding, output) | 6, 7, 8, 77, 79, 80, 163  
*Perdeby* | 9, 21, 25, 26, 27, 44, 54, 94, 487  
 Performance indicators | 60, 63, 64, 68, 69, 77, 238, 459, 460  
 Policy development | 4, 21, 93, 280, 486  
 Post-apartheid | 4, 17, 31, 64, 65, 91, 93, 94, 96, 245, 274, 371, 530  
 Post-school education and training | 4, 5, 11, 65, 133  
 Predatory publishing | 8  
 Pre-university programmes | 88, 411  
 Programme and Qualification Mix (PQM) | 8, 140, 461  
 Public good | 3, 24, 60, 73, 87  
 Public sector | 20, 118, 122, 127

**Q**

Quacquarelli Symonds (QS) | 82, 109, 113, 132, 153, 171, 306, 326, 360, 381  
 Quality assurance | 6, 8, 40, 125, 146, 310, 460, 461

**R**

RAG (Reach out and Give) | 44, 45, 487  
*Re-a-bua* dialogues | 94, 95  
 Reconstruction and development | 10, 65  
 Redress | 10, 21, 68, 93, 489  
 Relevance | 3, 4, 11, 13, 20, 21, 59, 60, 68, 73, 74, 76, 77, 85, 93, 116, 118, 124, 125, 127, 133, 135, 166, 170, 183, 193, 249, 288, 313, 316, 325, 326, 348, 362, 367, 379, 412, 487, 502  
 Research capacity | 23, 59, 77, 78, 107, 124, 133, 135, 138, 142, 143, 156, 163, 195, 200, 218, 219, 220, 246, 253, 262, 319, 324, 343, 347, 350, 354, 451, 490  
 Research Chairs | 107, 150, 158, 159, 169, 175, 279, 303, 320, 336, 342  
 Research collaboration | 122, 123, 135, 178, 333, 399  
 Research collections | 55  
 Research Development Grant (RDG) | 7, 451  
 Research entities | 48, 106, 146, 163, 176, 184, 235, 236, 279, 303, 320, 342, 362, 381, 502  
 Research ethics | 30, 40, 235, 252  
 Research-intensive | 4, 15, 46, 52, 59, 60, 63, 65, 68, 72, 76, 77, 80, 85, 178, 180, 183, 210, 211, 236, 237, 270, 277, 281, 303, 343, 391, 392, 407, 464, 502, 504, 520, 530  
 Research-intensive university | 4, 15, 59, 63, 65, 68, 72, 80, 178, 180, 183, 211, 236, 277, 407, 502, 504, 520  
 Research output | 8, 21, 65, 77, 79, 80, 82, 117, 126, 129, 131, 146, 153, 174, 175, 187, 191, 193, 228, 238, 247, 249, 261, 272, 278, 285, 307, 314, 341, 381, 382, 391, 393  
 Research performance | 77, 126  
 Research productivity | 8, 13, 156, 213, 381  
 'Research that matters' | 59  
 Resource-rich environment | 72  
 Responsiveness | 63, 73, 87, 135, 417

Risk management | 19, 41, 52, 109, 116, 193, 457

**S**

Scarce skills (see also specialised skills) | 18, 59, 68, 451  
 Scholarship | 13, 74, 99, 118, 124, 157, 172, 198, 237, 249, 269, 272, 300, 381, 447, 472, 502, 504, 516  
 Science leadership | 85, 86, 472, 520, 522  
 Science platforms (see also research platforms) | 357  
 Shape and size | 4, 20, 59, 60, 68, 307, 459, 460  
 Signature project | 505  
 Social justice | 13, 73, 87, 97, 237, 256, 271, 288, 375, 490, 522  
 Social learning spaces | 98, 172, 441, 489  
 Social responsibility | 87, 101, 125, 198, 370, 403, 515, 516  
 Soudien Report | 17, 94  
 South African Research Chairs Initiative (SARChI) | 107, 122, 157, 158, 161, 163, 175, 176, 185, 186, 220, 284, 291, 293, 298, 299, 305, 320, 334, 336, 339, 340, 342, 347, 348, 350, 351, 352, 353, 381, 388, 389  
 Staff ratio | 112, 132, 137, 153, 155, 189, 241, 283, 309, 326, 369, 385  
 STARS mentorship programme | 74  
 Statute (see also statutory requirements) | 32, 34, 36, 38, 39, 42, 43, 44, 46, 50, 51, 462  
 Steering mechanisms | 6, 64  
 Strategic goals | 21, 62, 63, 64, 66, 68, 74, 80, 93, 134, 197, 203, 278, 337, 417, 424, 427, 444, 449, 458, 459, 460  
 Student Academic Readiness Survey (STARS) | 74, 420  
 Student debt | 8, 10, 18, 51  
 Student governance | 32, 44  
 Student life | 25, 40, 44, 45, 87, 96, 108, 427, 474, 475, 476, 487, 488  
 Student structures | 45, 94, 95, 487  
 Student success (see also throughput) | 4, 7, 8, 16, 17, 18, 26, 44, 60, 64, 68, 69, 72, 74, 96, 98, 99, 109, 111, 128, 136, 151, 152, 154, 162, 168, 188, 194, 200, 240, 256, 281, 282, 294, 295, 304, 305, 307, 308, 359, 368, 370, 381, 384, 397, 402, 404, 407, 408, 410, 417, 419, 420, 422, 423, 458, 460, 467, 470, 472, 474, 483, 484, 490, 492, 511, 512  
*Suid-Afrikaanse Akademie vir Wetenskap en Kuns* | 132, 223  
 Supra-institutional project (see also supra-national project) | 502, 505  
 Sustainability | 7, 13, 15, 19, 20, 36, 59, 63, 65, 87, 157, 159, 170, 245, 263, 292, 307, 313, 317, 325, 335, 344, 354, 359, 417, 440, 444, 453, 482, 512, 518, 522, 530  
 Sustainable Development Goals (SDGs) | 77, 107, 118, 305, 314  
 Sustainable future (see also sustainable futures) | 118, 403  
 Systems Renewal Project | 54, 424, 453, 482

**T**

Targets | 6, 7, 20, 36, 60, 63, 64, 65, 69, 77, 101, 277, 306, 349, 424, 426, 451, 459, 460  
 Teaching Development Grant (TDG) | 7, 420  
 Technical and vocational education and training (TVET) | 5, 133, 214  
 Temporary Student Committees | 36  
 THE Subject Rankings | 83  
 Third-stream income | 18, 48, 168, 300, 364, 446, 470, 482

Throughput | 7, 18, 63, 74, 106, 159, 168, 187, 235, 238, 256, 277, 284, 322, 460, 483  
 Times Higher Education (THE) | 83, 278, 306  
 Traditional universities | 6, 64, 65  
 Transdisciplinarity | 23, 200, 238, 515  
 Transformation | 3, 4, 5, 6, 10, 13, 16, 17, 19, 21, 22, 23, 24, 25, 31, 34, 43, 45, 46, 59, 64, 65, 73, 93, 94, 96, 97, 98, 99, 101, 106, 107, 108, 117, 125, 127, 132, 140, 151, 163, 165, 170, 175, 183, 237, 242, 245, 251, 271, 272, 279, 305, 306, 345, 356, 357, 362, 363, 364, 365, 377, 380, 403, 432, 441, 449, 451, 481, 486, 487, 488, 489, 490, 491, 502, 520, 530, 532, 533  
 Transformation Charter | 21  
 Transformation Implementation Plan | 42, 101, 490  
 Tuition fees | 11, 446, 447  
*Tukkievaria* | 54  
 Tuks Young Research Leader Programme (TYRLP) | 86, 211, 215, 520

**U**

UK Financial Times | 83, 404

## FACULTIES, DEPARTMENTS AND ENTITIES (RESEARCH CHAIRS, CENTRES, INSTITUTES, UNITS)

**A**

Academic Administration, Department of | 273, 417, 425, 426  
 Academic IT, Unit for | 456  
 Academic Literacy, Unit for | 242, 272, 273  
 Academic Planning, Unit for | 417, 457  
 Accounting, Department of | 113, 114, 116  
 Actuarial Science, Department of | 310  
 Actuarial Sciences, ABSA Chair in | 310  
 Adams & Adams Chair in | 289  
 Advanced Corporate and Insolvency Law, Centre for | 293, 296  
 Advanced Study, Institute for | 244, 252  
 Advanced Study, Unit for | 504  
 Advancement of Scholarship, Centre for the | 250, 374, 436, 501, 502, 504, 505  
 African Centre for Gene Technologies | 323  
 African Institute for Mathematical Science (AIMS) | 334  
 African Languages, Department of | 242, 272  
 African Mammalogy, Austin Roberts Chair in | 342, 345, 350  
 African Management and Markets, Centre for | 401  
 African Tax Institute | 107, 109, 120, 122  
 Afrikaans, Department of | 243  
 Agribusiness Management, Barclays Chair in | 317  
 Agriculture, Land Reform and Rural Development, Department of | 316, 317  
 AI Research, Centre for | 251  
 Albert Luthuli Centre for Responsible Leadership (ALCRL) | 107, 118  
 Anaesthesiology, Department of | 209  
 Anatomical Pathology, Department of | 209

Underprepared | 73  
 Universal access | 434, 435, 440, 441  
 Universities of technology | 6, 64, 65  
 UP Campus Tours | 53, 250  
*UP Journey for Change* | 43, 94, 95, 489, 536

**V**

Visibility | 14, 47, 66, 77, 80, 82, 128, 143, 147, 167, 200, 305, 310, 312, 314, 352, 395, 456, 478

**W**

Weighted research output | 8, 77, 79, 153, 238  
 'Wicked problems' | 15, 16  
 Workstreams | 45, 97, 99, 101, 488, 489  
 World rankings | 80, 82, 83, 114, 306  
 World Subject Rankings (see also rankings) | ix, 46, 80, 82, 83, 107, 109, 114, 121, 132, 153, 161, 166, 171, 245, 278, 279, 283, 293, 306, 457

Anatomical Sciences, Department of | 211  
 Anatomy and Physiology, Department of | 386  
 Anatomy, Department of | 210, 211  
 Ancient and Modern Languages, Department of | 243  
 Ancient Languages, Department of | 243  
 Animal and Wildlife Sciences, Department of | 318, 342  
 Animal Breeding, Department of | 318  
 Animal Infectious Diseases (Zoonoses), SARChI Chair in | 186, 220, 320  
 Animal Science, Department of | 318, 319  
 Anthropology, Archaeology and Development Studies, Department of | 245  
 Applications of Mathematics, Centre for | 351  
 Applied Legal Studies, Centre for | 288  
 Applied Mycological Research, Centre for | 509  
 Archaeology, Department of | 268  
 Architecture, Department of | 170, 172, 431  
 Artificial Intelligence Research in Statistics, Centre for | 340  
 Artificial Intelligence, SARChI Chair in | 175, 176  
 Arts and Culture, Department of | 273  
 Arts, Department of | 273, 513  
 Asset Integrity Management, Centre for | 166  
 Auditing, Department of | 113, 114, 116, 463  
 Augmentative and Alternative Communication (CAAC), Centre for | 268  
 Australian Institute of Building | 172

**B**

Banking Law in Africa, Absa Chair in | 280, 289, 293, 296  
 Basic Education, Department of | 5, 132, 138, 142, 147  
 Biblical and Religious Studies, Unit for | 370  
 Big Data and Data Science, Institute of | 175  
 Biochemistry, Department of | 320, 327, 353  
 Biochemistry, Genetics and Microbiology, Department of | 320, 337, 349, 460

Bioinformatics and Computational Biology, Centre for | 320, 323  
 Biokinetics and Sports Science, Division of | 228, 337  
 Biomedical Sciences, Department of | 392  
 Biostatistics, Department of | 347  
 Biostatistics, SARChI Chair in | 347  
 Business Analysis and Research, Centre for | 401  
 Business and Professional Ethics, Centre for | 251  
 Business Intelligence, Division of | 457  
 Business Management, Department of | 106, 116, 117, 118, 126

**C**

Campus Services, Division of | 443  
 Carbon Technology and Materials, Chair in | 157, 158, 347, 348  
 Carbon Technology and Materials, SARChI Chair in | 157, 347, 348  
 Carl and Emily Fuchs Institute for Microelectronics (CEFIM) | 162  
 Cellular and Molecular Medicine, Institute for | 185, 217, 320, 324  
 Cellular Differentiation and Transformation, Department of | 230  
 Chartered Financial Analyst (CFA) Institute | 124  
 Chartered Institute of Building | 172  
 Chartered Institute of Management Accountants | 109  
 Chemical Engineering, Department of | 151, 152, 156, 158  
 Chemical Pathology, Department of | 212, 213  
 Chemistry, Department of | 325  
 Child Law (CCL), Centre for | 293, 294  
 Church History and Church Polity, Department of | 362, 366, 370  
 Civil Engineering, Department of | 159, 160  
 Clean and Green Energy, SARChI Chair in | 348  
 Communication Management, Division for | 106, 117  
 Communication Pathology, Department of | 263  
 Communications, Department of | 178  
 Community Dentistry, Department of | 191, 192  
 Community Oriented Primary Care Research Unit | 186  
 Community Studies, Centre for | 99  
 Companion Animal Clinical Studies, Department of | 386  
 Computational and Methodological Statistics, SARChI Chair in | 340  
 Computer Science, Department of | 175, 176  
 Computer Scientists and Information Technologists, Institute for | 152  
 Conservation Ecology, Chair in | 342  
 Conservation Ecology Research Unit (CERU) | 346  
 Conservation Physiology, SANBI-UP SARChI Chair in | 342, 353  
 Construction Economics, Department of | 152, 172, 173  
 Construction Industry Institute | 180  
 Consumer and Food Sciences, Department of | 307, 327, 441  
 Consumer Science, Department of | 327  
 Contextual Ministry (CCM), Centre for | 364  
 Continuing Education, Centre for | 272  
 Corporate Communication and Marketing, Department of | 497  
 Creative Writing, Unit for | 247, 274  
 Critical Care, Department of | 212  
 Cybersecurity, DRS Chair in | 176

**D**

Dance and Musical Theatre, Department of | 256  
 Data Science, ABSA-UP Chair in | 176

Dental Management Sciences, Department of | 192  
 Dentistry, Faculty of | 190  
 Dermatology, Department of | 213  
 Development Institute for the Deaf and Blind | 144  
 Development Studies, Institute for | 157, 356  
 Digital Language Resources, Centre for | 242  
 Distance Education, Unit for | 140  
 Division of the National Health Laboratory Service | 216  
 Dogmatics and Christian Ethics, Department of | 364, 366, 371  
 Drama, Department of | 267  
 Dynamic Markets, Centre for | 397, 401

**E**

Early Childhood Education, Department of | 138  
 Ear, Nose and Throat, Department of | 225  
 Economic and Management Sciences (EMS), Faculty of | 105, 251, 340, 341, 463  
 Economics, Department of | 105, 120, 121  
 Educational Psychology, Department of | 135, 142, 143, 144  
 Education, Department of | 4, 5, 7, 8, 65, 74, 131, 135, 140, 142, 147, 195, 261, 387  
 Education Innovation, Department of | 74, 131, 195, 387  
 Education Law in Africa, UNESCO Chair in | 293, 297  
 Education Management and Policy Studies, Department of | 131, 135, 140, 142  
 Electrical, Electronic and Computer Engineering, Department of | 152, 162, 163, 176  
 Electromagnetism, Centre for | 161, 162  
 Electronics, CBI Chair in | 162  
 Energy, Department of | 162, 324  
 Energy Economics, Institute for | 180  
 Energy Efficiency, Exxaro Chair in | 161, 162  
 Engineering and Technology Management, Department of | 178  
 Engineering, Built Environment and Information Technology (EBIT), Faculty of | 149, 329, 348, 523, 526  
 English, Department of | 26, 247, 274  
 Enrolment and Student Administration, Department of | 50, 417, 424, 426  
 Environmental Chemical Pollution and Health Research, Unit for | 185, 233  
 Environmental Economics and Policy in Africa (CEEPA), Centre for | 312, 316  
 Environmental Studies (CFES), Centre for | 329, 330  
 Epidemiological Criminology, Centre for | 263  
 Epidemiological Modelling and Analysis, Centre for | 351  
 Equine Research Centre | 378, 381, 382  
 Eskom Power Plant Engineering Institute | 167  
 Ethics and Philosophy of Health Sciences, Centre for | 186, 208  
 European Union Studies, Jean Monnet Chair in | 252  
 Evaluation and Assessment (CEA), Centre for | 133, 146, 147  
 Exotic Leather Research, Centre for | 378, 381

**F**

Facilities Management, Department of | 49  
 Family Medicine, Department of | 186, 200, 214, 215  
 Finance, and Business Enterprises, Department of | 425  
 Finance, Department of | 444, 447, 518

Financial Management, Department of | 123, 124  
 Fluoromaterials Science and Process Integration, SARChI Chair in | 158  
 Food Science, Department of | 327  
 Forensic and Investigative Accounting, Unit for | 107, 113, 116  
 Forensic Anthropology, Research Centre for | 185, 211  
 Forensic Medicine, Department of | 215, 295  
 Forest Genomics and Biotechnology, Sappi and Mondri Chair in | 324  
 Forestry and Agricultural Biotechnology Institute (FABI) | 306, 320, 324, 342, 349, 354, 502, 529  
 Future Africa, Institute | 19, 23, 51, 84, 85, 86, 211, 307, 352, 442, 446, 501, 502, 503, 507, 514, 515, 516, 518, 519, 520, 521, 522, 527

**G**

Genetics, Department of | 320, 324, 325  
 Genomics Research Institute | 305, 320, 322, 325  
 Geodynamics, Exxaro Chair in | 332, 333  
 Geography, Geoinformatics and Meteorology, Department of | 328, 330  
 Geoinformation and Mapping, Unit for | 328  
 Geology, Department of | 332, 333  
 Gordon Institute for Business Science (GIBS) | 62, 272

**H**

Haematology, Department of | 216  
 Health and Social Development, Department of | 294  
 Health, Department of | 185, 210, 214, 220, 320, 451  
 Health Professions, Institute of | 200  
 Health Sciences, Faculty of | 145, 183, 184, 185, 186, 187, 190, 197, 204, 206, 207, 208, 210, 212, 215, 218, 219, 220, 221, 228, 231, 295, 320, 338, 342, 347, 353, 439, 451, 465  
 Higher Education and Training, Department of | 5, 10, 12, 17, 24, 64, 144, 186, 190, 214, 237, 252, 259, 278, 338, 342, 380, 407, 419, 434, 467, 472, 476, 491  
 Higher Education Transformation, Centre for | 65  
 Historical and Heritage Studies, Department of | 53, 237, 245, 249  
 Human Genetics, Department of | 320  
 Humanities Education, Department of | 144, 145  
 Humanities, Faculty of | 138, 229, 235, 237, 238, 249, 252, 253, 257, 264, 269, 272, 273, 274, 329, 338, 362, 374, 375, 460, 465, 525, 532  
 Human Nutrition, Department of | 199  
 Human Resource Management, Department of | 124  
 Human Resources, Department of | 52, 449  
 Human Rights, Centre for | 99, 277, 279, 281, 284, 288, 291, 292, 293, 299, 300, 522

**I**

Immunology, Department of | 216, 217  
 Industrial and Systems Engineering, Department of | 152, 164  
 Industrial Engineering, Department of | 163  
 Industrial Metals and Minerals Research Institute (IMMRI) | 165  
 Infectious Diseases and Immunology, Department of | 393  
 Inflammation and Immunity, Unit for | 217  
 Informatics, Department of | 164, 176

Information Governance, Unit for | 52, 273  
 Information Science, Department of | 177, 178, 242  
 Information Technology Services, Department of | 477  
 Insolvency, Labour and Corporate Law (CILC), Centre for | 293  
 Institutes for Advanced Study | 244, 252  
 Institute for International Peace Studies | 252  
 Institute for Mathematical Sciences (AIMS) | 519  
 Institute of Information Technology Professionals | 400  
 Institute of Internal Auditors (IIA) | 462  
 Institute of Molecular Biology and Genetics | 324  
 Institute of Scientific Information | 306  
 Institute of Tropical Medicine (ITM) | 381, 392  
 Institutional Advancement, Department of | 496  
 Institutional Planning, Department of | 16, 21, 417, 427, 457, 459, 462, 469, 484  
 Insurance Law and Governance, Unit for | 293  
 Intellectual Property Law, Adams & Adams Chair in | 289, 293, 295  
 Intellectual Property Law, Centre for | 289, 295  
 Internal Auditing Excellence, Centre for | 114  
 Internal Auditors (IIA), Institute of | 114  
 Internal Audit, Unit for | 462, 463  
 Internal Medicine and Paediatrics, Department of | 216  
 Internal Medicine, Department of | 217  
 International and Comparative Law in Africa (ICLA), Institute for | 280, 291, 292, 293  
 International Development Law and African Economic Relations, SARChI Chair in | 284, 291, 293, 298, 299  
 International Development Law Unit (IDLU) | 298  
 International Insolvency Institute | 296  
 International Institute of Public Finance | 120  
 International Mobility, Centre for | 258  
 International Peace Studies, Institute for | 252  
 International Reformed Theological Institute | 371  
 International Relations and Cooperation, Department of | 253  
 International Statistical Institute (ISI) | 352  
 Itsoseng Psychology Clinic | 411

**J**

Japanese Studies, Centre for | 138, 272  
 Jurisprudence, Department of | 287, 288  
 Justice, Department of | 295

**L**

Laban/Bartenieff Institute of Movement Studies | 256  
 Land Surveying, Department of | 174  
 Law and Medicine, Centre for | 293, 295  
 Law, Faculty of (see also UP Law) | 50, 268, 273, 277, 287, 288, 290, 374, 465, 533  
 Leadership and Dialogue, Centre for | 402  
 Leadership and Transformation, Department of | 20  
 Leadership Excellence Institute Zeppelin | 117  
 Learning Analytics Summer Institute | 422  
 Legal History, Department of | 287  
 Lessac Research and Training Institute | 256  
 Library Services, Department of | 464  
 Lincoln Institute of Land Policy | 120, 122

**M**

Machine Learning, MultiChoice Joint Chair in | 175  
 Malaria Research, SAMRC Collaborating Centre | 185  
 Mammal Behavioural Ecology and Physiology, SARChI Chair in | 350  
 Mammal Research Institute (MRI) | 318, 320, 342, 344, 391  
 Marketing and Communication Management, Department of | 106, 126, 127  
 Marketing Management, Department of | 106, 109, 126  
 Market Research, Unit for | 417, 457  
 Materials Science and Metallurgical Engineering, Department of | 151, 164, 166, 169  
 Maternal and Infant Health Care Strategies, Unit for | 204  
 Maternal, Foetal, Newborn and Child Health Care Strategies, Unit for | 223  
 Mathematical Models and Methods in Bioengineering and Biosciences, SARChI Chair in | 334, 347, 350  
 Mathematics and Applied Mathematics, Department of | 333, 350  
 Mathematics, Department of | 441  
 Mathematics, Faculty of | 334  
 Maxillo-facial and Oral Surgery, Department of | 193  
 Max Planck Institute for Comparative Public and International Law | 299  
 Max Planck Institute for the History of Science | 260  
 Mechanical and Aeronautical Engineering, Department of | 167  
 Mechanical Engineering, Rand Water Chair in | 167  
 Media Communication and Information Studies, Department of | 99  
 Mediation in Africa (CMA), Centre for | 252, 253  
 Medical Microbiology, Department of | 218  
 Medical Oncology, Department of | 219  
 Medical Virology, Department of | 186, 219  
 Medicine, Faculty of | 190, 199  
 Meraka Institute | 163  
 Mercantile Law, Department of | 279, 288, 292, 293, 296, 297  
 Metallurgical Engineering, Department of | 150  
 Microbial Ecology and Genomics (CEMG), Centre for | 320, 324, 325  
 Microbiology and Plant Pathology, Department of | 320, 338  
 Microbiology, Department of | 325  
 Mine Design, Centre for | 167  
 Minerals Processing, Tenova-Bateman Chair in | 165, 166  
 Mine Safety, Health and Environment, Sasol Chair in | 169  
 Mining and Metallurgy, Institute of | 152  
 Mining Engineering, Department of | 34, 152, 167, 170, 177  
 Mining Resilience Research (MRRRC), Centre for | 170  
 Missiological and Ecumenical Research, Institute for | 364  
 Modern European Languages, Department of | 243  
 Monetary Economics, South African Reserve Bank (SARB) Chair in | 120, 123  
 Music, Department of | 257, 267

**N**

National Institute for the Humanities and Social Sciences | 237, 259, 263, 269  
 National Institute of Communicable Diseases | 218

National Institute of Deafness and Other Communication Disorders | 269  
 National Zoological Gardens SARChI Research Chair: Conservation Physiology | 353  
 Natural and Agricultural Sciences (NAS), Faculty of | 303, 310, 328, 340, 391, 460, 508, 529  
 Nestlé Nutrition Institute-Africa | 199  
 Neuroendocrinology, Centre for | 186, 342  
 Neurology, Department of | 220  
 Neurosurgery, Department of | 221  
 New Energy Systems (CNES), Centre of | 161, 162  
 New Testament and Related Literature, Department of | 366, 372  
 New Testament Studies, Department of | 372  
 Nova Institute | 361  
 Nuclear Medicine, Department of | 221, 222  
 Nursing Science, Department of | 200  
 Nutrition and Food Security, SARChI Chair in | 352

**O**

Obstetrics and Gynaecology, Department of | 209, 222, 223  
 Occupational Therapy, Department of | 198, 201  
 Odontology, Department of | 194  
 Old Testament and Hebrew Scriptures, Department of | 366  
 Ophthalmology, Department of | 223, 224  
 Oral Pathology and Oral Biology, Department of | 194  
 Orthodontics, Department of | 195, 196  
 Orthopaedics, Department of | 224, 225  
 Orthopaedic Surgery, Department of | 225  
 Otorhinolaryngology, Department of | 225, 226

**P**

Paediatrics and Child Health, Department of | 226  
 Paraclinical Sciences, Department of | 391  
 Pathology, Institute of | 216  
 Periodontics and Oral Medicine, Department of | 196  
 Pharmacology, Department of | 227, 228  
 Pharmacy, Faculty of | 328  
 Philosophy and Ethics of Mental Health, Nelson Mandela Chair in | 186  
 Philosophy and Psychiatry, Chair in | 231  
 Philosophy, Department of | 251, 270  
 Physics, Department of | 78, 158, 335, 348  
 Physiology, Department of | 228, 229, 230, 336, 337  
 Physiotherapy, Department of | 197, 202  
 Planning, Monitoring and Evaluation, Department of | 313  
 Plant and Soil Sciences, Department of | 320, 321, 338, 339, 352  
 Plant Asset Management, Centre for | 167  
 Plant Asset Management, Eskom Chair in | 166  
 Plant Health Products from Indigenous Knowledge Systems, SARChI Chair in | 339, 352  
 Plant Physiology, Department of | 54  
 Plant Production and Soil Science, Department of | 338, 340  
 Plant Science, Department of | 338  
 Political Sciences, Department of | 252  
 Power Electronics, CBI Chair in | 161, 162  
 Practical Theology and Missiology Studies, Department of | 366  
 Practical Theology, Department of | 363, 364, 366, 374

Private Law, Department of | 280, 289, 294, 295  
 Procedural Law, Department of | 280, 290, 295, 299  
 Production Animal Studies, Department of | 388  
 Prosthodontics, Department of | 196, 197  
 Psychiatry, Department of | 186, 230, 231  
 Public Health and Water, Rand Water Chair in | 186  
 Public Health Medicine, Department of | 204, 205, 206  
 Public Law, Department of | 280, 281, 288, 290, 292, 294, 295, 299  
 Public Relations Institute | 126  
 Public Theology, Centre for | 364, 371  
 Pyrometallurgical Modelling, Glencore Chair in | 165, 166  
 Pyrometallurgy, Anglo American Chair in | 165  
 Pyrometallurgy, Centre for | 165

**R**

Radiation Oncology, Department of | 231  
 Radiographic Science, Department of | 197  
 Radiography, Department of | 203, 204  
 Reconciliation and Social Justice, Institute for | 101  
 Religion and Missiology, Department of Science of | 363, 366, 375  
 Religion and Society, Centre for | 364, 366  
 Religion Studies, Department of | 366  
 Rensselaer Polytechnic Institute | 259  
 Research and Decision Support, Centre for | 351  
 Research and Innovation, Department of | 51, 134, 452, 470  
 Research on Women, Centre for | 270  
 Residence Affairs and Accommodation, Department of | 452, 474, 476  
 Responsible Leadership, Centre for | 107, 118, 251  
 Rock Engineering and Numerical Modelling, Harmony Gold Chair in | 169

**S**

Safety and Security, Department of | 263  
 Science and Innovation, Department of | 511  
 Science and Technology, Department of | 4, 8, 86, 121, 125, 143, 158, 200, 251, 271, 306, 347, 511  
 Science, Mathematics and Technology Education, Department of | 133, 146, 326  
 Science of Religion and Missiology, Department of | 363, 366, 375  
 Scientific and Industrial Research, Centre for | 147  
 Security Services, Department of | 478, 479, 481  
 Social Development, Department of | 295  
 Social Work and Criminology, Department of | 215, 262, 263  
 Social Work, Department of | 261  
 Social Work, Institute of | 262  
 Sociology, Department of | 260, 261, 270  
 South African Chemical Institute | 306, 326  
 South African Institute for Drug-free Sport | 290  
 South African Institute for International Affairs | 299  
 South African Institute of Chartered Accountants | 32, 109, 113, 115, 124, 129, 462  
 South African Institute of Civil Engineering | 152, 173  
 South African Institute of Tax Professionals | 109

South African Landscaping Institute (SALI) | 443  
 South African National Energy Development Institute | 162  
 South Africa-Sweden University Forum (SASUF) | 84  
 Southern African Institute of Welding | 151, 165  
 Speech-Language Pathology and Audiology, Department of | 263, 431  
 Sport, Exercise Medicine and Lifestyle (SEMLI), Institute for | 184, 185  
 Sport Sciences, Centre for | 184  
 Standards, Bureau of | 330  
 Stanford Woods Institute for the Environment | 520  
 State Security, Department of | 252  
 Statistical Analysis System (SAS) Institute | 341  
 Statistical and Survey Methodology (STATOMET), Bureau for | 340, 341  
 Statistics, Department of | 340, 341, 347, 441  
 Stockholm Environment Institute | 128  
 Strategic and Political Affairs (ISPA), Institute for | 252  
 Strategic Studies, Institute for | 252  
 Student Affairs, Department of | 45, 49, 430, 441, 483, 484, 498  
 Study of Governance Innovation (GovInn), Centre for the | 252, 271, 505  
 Study of Resilience, Centre for the | 133, 143  
 Surgery, Department of | 232  
 Sustainable Malaria Control, Centre for | 185  
 Sustainable Malaria Control, SARChI Chair in | 320, 347, 353  
 Sustainable Malaria Control, UP Institute for | 157, 185, 320, 351  
 Synergos Institute | 143  
 Systematic and Historical Theology, Department of | 366  
 Systematic Theology and Ethics, Department of | 370

**T**

Tax and Development, Centre for | 122  
 Taxation, Department of | 109, 128, 129  
 Telecommunication Engineering for the Information Society, Centre for | 161, 162  
 Telecommunications and Postal Services, Department of | 178  
 Teletraffic Engineering for the Information Society, Centre for | 162  
 Theology and Religion, Faculty of (see also Faculty of Theology) | 359, 360, 365, 366, 370, 375  
 Tourism Management, Department of | 106, 126  
 Tourism Management, Division of | 126  
 Trade and Industry, Department of | 289, 511  
 Training in Integrated Livestock and Wildlife Health and Management, Centre for | 392, 393  
 Transport, Department of | 126  
 Transport Development, Centre for | 164

**U**

University of Ontario Institute of Technology | 135  
 University Relations, Department of | 54, 496, 497  
 UP Archives (see also Archives) | v, 3, 32, 50, 53-55  
 UP Arts, Department of | 264  
 UP Law (see also Faculty of Law) | 277, 284, 288, 291, 292, 294, 295, 296, 300  
 UP Natural Hazard Centre (UPNHC) | 332, 333

UP Water Institute | 320  
 Urban Citizenship, Unit for | 172  
 Urology, Department of | 185, 233  
 US National Institute of Health | 269  
 US Project Management Institute | 180

**V**

Veterinary Medicine, Faculty of | 393  
 Veterinary Science, Faculty of | 345, 377, 378, 379, 382, 386, 390  
 Veterinary Tropical Diseases, Department of | 381, 382, 392  
 Veterinary Wildlife Studies | 345, 378, 381  
 Veterinary Wildlife Studies, Centre for | 378  
 Visual Arts, Department of | 249, 259, 524

**PEOPLE****A**

Abdool, Zeelha (Z) | 223  
 Abernethy, Darrell (DA) | 377, 378, 392  
 Abidoeye, Babatunde (B) | 316  
 Abolnik, Celia (C) | 381, 389  
 Abul-Feilat, Rasmi (RA) | 233  
 Adamson, Joni (J) | 507  
 Adam, Sumaiya (S) | 22, 23, 99, 208, 223, 332  
 Adendorff, Susan (SA) | 433  
 Adeyemo, Samuel (S) | 142  
 Alava, Jukka (J) | 140  
 Alberts, Andrie (A) | 209  
 Alfa, Attahiru (A) | 161, 163  
 Alisic, Eva (E) | 520  
 Altermann, Wlady (W) | 332, 333  
 Aluko, Ruth (R) | 143  
 Ampofo, Akosua (AA) | 507  
 Amsterdam, Christian (C) | 135, 371, 375  
 Anderson, Ronnie (R) | 186, 216, 217  
 Anderson, Ross (RC) | 186, 216, 217  
 Aneck-Hahn, Natalie (NH) | 185, 233  
 Annandale, Henry (CH) | 377  
 Annandale, John (JG) | 338  
 Antonites, Alex (AJ) | 116  
 Archbishop, Thabo (TC) | 361  
 Arendse, Lorette (L) | 288  
 Asholi, Ahmed (AAO) | 223  
 Asrie, Paul (P) | 446  
 Atiemo, Abamfo (AO) | 363  
 Avenant, Theuns (TO) | 226  
 Awuah, Joyce (J) | 446

**B**

Baboolal-Frank, Rashri (R) | 290  
 Badenhorst, Hein (H) | 152, 157  
 Bahula, Jacob (J) | 150

**W**

Waste Water Management, East Rand Water Care Company Chair in | 158  
 Water Utilisation Engineering, Rand Water Chair in | 158  
 Water Utilisation Engineering, Sedibeng Water Chair in | 158  
 WHO Collaborating Centre for Social Determinants of Health and Health in All Policies | 206  
 Wildlife Ecology and Conservation, Department of | 346  
 Wildlife Management, Centre for | 318, 342  
 Wildlife Management, Eugène Marais Chair of | 318  
 Women's and Gender Studies, Institute for | 261  
 Work and Life, Centre for | 261  
 World University Rankings, Centre for | 306

**Z**

Zoology and Entomology, Department of | 330, 342, 343, 345, 346, 350, 353

Bakker, Karel (KA) | 170, 171, 524, 525  
 Ballim, Yunus (Y) | 43  
 Ball, Steven (S) | 493  
 Baloyi, Lawrence (L) | 51, 470, 471  
 Banasiak, Jacek (J) | 334, 351  
 Bansal, Ramesh (R) | 162  
 Barac, Karin (K) | 114, 115  
 Barker, Nigel (NP) | 339  
 Barnard, Helena (H) | 396  
 Barnard, Jacolien (J) | 266, 289  
 Barnard, Marcel (M) | 363  
 Barnard, Monique (M) | 300  
 Barnes, Irene (I) | 306  
 Baskerville, Richard (RL) | 177  
 Bastos, Armanda (ADS) | 342, 344, 351  
 Basu, Debashis, D(D) | 206  
 Becker, Hennie (JHR) | 232  
 Becker, John (JVW) | 323  
 Beckman, Johan (JL) | 131, 140  
 Behr, Danie (DM) | 35  
 Behrens, Reinher (R) | 497  
 Bekink, Bernard (B) | 291  
 Bekker, Andriette (A) | 340  
 Bekker, Thino (T) | 290  
 Belle, Bharath (B) | 167  
 Benatar, David (D) | 22, 23  
 Bengu, Sibusiso (SME) | 65  
 Bennett, Nigel (NC) | 306, 342, 343, 344, 345, 350, 351  
 Berger, Dave (DK) | 306, 338  
 Berges, Ulrich (U) | 373  
 Bergh, Anne-Marie (AM) | 204  
 Bernitz, Herman (H) | 195  
 Berry, Donagh (DP) | 319  
 Bester, Marthan (MN) | 342, 343  
 Bester, Megan (MJ) | 210  
 Bester, Nicolaas (N) | 433, 434  
 Best, Peter (PB) | 342  
 Beuken, Wim (WAM) | 363, 373  
 Beyers, Conrad (FJC) | 310, 311, 312

Beyers, Jaco (J) | 362, 375  
 Bezuidenhout, Hannes (H) | 107, 116  
 Bezuidt, Oliver (OKI) | 323  
 Bhana, Varshika (V) | 200  
 Bhayat, Ahmed (A) | 191  
 Bida, Meshack (NM) | 209  
 Biggs, Rory (R) | 334  
 Binedell, Nick (N) | 91, 395, 403  
 Bipath, Keshni (K) | 135  
 Birkholtz, Lyn-Marie (LM) | 185, 320, 353  
 Björk, Lars (LG) | 141, 317  
 Blignaut, Chris (C) | 317  
 Blokland, Linda (LME) | 484, 485  
 Bloomer, Paulette (P) | 320  
 Blore, Megan (M) | 316  
 Blumenthal, Ryan (R) | 216  
 Blundell, Richard (R) | 120  
 Blunden, Chris (C) | 207  
 Boeyens, Jan (J) | 507  
 Boezaart, Trynie (CM) | 277, 289, 290, 294  
 Bond-Barnard, Taryn (T) | 180  
 Bookhan, Vinesh (V) | 194, 208  
 Boonzaaier, Johan (JCN) | 478, 479  
 Booysen, Ingrid (I) | 328  
 Booysen, Steve (SF) | 35  
 Boraine, André (A) | 277, 278, 281, 290, 296  
 Bornman, Dawie (D) | 116  
 Bornman, Riana (MS) | 233  
 Boshoff, Sanette (S) | 457, 459  
 Boshomane, Gill (TMG) | 222  
 Bosman, Marius (MC) | 210, 211  
 Botha, Anton (AD) | 35  
 Botha, Christo (CJ) | 277, 290, 391  
 Botha, Esther (E) | 389  
 Botha, Herman (H) | 445, 446  
 Botha, Louw (LS) | 450  
 Botha, Monray (MM) | 288  
 Botha, Piet (BP) | 35  
 Botha, Piet (P) | 195  
 Bothma, Salome (S) | 218  
 Bothma, Theo (TJD) | 149, 175, 177  
 Bourblanc, Magalie (M) | 316  
 Boy, Sonya, (S) | 195  
 Bradley, Andrew (A) | 232  
 Bradlow, Danny (DD) | 284, 285, 293, 298, 299  
 Brandt, Paul (PD) | 194  
 Braun, Max (MWH) | 131, 146  
 Bray, Elmene (W) | 141  
 Breed, Ida (CA) | 171  
 Breedt, André (A) | 523, 524  
 Breetzke, Greg (GD) | 329, 330  
 Bresser, Phillipa (PL) | 204  
 Breytenbach, Andries (APB) | 363  
 Brits, Reghard (R) | 289, 296  
 Browne-Ferrigno, Tricia (T) | 141  
 Buchanan, Glynn (GD) | 194  
 Buch, Eric (E) | 97, 183, 184, 197, 204, 207, 232  
 Budree, Reena (R) | 449

Buitendag, Johan (J) | 359, 360, 361, 364, 366, 370, 371  
 Bumbay, Adam (AJ) | 332  
 Bunn, Belinda (BK) | 195  
 Buque, Vulyelwa (B) | 228  
 Burdzik, Walter (WMG) | 159  
 Burger, Michelle (M) | 173  
 Burton, Stephanie (SG) | 47, 496, 518  
 Buscombe, John (JR) | 222  
 Bütow, Kurt (KW) | 193  
 Buys, Elna (EM) | 84, 327, 328  
 Buys, Tania (T) | 201

**C**

Callaghan, Ronel (P) | 147  
 Cameron, Elissa (EZ) | 342, 343, 344  
 Campaini, Cinzia, (C) | 209  
 Cappiello, Joyce (J) | 200  
 Carrim, Nasima (N) | 125  
 Carstens, Adelia (A) | 131, 144, 272, 273  
 Carstens, Pieter (PA) | 291, 293, 295  
 Casey, Norman (NH) | 318  
 Cassim, Femida (FM) | 260, 289, 296, 300  
 Chagwinya, Nyaradzo (N) | 292  
 Chamunorwa, Joseph (JP) | 377, 386  
 Chapwanya, Michael (M) | 351  
 Chen, Ding-Geng (DG) | 347  
 Chengadu, Shireen (S) | 402, 497  
 Chetty, Nithaya (N) | 336  
 Chinyio, Ezekiel (E) | 173  
 Chipp, Kerry (K) | 396  
 Chirwa, Evans (EMN) | 158  
 Chirwa, Paxie (PW) | 339  
 Chitiga-Mabugu, Margaret (M) | 127, 128  
 Cilliers, Amelia (A) | 519  
 Claasen, Schalk (SJ) | 163, 433, 434, 523  
 Cleghorn, Ailie (A) | 135  
 Cloete, Chris (CE) | 173, 392  
 Cloete, Madelyn (M) | 113  
 Cloete, Rian (R) | 290, 293, 295  
 Cockeran, Riana (R) | 216  
 Coetzee, Anton (A) | 523  
 Coetzee, Hannelie (MH) | 484, 486  
 Coetzee, Hennie (HS) | 433  
 Coetzee, Hermie (HL) | 289, 296  
 Coetzee, Isabel (IM) | 200  
 Coetzee, Johan (J) | 150  
 Coetzee, Johnny (J) | 174  
 Coetzee, Petrus (PF) | 232  
 Coetzee, Serena (SM) | 328, 330  
 Coetzee, Stephen (SA) | 113, 114  
 Coetzee, Vinet (V) | 305  
 Coetzer, Koos (JAW) | 377, 392  
 Collins, John (JJ) | 373  
 Combrinck, Sias (S) | 445  
 Combrink, Caren (C) | 172  
 Combrink, Celeste-Marié (C-M) | 132, 147  
 Cooper, Anthony (A) | 330  
 Cooper, Rob (R) | 184

Cordier, Werner (W) | 228  
 Cornelius, Steve (SJ) | 289, 290, 293, 295  
 Cornell, Drucilla (DL) | 278, 288  
 Cowan, Don (DA) | 306, 322  
 Crafford, Elmine (E) | 196  
 Craig, Ian (IK) | 161  
 Crewe, Robin (RM) | 47, 91, 306, 323, 343, 504, 505, 507, 512, 518  
 Cromarty, Duncan (AD) | 327  
 Cronjé, Zabeth (Z) | 231  
 Crouse, Philip (PL) | 158  
 Crowther, Nico (NAS) | 340  
 Cruywagen, Hoffie (H) | 172, 173  
 Cukrowski, Ignacy (I) | 305  
 Curlewis, Llewelyn (LG) | 290  
 Czenze, Zenon (ZJ) | 354

## D

Dabrowski, Joel (JJ) | 310, 312  
 Da Gama, Tiffaney (T) | 53  
 Dantas, Jaya (JR) | 200  
 Das, Sonali (S) | 117  
 Davey, Calayde (C) | 171  
 Davidson, Christy (C) | 195  
 Davies-Mostert, Harriet (HT) | 345  
 Davis, Nerhene (NC) | 329  
 Dawjee, Salahuddin (S) | 195  
 Deane, Roger (R) | 336  
 De Beer, Chris (CR) | 36, 46, 47, 49, 258, 424, 428, 475  
 De Beer, Elmarie (E) | 479  
 De Beer, Stephan (S) | 364, 374, 424  
 De Jager, Tiaan (C) | 184  
 De Jongh, Derick (D) | 97, 107, 118, 489  
 Dekel, Eddie (E) | 120  
 Dekker, Nick (N) | 159  
 De Klerk, Antonie (AM) | 47, 178, 433, 518, 523  
 De Kock, Henriëtte (HL) | 306  
 De la Rey, Cheryl (CM) | 3, 6, 12, 13, 20, 21, 25, 46, 59, 84, 85, 87, 96, 150, 190, 257, 274, 315, 338, 380, 395, 405, 427, 428, 502, 503, 504, 507, 514, 524  
 Delpont, Piet (PA) | 289, 296  
 Delpont, Rhena (R) | 184, 208  
 Delpont, Rikus (R) | 497, 498  
 Delpont, Susan (SD) | 212  
 Devar, Managa (M) | 149  
 De Villiers, Carina (C) | 176  
 De Villiers, Etienne (DE) | 251, 364, 371  
 De Villiers, Gerda (G) | 373  
 De Villiers, Hettie (HH) | 495  
 De Villiers, Isolde (I) | 288  
 De Villiers, Pieter (P) | 176  
 De Waal, Marietjie (M) | 444, 445, 518  
 De Wet, Erika (E) | 278, 291, 292  
 De Wet, Francois (FA) | 194  
 De Wet, Gideon (G) | 178  
 Diale, Mmantsae (M) | 306, 348  
 Diamond, Roger (RE) | 332  
 Dick, Archie (AJ) | 149, 175, 177  
 Dijkman, Ronel (R) | 444, 445

Dippenaar, Lauritz (L) | 34  
 Djolov, George (GD) | 330  
 Dockrat, Riaaz (R) | 445  
 Dreosti, Lydia (LM) | 219  
 Dreyer, Greta (G) | 222, 223  
 Dreyer, Leonara (L) | 207  
 Dreyer, Wim (WA) | 370  
 Dreyer, Yolanda (Y) | 363, 374  
 Dube, Zoro (ZZ) | 372  
 Duffey, Alex (AE) | 264, 523  
 Dullabh, Hemant (HD) | 196  
 Dumont, Yves (Y) | 351  
 Duncan, Graham (GA) | 362, 370  
 Duncan, Neil (NM) | 391  
 Duncan, Norman (NTF) | 47, 49, 235, 236, 428, 518, 525  
 Du Plessis, Chrisna (C) | 149, 170, 172  
 Du Plessis, Esmé (ED) | 33  
 Du Plessis, Jan (JL) | 167  
 Du Plessis, Monuko (M) | 161  
 Du Toit, Jacques (J) | 174  
 Du Toit, Madeleine (M) | 91, 151, 164  
 Du Toit, Pieter (PH) | 146  
 Duvenhage, Rocco (R) | 336  
 Dyosi, Xabisa (X) | 444, 445  
 Dyson, Liesl (LL) | 329

## E

Eberlein, Eric (E) | 135  
 Ebersöhn, Liesl (L) | 132, 143  
 Ebrahim, Irum (I) | 445  
 Ehlers, Marthie (MM) | 218  
 Elbeiti, Ahmed (A) | 126  
 Eliastam, John (JLB) | 506  
 Ellero, Andrea (A) | 228  
 Eloff, Irma (I) | 131, 254  
 Eloff, Jan (JHP) | 85, 149, 175  
 Eloff, Kobus (JN) | 391  
 Elson, Joanna (JL) | 226  
 Els, Schalk (S) | 166  
 Emmambux, Naushad (NM) | 328  
 Engelbrecht, Andries (AP) | 152, 175, 176  
 Engelbrecht, Johann (J) | 303  
 Engelbrecht, Mariëtte (M) | 150  
 Engelbrecht, Sarah-Lee (SL) | 51  
 Erasmus, Alet (AC) | 327, 396  
 Erasmus, Carin (C) | 462  
 Erasmus, Lourens (LJ) | 318  
 Eriksson, Patrick (P) | 306, 332  
 Esterhuizen, Janine (J) | 52  
 Euthimiou, Louise (LMA) | 472  
 Evans, Chris (C) | 128  
 Evans, Rinelle (R) | 135, 146  
 Ewing, Mike (M) | 126

## F

Farolfi, Stefano (S) | 316  
 Fauconnier, Con (C) | 167

Ferguson, Willem (W) | 342  
 Ferreira, Jacques (J) | 50  
 Ferreira, Ronel (R) | 131, 135, 142, 143  
 Feucht, Ute (UD) | 185, 223, 226  
 Filmalter, Celia (C) | 200  
 Findlay, Ken (KP) | 342  
 Finkel, Hernan (H) | 497  
 Fioramonti, Lorenzo (L) | 91, 252, 253, 271, 507, 518  
 Fisher, Roger (RC) | 170  
 Focke, Walter (WW) | 157, 348  
 Fombad, Charles (CM) | 285, 291, 292, 293, 300  
 Forbes, Patricia (PBC) | 306, 326  
 Fosgate, Geoffrey (GT) | 389  
 Fouché, Colin (CC) | 479  
 Fourie, Bernard (B) | 218  
 Fourie, David (DJ) | 128  
 Fourie, Jeanine (J) | 196  
 Fourie, Willem (W) | 107, 117, 118, 364, 371  
 Frantz, José (JM) | 202  
 Fraser, William (WJ) | 134, 146  
 Frenzel, Karl (K) | 129  
 Frevel, Christian (C) | 373  
 Fritz, Carika (C) | 288

## G

Gaigher, Estelle (E) | 146  
 Ganswindt, André (A) | 342, 344, 345, 386  
 Garba, Salisu (SM) | 351  
 Garbers-Craig, Andrie (AM) | 165  
 Gardiner, Elize (E) | 50  
 Gardner, Cello (CI) | 449, 450  
 Gaspar, Anabella (ARM) | 320  
 Gates, Bill (B) | 328  
 Gerber, Leon (LJ) | 292  
 Gericke, Gerda (GJ) | 199  
 Gerwel, Jakes (GJ) | 4  
 Gettliffe, Mary-Ann (M) | 292  
 Geyer, Hendrik (HB) | 504  
 Geysler-Fouché, Ananda (A) | 373  
 Gilmore, Shirley (S) | 465  
 Gitau, Michael (MN) | 162  
 Goddard, Amelia (A) | 377, 386  
 Godwin, Andrew (A) | 297  
 Goetz, Annette (A) | 332  
 Goga, Ameena (AE) | 223  
 Goldberg, Theo (DT) | 504  
 Gomwe, Godfrey (G) | 165  
 Gourley, Brenda (B) | 20  
 Gouws, Daan (DG) | 123  
 Govender, Ansuya (A) | 446  
 Gräbe, Hannes (PJ) | 160  
 Graham, Margot (MS) | 201  
 Graham, Marien (M) | 143  
 Granova-Mooi, Olga (O) | 462  
 Grant, Rina (R) | 229  
 Gravett, Willem (W) | 290  
 Greeff, Ooppel (OBW) | 227  
 Green, Alida (A) | 53

Green, Robin (RJ) | 206, 226  
 Grimsehl, Uys (U) | 156  
 Grobler, Anské (AF) | 116  
 Grobler, Gerhard (G) | 231  
 Grobler, Jacomine (J) | 152  
 Groenewald, Alphonso (A) | 372, 373  
 Groenewald, Herman (HB) | 386  
 Grové, Niek (NJ) | 47, 50, 273, 292, 293, 294, 425, 433, 457, 462, 475, 525  
 Guldimann, Colette (C) | 249  
 Gupta, Rangan (IR) | 120, 121  
 Guthrie, Alan (AJ) | 381

## H

Hadebe, Xolani (X) | 453  
 Haese, Leo (LA) | 36  
 Hager, Johann (J) | 152  
 Hall, Grant (G) | 342  
 Hall, Stephan (SG) | 109  
 Hammerbacher, Almuth (A) | 342  
 Hancke, Gerhard (GP) | 152, 160, 161, 163  
 Hanekom, Tania (T) | 152, 161  
 Harms, Louis (LTC) | 289, 293, 295  
 Harpham, Geoffrey (G) | 507  
 Harris, Bernice (B) | 204  
 Harris, Karen (KL) | 53, 54  
 Harris, Teresa (T) | 138  
 Hartell, Cyclic (CG) | 131, 138, 272  
 Hart, Keith (K) | 506  
 Hassan, Rashid (RM) | 312, 313, 316  
 Hassen, Abubeker (A) | 318  
 Haupt, Franciscus (F) | 299  
 Hayward, Matt (MW) | 345  
 Hearn, John (JP) | 84  
 Heath, Ernie (E) | 126  
 Hefele, Sovashni (S) | 449  
 Hefer, Charles (CA) | 323  
 Heher, Jonathan (JA) | 48  
 Hendricks, Denver (D) | 88, 496, 497  
 Hendriks, Sheryl (SL) | 305, 312, 313, 315, 356  
 Hendriks, Stephen (S) | 207  
 Herbst, Deon (D) | 428, 430  
 Hermann, Lizette (L) | 300  
 Hertzler, Greg (G) | 316  
 Heyns, Christof (CJ) | 60, 91, 277, 278, 280, 285, 288, 292, 293, 300, 516, 518  
 Heyns, Stephan (PS) | 166  
 Heyns, Tanya (T) | 200  
 Hill, Colin (C) | 202  
 Hinkelman, Knut (K) | 177  
 Hlatshwayo, Thulani (TT) | 336  
 Hlongwa, Phumzile (P) | 195  
 Hlophe, Bongani (BM) | 449  
 Hoceped, Alain (AML) | 231  
 Hoeane, Masitha (M) | 264  
 Hoffman, Danie (D) | 173  
 Hoffman, Willem (WA) | 204  
 Holland, Kevin (K) | 128



Holm, Dietmar (DE) | 377  
 Holmes, Marcus (M) | 523  
 Holtzhausen, Natasja (N) | 128  
 Hoobler, Jenny (JM) | 105, 124, 125  
 Hoosen, Anwar (AA) | 218  
 Howie, Sarah (SJ) | 91, 147  
 Hugo, Annarie (GA) | 203  
 Hugo, Jannie (JF) | 186, 208, 214, 215  
 Huismans, Henk (H) | 320  
 Huls, Kathleen (K) | 297  
 Huls, Nick (N) | 297  
 Human, Dirk (DJ) | 360, 363, 372, 373, 375  
 Human-Vogel, Salome (S) | 131  
 Hurley, Brett (BP) | 342, 343  
 Hussey, Steven (SG) | 324

**I**

Inglesi-Lotz, Roula (R) | 121  
 Irons, Pete (P) | 388  
 Ismail, Mahjoub (MYA) | 213

**J**

Jackson, Brandon (BS) | 232  
 Jacobs, Frederik (FJ) | 193  
 Jacobs, Willem (WJ) | 291  
 Jacot-Guillarmod, Edouard (E) | 284  
 Jacyk, Witold (WK) | 213  
 Jansen, Jonathan (J) | 22  
 Janse van Rensburg, Christa (DCC) | 184, 229, 230  
 Janse van Rensburg, Christine (C) | 318  
 Janse van Rensburg, Elsie (ES) | 200  
 Javett, Michael (M) | 19, 524, 525  
 Johnson, Ensa (E) | 85  
 Jones, Liz (E) | 149  
 Jooste, Yvonne (Y) | 288  
 Jordaan, Danie (D) | 313, 317  
 Jordaan, Dolf (D) | 419, 422  
 Jordaan, Ronél (R) | 50  
 Jordaan, Yolanda (Y) | 126, 497  
 Jorissen, Willem (HW) | 483  
 Joubert, Annie (AM) | 228, 230, 336  
 Joubert, Fourie (F) | 323  
 Joubert, Ina (JC) | 135, 138  
 Joubert, Jody (J) | 147  
 Joubert, Johan (J) | 160, 161  
 Joubert, 'Ora (O) | 170, 523  
 Joubert, Pierre (PM) | 230  
 Joubert, Rika (HJ) | 141  
 Jourdain, Damien (D) | 316  
 Joynt, Corlia (C) | 113  
 Julien, Eileen (E) | 507

**K**

Kagwiza, Jean (JN) | 202  
 Kakaza, Mandisa (M) | 208  
 Kalaba, Mmatlou (M) | 317  
 Kanengoni, Herbet (H) | 124

Karama, Musafiri (M) | 391  
 Karuaihe, Selma (ST) | 316  
 Kauchali, Shuaib (S) | 222  
 Kavli, Haakon (HN) | 123  
 Kearsley, Elsabé (EP) | 159  
 Kebalepile, Moses (MM) | 207  
 Keet, André (A) | 21, 101  
 Keith, Mark (M) | 345  
 Kekana, Mable (RM) | 203  
 Kelly, Patricia (PJ) | 200  
 Kenoshi, Ernest (E) | 212  
 Keough, Natalie (N) | 211  
 Ker, James (JA) | 184, 217  
 Kgarosi, Kableo (K) | 465  
 Kgatla, Thias (ST) | 364, 375  
 Kgatle, Mahlodi (M) | 126  
 Kgekolo, Mahlatse (CM) | 213  
 Khumalo, Cyprian (C) | 51  
 Khunou, Grace (G) | 20  
 Kijko, Andrzej (A) | 332, 333  
 Kilfoil, Wendy (W) | 419, 421, 422  
 Killander, Magnus (UM) | 285  
 Kirova, Anna (A) | 135  
 Kirsten, Johann (JF) | 312, 313  
 Kisten, Vadhashnee (V) | 450  
 Kleffner, Jann (JK) | 292  
 Kleyn, Duard (D) | 288  
 Kleynhans, André (A) | 42  
 Kleyn, Nicola (N) | 395, 396, 403  
 Kloppenborg, John (JS) | 363  
 Kluyts, Hyla (H) | 209  
 Koch, Steven (SF) | 120, 121  
 Koekemoer, Eileen (FE) | 124  
 Kok, Anton (A) | 97, 277, 288  
 Kok, Kobus (JK) | 372  
 Koornhof, Carolina (C) | 18, 47, 49, 105, 425, 428, 445  
 Korsten, Lise (L) | 339, 356  
 Kotzee, Ninette (N) | 470  
 Kriegler, Johann (JC) | 284  
 Kriel, Carolyn (C) | 457  
 Kriel, Hilda (HAJ) | 465  
 Krige, Paul (PD) | 449, 450  
 Kritzinger, Dorette (D) | 194  
 Kruger, Candida (CCP) | 192  
 Krüger, Christa (C) | 231  
 Kruger, Jeanette (J) | 50  
 Kruger, Mariana (M) | 207  
 Krüger, Tjaart (TPJ) | 335  
 Kumar, Pushpam (P) | 316  
 Kungoane, Tsholofelo (T) | 195  
 Kupe, Tawana (T) | 46  
 Kuschke, Birgit (B) | 277, 294  
 Kuye, Jerry (KO) | 127  
 Kwakwa, Edward (E) | 284  
 Kweyama, Khanyisile (K) | 99

**L**

Labuschagne, Kobus (JP) | 370

Lafanechere, Laurence (L) | 230  
 Lakier, Roy (RH) | 231  
 Lall, Namrita (N) | 306, 339, 352, 353  
 Landman, Karina (K) | 174  
 Landman, Willem (WA) | 328, 329  
 Langa, Pius (P) | 92  
 Langner, Danie (D) | 99  
 Lartey, Emmanuel (EY) | 363  
 Laurens, Tim (TB) | 327  
 Lawal, Ismaheel (I) | 222  
 Leask, Rhoda (R) | 389  
 Lekgela, Moses (MM) | 449  
 Lekota, Cheizette (C) | 445  
 Lemmens, Juan-Claude (J) | 420, 422, 423  
 Lengana, Thabo (T) | 222  
 Lenhardt, Nils (N) | 332  
 Leonard, Louis (L) | 465  
 Le Roux, Jurie (JH) | 373  
 Le Roux, Marius (M) | 445  
 Le Roux, Wiida (W) | 472  
 Leshner, Alan (AI) | 515  
 Letsholo, Reba (RG) | 116  
 Leuschner, Wilhelm (FW) | 160  
 Ligthelm, At (AJ) | 190  
 Linden, Michal-Maré (M) | 25, 26, 487  
 Lindeque, Gerhard (BG) | 206, 207, 222, 223  
 Loader, James (JA) | 373  
 Lockhat, Zarina (ZI) | 231  
 Lombard, Riaan (R) | 194  
 Loots, Elsabé (E) | 105, 106, 110  
 Loubser, Michael (MJ) | 330  
 Louw, André (A) | 317  
 Louw, Braam (AI) | 323  
 Louw, Elbie (E) | 123, 124  
 Louw, Ina (I) | 334  
 Louw, Leane (L) | 292  
 Louw, Melanie (M) | 209  
 Lowies, Braam (GA) | 123  
 Lubbe, Berendien (BA) | 126  
 Lübbe, Willem (WJ) | 433  
 Lubuma, Jean (JMS) | 42, 303, 304, 305, 334, 350, 351  
 Lukhele, Mlungisi (M) | 462  
 Lundhede, Thomas (T) | 316  
 Lutermann, Heike (H) | 342

**M**

Maboko, Vongani (V) | 342  
 Machashu, Ayanda (A) | 318  
 Machethe, Charles (CL) | 312, 313  
 Machi, Sisana (TSF) | 426, 475  
 Madekurozwa, Mary-Catherine (MC-N) | 386  
 Madiba, Matete (NRM) | 419, 483, 484  
 Madiba, Thommy, (TK) | 192  
 Madlhophe, Sydney (S) | 300  
 Madlingozi, Tshepo (T) | 288, 300  
 Maharaj, Sunil (BTJ) | 91, 149, 150, 152, 153, 160, 162  
 Maharaj, Vinesh (V) | 325, 327  
 Mahlangu, Elijah (E) | 372

Mahlangu, Simon (SW) | 42  
 Mahlangu, Vimbi (V) | 135  
 Mahlangu, Zanele (Z) | 157  
 Majozi, Thokozani (T) | 91, 151, 152, 157  
 Makakavhule, Kundani (K) | 174  
 Makanjee, Chandra (CR) | 203, 204  
 Makgoba, Malegapuru (MW) | 101  
 Makgoba, Thabo (TC) | 361  
 Makhalanyaane, Thulani (TP) | 305  
 Makhura, Moraka (MN) | 313  
 Makulubele, Moganetsi (M) | 374  
 Makunyane, Prisilla (PMS) | 223  
 Malan, Francois (DF) | 170  
 Malan, Koos (JJ) | 291  
 Malebo, Samuel (S) | 225  
 Malherbe, Jan (J) | 150  
 Malherbe, Johan (JAG) | 162  
 Malherbe, Johan (JB) | 335  
 Maluleke, Tinyiko (T) | 496  
 Mamabolo, Honey (H) | 157  
 Mampane, Ruth (R) | 142  
 Mampane, Sharon (S) | 135  
 Manele, Isaiah (I) | 486  
 Mañes, Jordi (J) | 328  
 Manganyi, Chabani (NC) | 507  
 Manning, Dianne (D) | 184  
 Mans, Janette (J) | 219  
 Manyala, Ncholu (N) | 158, 336, 348  
 Marais, Dawie (DD) | 425, 426  
 Marais, Gert (G) | 509  
 Marcus, Tessa (TS) | 214  
 Maree, Carin (C) | 208  
 Maree, Kobus (JG) | 132, 133  
 Maree, Kobus (K) | 202  
 Maree, Leon (L) | 159  
 Maree, Tania (T) | 126  
 Mariba, Thanyani (TJ) | 184  
 Maritz, Tinus (MJ) | 149, 170, 172, 173  
 Marivate, Vukosi (V) | 175, 176  
 Markotter, Wanda (W) | 186, 220, 306, 320  
 Marnewick, Johan (J) | 196  
 Marsh, Susan (S) | 465  
 Masango, Maake (MJS) | 363, 374  
 Mashinini, Jabu (J) | 97  
 Mashungwa, Patience (P) | 95  
 Maslen, Stuart (S) | 292  
 Mathabathe, Kgadi (KC) | 326  
 Mathews, Pieter (PJ) | 525  
 Mathijs, Sophie (S) | 227  
 Mathopa, Abe (A) | 470  
 Matjila, Maila John (MJ) | 204, 206, 207  
 Matjila, Michael (M) | 150  
 Matjila, Tshepo (PT) | 377, 392  
 Matthee, Marianne (M) | 396  
 Mayaphi, Sim (S) | 219, 220  
 May, Julian (J) | 356  
 May, Kate (K) | 389  
 Mazabane, Brian (BN) | 225

Mbana, Benjamin (B) | 129  
 Mbazima, Norman (N) | 150  
 Mbeki, Thabo (T) | 15  
 Mbewe, Koketso (K) | 218  
 McCluskey, William (W) | 122  
 McCrindle, Cheryl (CME) | 391  
 McGaw, Lyndy (L) | 391  
 McIntyre, Una (UE) | 199  
 McKechnie, Andrew (A) | 342, 343, 353  
 Medalie, David (D) | 91, 247, 274  
 Meiring, Deon (D) | 124  
 Meiring, Jan (JH) | 207, 210  
 Meiring, Pieter (PGJ) | 361  
 Melck, Antony (AP) | 47, 48, 258, 457, 523, 524, 525  
 Merbold, Karl Heinz (K-H) | 208  
 Merensky, Hans (H) | 467  
 Meyer, Bern (BJ) | 222  
 Meyer, Debra (D) | 306, 320  
 Meyer, Josua (JP) | 149, 156, 166, 167  
 Meyer, Leith (LCR) | 381, 391  
 Meyer, Marion (JJM) | 338  
 Meyer, Pieter (PWA) | 216  
 Meyer, Sias (EE) | 373  
 Meylahn, Johann-Albrecht (JA) | 363, 374, 375  
 Mfolo, Tshepiso, (T) | 192  
 Milani, Lorenzo (L) | 332  
 Millar, Bob (RP) | 306  
 Millard, Daleen (D) | 294  
 Millard, Sollie (SM) | 342  
 Millar, Robert (RP) | 91, 342, 343, 344  
 Minnaar, Amanda (A) | 327, 328  
 Mizrachi, Eshchar (E) | 324  
 Mkhize, Boyce (B) | 204  
 Mmusi, Sheila Onkaetse (SO) | 99  
 Moche, John (MJ) | 213  
 Modiri, Joel (JM) | 288  
 Moen, Melanie (M) | 135, 138  
 Moerane, Rebene (R) | 377, 388  
 Mogale, Shirley (R) | 200  
 Mogotlane, Ramaranka (RA) | 47, 428  
 Mojola, Aloo (AO) | 373  
 Mokgokong, Sam (S) | 221  
 Mokgoro, Yvonne (M) | 97  
 Mokoduwe, Setsipane (S) | 470  
 Mokoena, Taole (TR) | 232  
 Molekoa, Phethedi (P) | 446  
 Moleko, Maggie (M) | 462  
 Moleleki, Lucy (LN) | 320  
 Molokane, Felicia (F) | 223  
 Moltmann, Jürgen (JD) | 364, 372  
 Monyepao, Lydia (L) | 493  
 Moolla, Naeem (N) | 444, 445  
 Moropa, Robert (R) | 465  
 Morris, Jane (EJ) | 323  
 Morris, Neil (NK) | 215  
 Mosala, Itumeleng (IF) | 373  
 Moshokoa, Evelyn (EM) | 233  
 Mosia, Themba (NT) | 45, 47, 48, 475, 484

Mostert, Pierre (P) | 126  
 Mostert, Roelf (RJ) | 164, 165  
 Mostert-Wentzel, Karien (K) | 202  
 Mothutsi, Jacob (J) | 465  
 Motlanthe, Kgalema (K) | 329  
 Motlhaolwa, Leepile (L) | 145  
 Motsitsi, Silas (NS) | 225  
 Mouton, Hugo (HJ) | 457, 459  
 Mphahlele, Matsimele (M) | 150  
 Mthembu, Thandwa (T) | 6  
 Mtoba, Futhi (NT) | 33  
 Muchiri, Jane (JW) | 199  
 Mulaudzi, Fhumulani (FM) | 197, 200  
 Mulaudzi, Mphele (M) | 223  
 Mulaudzi, Rendani (R) | 492  
 Mulaudzi, Thanyani (TV) | 232  
 Müller, Ernst (EW) | 232  
 Müller, Julian (JC) | 91, 363, 374, 506  
 Mungatana, Eric (E) | 313, 316  
 Murcott, Melanie (MJ) | 291  
 Murray, Wynand (W) | 207  
 Murungi, Nkatha (N) | 284  
 Mushungwa, Patience (TP) | 47, 428, 452  
 Mwenda, Kenneth (K) | 297  
 Myburgh, Cila (C) | 425  
 Myburgh, Hans (JG) | 224  
 Myburgh, Jean (JE) | 113  
 Myburg, Zander (AA) | 306, 324  
 Myers, Michael (MD) | 177  
 Mzamane, Mbulelo (MV) | 507  
 Mzilikazi, Kwezi (K) | 470

## N

Nagel, Chris (CJ) | 289  
 Nagel, Lizelle (L) | 213, 422, 423  
 Naidoo, Ana (A) | 131, 419, 420  
 Naidoo, Dhesighen (D) | 470  
 Naidoo, Sanushka (S) | 305, 324  
 Naidoo, Sharan (S) | 193  
 Naidoo, Vinny (V) | 377, 379, 382  
 Nambiar, Yogavelli (Y) | 402  
 Napier, John (JAL) | 167, 170  
 Naudé, Natasia (N) | 166  
 Ncube, Keith (K) | 228  
 Ndarana, Thando (T) | 329  
 Ndebele, Njabulo (NS) | 504  
 Ndogo, Sam (SS) | 373  
 Nel, Alewyn (JA) | 124  
 Nel, Johan (JSJ) | 428  
 Nell, Carlien (C) | 457  
 Nel, Malan (M) | 364, 374  
 Nel, Marguerite (M) | 465  
 Nel, Philip (PA) | 433  
 Nel, Sulette (S) | 195  
 Nemaston, Ronnie (R) | 449  
 Nene, Zozo (Z) | 223  
 Netshivhangani, Khuliso (K) | 202  
 Newton, Claire (CL) | 186

Newton-King, Nicky (N) | 124  
 Ngcamphalala, Celiwe (CA) | 354  
 Ngcelwane, Mthunzi (M) | 225  
 Ngoato, Refilwe (R) | 471  
 Ngoepe, Bernard (BM) | 109  
 Ngomane, Tsakani (T) | 313  
 Ngwena, Charles (CG) | 279, 285, 300  
 Ngwenyama, Ojelanki (OK) | 177  
 Nicholson, Caroline (CMA) | 47, 50, 52, 53, 288, 462, 496  
 Nicolson, Sue (S) | 342, 343  
 Nicol, Willie (W) | 152, 157  
 Niemandt, Nelus (CJP) | 360, 363, 375  
 Nieman, Giel (GH) | 116  
 Nienaber, Annelize (G) | 288, 291  
 Nienaber, Gerhard (G) | 129  
 Nieuwenhuisen, Jan (FJ) | 144  
 Nkabinde, Azile (A) | 113  
 Nkabinde, Bess (Y) | 284  
 Nkomo, Stella (SM) | 91, 105, 124, 125  
 Nkosi, Zakhele (ZH) | 332  
 Nkuhlu, Wiseman (LN) | 32  
 Nkuwkana, Thobela (T) | 318  
 Nkwana, Mapula (M) | 128  
 Noe, Pitso (P) | 204  
 Nolte, Madeleine (M) | 485  
 Nonkwelo, Carol (C) | 470  
 North, Christa (C) | 52, 457  
 Nsanzya, Brenda (B) | 465  
 Ntanjana, Maud (M) | 485  
 Nthontho, Maitumeleng (AM) | 85, 142  
 Nürnberger, Klaus (KB) | 364, 372  
 Nyakale, Suzy (S) | 465  
 Nyika, Aceme (A) | 470  
 Nzimande, Blade (B) | 5, 17, 96, 101, 187

## O

Oberholster, Johan (JGI) | 105, 113  
 Oberholzer, Ruanda (R) | 128  
 Odendaal, Wimpie (JW) | 161, 162  
 Ogina, Teresa (T) | 135  
 Ogude, James (J) | 504, 505, 506, 507  
 Ogude, Nthabiseng (NA) | 305, 405, 419, 423, 428  
 Olckers, Chantal (C) | 124  
 Olivier, Elsabé (E) | 465  
 Ololade, Kehinde (OK) | 222  
 Olorunju, Steve (S) | 202  
 Omidire, Funke (F) | 143  
 Onwu, Gilbert (G) | 146  
 Oost, Ebo (E) | 123  
 Oosthuizen, Carel (CJ) | 342  
 Oosthuizen, Izak (IJ) | 141  
 Oosthuizen, Marie (M) | 445  
 Oosthuizen, Marinda (MC) | 377  
 Oosthuizen, Nikki (NM) | 212  
 Oosthuizen, Wessel (WJ) | 433, 434  
 Oranje, Mark (MC) | 174  
 Otto, Eckart (E) | 373  
 Ouifki, Rachid (R) | 351

Ouma, Gerald (GW) | 457  
 Ozah, Karabo (RL) | 294

## P

Parker, Diane (D) | 5  
 Paruk, Fathima (F) | 212  
 Pasco, Allen (A) | 449  
 Paterson, Adi (A) | 323  
 Patten, Chrisopher (CF) | 109  
 Pattinson, Bob (RC) | 185  
 Pauly, Peter (PH) | 109  
 Pauw, Christoff (C) | 162  
 Pearson, Gail (G) | 297  
 Pelsler, Ruan (R) | 51  
 Pepper, Michael (M) | 91, 185, 217  
 Perkins, Brian (BK) | 140  
 Pettay, Ken (K) | 389  
 Petzer, Daniel (DJ) | 396  
 Peu, Dorricah (MD) | 200  
 Phatudi, Nkidi (NC) | 138  
 Phulukdaree, Alisa (A) | 230  
 Pidduck, Teresa (T) | 129  
 Pienaar, Elizabeth (EF) | 346  
 Pienaar, Heila (H) | 465  
 Pieterse, Fourie (F) | 171  
 Pieterse, Inge (I) | 173  
 Pilcher, Lynne (LA) | 306, 326  
 Pillay Jerry (J) | 359, 360, 362, 366, 367, 370  
 Pillay, Mayuri (MM) | 300  
 Pillay, Nelishia (N) | 175, 176  
 Pillay, Tahir (TS) | 212, 213  
 Pimm, Stuart (S) | 347  
 Pistorius, Calie (CWI) | 46, 523  
 Pistorius, Chris (PC) | 165  
 Plant, Kato (K) | 115  
 Pool, Roger (R) | 216  
 Postma, Corné (TC) | 208  
 Potgieter, Coenie (C) | 53  
 Potgieter, Johan (J) | 208, 492, 493  
 Potgieter, Marietjie (M) | 303  
 Potgieter, Nicoline (N) | 194  
 Powell, Estie (E) | 150  
 Preisig, Oliver (O) | 232  
 Pretorius, Elizabeth (E) | 497  
 Pretorius, Jakkie (JA) | 453  
 Pretorius, Jan (JP) | 212  
 Pretorius, Jannie (J) | 327  
 Pretorius, Marius (M) | 117  
 Pretorius, Resia (R) | 230  
 Pretorius, Sian (S) | 53  
 Pretorius, Suzaan (S) | 149  
 Pretorius, Tinus (MW) | 149, 178  
 Pretorius, Tyrone (TB) | 47, 457  
 Prinsloo, Hendrik (HF) | 152, 172  
 Prochner, Larry (L) | 135  
 Prozesky, Leon (L) | 391  
 PUNCHOO, Rivak (R) | 213  
 Puth, Gustav (G) | 126

**Q**

Qoko, Thozama (T) | 150  
Qumza, Thabang (T) | 471

**R**

Radhakrishnan, Shankara (SG) | 326  
Rakitianski, Sergei (SA) | 336  
Ramaahlo, Maria (M) | 486  
Ramagole, Maki (M) | 229  
Ramano, Enos (R) | 201  
Ramosé, Mogobe (MB) | 288  
Ramoutar-Prieschl, Rakeshnie (R) | 470  
Ramphele, Mamphela (M) | 20  
Rand, Brian (B) | 152, 157, 348  
Rantloane, Arthur (JLA) | 184, 208  
Rautenbach, Hannes (CJdW) | 328  
Rautenbach, Victoria (V-J) | 329, 330  
Reddy, Vasu (V) | 235, 236, 237, 238, 530, 531  
Reinecke, Jan (J) | 444, 445  
Rendall-Mkosi, Kirstie (K) | 205, 206  
Renke, Stéfan (S) | 289  
Rensburg, Ronel (RS) | 126  
Retief, Johan (JH) | 217  
Reva, Oleg (O) | 323, 324  
Reyers, Michelle (M) | 123, 124  
Reyneke, Mignon (M) | 126  
Rheeder, Paul (P) | 199, 206, 227  
Riley, Darren (DL) | 326  
Robinson, Dandalene (D) | 174  
Robinson, Peter (PH) | 318  
Roca, Alfred (AL) | 347  
Roduner, Emil (E) | 325  
Roestoff, Melanie (M) | 289  
Römer, Thomas (T) | 373  
Roos, Louw (JL) | 230  
Rosslyn-Smith, Wesley (W) | 116  
Rossouw, Seugnette (S) | 200  
Rossouw, Theresa (T) | 223  
Roux, Jolanda (J) | 306  
Roux, Polla (P) | 223  
Rowher, Egmont (ER) | 306, 325, 327  
Rudman, Elsie (EP) | 201

**S**

Saayman, Gert (GG) | 215  
Sagahutu, Jean Baptiste (JB) | 202  
Sandenbergh, Roelf (RF) | 149, 162, 165  
Sandwith, Corinne (C) | 249  
Satgoor, Ujala (U) | 465  
Sathekge, Mike (MM) | 221, 222  
Sauer, Nico (N) | 504  
Sauthoff, Marion (M) | 523  
Saville, Adrian (AD) | 401  
Schaap, Pieter (P) | 124  
Schaling, Eric (E) | 123  
Schmulian, Astrid (A) | 113  
Schmulow, Andy (A) | 297

Schneidermann, Ben (BA) | 177  
Schoeman, Dawie (D) | 156  
Schoeman, Johan (JP) | 386  
Schoeman, Linda (L) | 483  
Schoeman-Malan, Linda (MC) | 290  
Schoeman, Maxi (M) | 91, 235, 252, 530  
Schoeman, Niek (NJ) | 105  
Schoeman, Renate (R) | 201  
Scholtz, Clarke (CH) | 342, 343  
Schönfeldt, Hettie (HC) | 84, 85, 356  
Schubert, Wolf Dieter (WD) | 320, 327  
Schüssler, Mike (M) | 129  
Schutte, Clara-Maria (C-M) | 220  
Schwellnus, Martin (MP) | 91, 185, 228, 230  
Scott, Johan (TJ) | 290  
Sebothoma, Sam (S) | 150  
Sehoole, Chika (CT) | 131, 132, 135, 140  
Sekobelo, Makgabo (MP) | 450  
Selahle, Solly (S) | 232  
Selyshchev, Pawel (P) | 336  
Senkubuge, Flavia (F) | 206, 207  
Serem, June (JC) | 211  
Serote, Wally (MW) | 507  
Shaik, Shoayeb (S) | 195  
Shapiro, Henry (HP) | 212  
Sharp, John (S) | 235, 245, 246  
Sharp, Philip (PA) | 515  
Shingange, Rimbilana (R) | 318  
Shipalana, Rebecca (R) | 150  
Shongwe, Jeremiah (JBZ) | 99  
Shrader, Adrian (AM) | 342  
Siboto, Sylvester (S) | 470  
Sidebe, Heather (MH) | 199  
Siglé, Thys (T) | 173  
Sihlali, Bafana (BH) | 202  
Simelane, Ayanda (A) | 445  
Simmonds, Katherine (KE) | 200  
Simulane, Musa (M) | 317  
Singh, Smeetha (S) | 519  
Sithole, Fortune (FM) | 391  
Siwela, Anna (A) | 465  
Skelton, Ann (AM) | 278, 280, 290, 291, 293, 294, 295, 297, 298, 431  
Skinner, John (JD) | 344  
Skosana, Israel (IB) | 35  
Slabbert, Elzanie (E) | 38  
Slavik, Thomas (TT) | 210  
Slippers, Bernard (B) | 306, 513, 515, 516, 518, 520  
Small, Adam (A) | 99  
Small, Johan (J) | 129  
Smal, Pieter (P) | 144  
Smit, Ansie (A) | 332, 333  
Smit, Denise (D) | 149  
Smith, Edwin (ET) | 21, 24, 97, 405, 412  
Smith, Francois (FJ) | 209  
Smith, Peter (PW) | 389  
Smith, Rulaine (R) | 201  
Smit, Patricia (P) | 470

Smulders, Sharon (SA) | 129  
Smuts, Izelle (I) | 226  
Snyman, Leon (LC) | 223  
Snyman, Willem (WD) | 190  
Sofala, Nthabiseng (NJ) | 192  
Sole, Catherine (CL) | 342  
Soma-Pillay, Priya (P) | 223  
Somers, Michael (MJ) | 342, 345  
Sonn, Julian (J) | 97  
Soudien, Crain (C) | 94  
Southey, Ed (E) | 525  
Speckman, McGlory (MT) | 42, 372, 483, 484  
Spies, Brinton (BM) | 450  
Spijkerman, Sandra (S) | 209  
Spiteri, William (W) | 167, 170  
Squelch, Joan (JM) | 141  
Stadler, Piet (P) | 386  
Stanz, Karel (KJ) | 124, 125, 449  
Steenkamp, Emma (E) | 354  
Steenkamp, Vanessa (V) | 227, 228  
Steennot, Reinhard (R) | 297  
Stevens, Philip (GP) | 291  
Steyl, Johan (JCA) | 392  
Steyn, Gert (GJ) | 360, 363, 372  
Steyn, Maryna (M) | 185, 211  
Steyn, Miemsie (MG) | 138  
Steyn, Riana (RA) | 176  
Steyn, Theuns (TL) | 128  
Steyn, Wynand (WJvdM) | 159, 527  
Stiglingh, Madeleine (M) | 113, 128  
Stols, Gerrit (G) | 146, 419, 421  
Strasheim, Arien (C) | 124  
Strauss, Conrad (C) | 524  
Ströh, Anton (A) | 47, 49, 270, 303, 310, 338, 433, 457, 496, 518  
Strydom, Bronwyn (BL) | 53  
Stumpf, Waldo (WE) | 164, 165  
Sukdaven, Maniraj (M) | 375  
Sundermeier, Theo (THO) | 364  
Sutcliffe, Toby (T) | 493  
Swanepoel, De Wet (DW) | 91, 264, 431  
Swanepoel, Frederick (F) | 361  
Swan, Gerry (GE) | 377, 381  
Swart, Johan (J) | 323  
Sykes, Leanne (LM) | 190, 196  
Symes, Steven (SA) | 211

**T**

Takawira, Farirai (F) | 226  
Taole, Nthabiseng (N) | 470, 471  
Tau, Dorothy (D) | 149  
Taute, Helena, (H) | 211  
Taylor, John (JRN) | 305, 328  
Taylor, Maureen (MB) | 186, 219, 220  
Terblanche, Alta (AJ) | 226  
Terblanche, Andries (A) | 109  
Terblanche, Rian (R) | 256  
Terreblanche, Solomon (SJ) | 109  
Tesner-Smith, Desirée (D) | 42

Thanyani, Simon (S) | 471  
Theron, Anne (AE) | 230  
Theron, Annette (AJ) | 217  
Theron, Chris (CC) | 335, 336  
Theron, Joji (J) | 208  
Theron, Linda (LT) | 132, 143  
Theron, Marcel (MF) | 433  
Thomas, Philip (P) | 288  
Thompson, Peter (PN) | 389  
Thorlacious, Hendrik (H) | 232  
Throop, Henry (HB) | 335  
Till, Christopher (C) | 524, 525  
Tintinger, Greg (GR) | 212, 217  
Tisdale, Leonora (LT) | 363  
Tladi, Dire (D) | 278, 280, 288, 291, 292, 293, 294  
Tordiffe, Adrian (ASW) | 391  
Trahar, Sheila (S) | 506  
Treadwell, Ina (I) | 184  
Truscott, Adele (A) | 445  
Tshifularo, Mashudu (MI) | 225  
Tshiyoyo, Michel (MM) | 128  
Turner, Astrid (AC) | 208  
Turnovsky, Stephen (S) | 120

**U**

Urimubenshi, Gerard (G) | 202  
Usue, Emmanuel (EO) | 373  
Uys, Andre (A) | 195  
Uys, Johann (J) | 168  
Uys, Kitty (CJE) | 201

**V**

Vally, Zunaid (ZI) | 194  
Van Aswegen, Annel (A) | 449, 450, 523  
Van Dalen, Dalene (D) | 462  
Van Dam, Paul (PEA) | 377  
Van den Heever, Christo (C) | 445  
Van der Merwe, Alta (AJ) | 149, 176  
Van der Merwe, Ludolf (PL) | 433, 434  
Van der Merwe, Maynard (M) | 462  
Van der Merwe, Ria (R) | 53  
Van der Walt, André (AJ) | 212, 288  
Van der Walt, Johan (J) | 288  
Van der Walt, Kobus (K) | 492, 493  
Van der Wath, Annatjie (A) | 200  
Van der Watt, Jan (J) | 372  
Van der Westhuizen, Johann (JV) | 36, 99, 284, 288, 489  
Vandeyar, Saloshna (S) | 132, 135, 144, 146  
Van Eck, Ernest (E) | 363, 372  
Van Eck, Stéfan (BPS) | 277, 288, 289, 293, 296  
Van Eeden, Heidi (H) | 171  
Van Eeden, Jeanne (J) | 259, 524  
Van Heerden, Corlia (CM) | 289, 292, 293, 296, 297  
Van Heerden, Gene (G) | 126  
Van Heerden, Hennie (HHG) | 172  
Van Heerden, Jan (JH) | 105, 120  
Van Heerden, Willie (WFP) | 194, 195

Van Marle, Karin (K) | 277, 287, 288  
 Van Marle-Köster, Esté (E) | 318, 319  
 Van Niekerk, Gernia (G) | 421  
 Van Onselen, Charles (C) | 91, 250, 506, 507  
 Van Papendorp, Dirk (DH) | 228, 336  
 Van Rooijen, Tania (AJ) | 202  
 Van Schalkwyk, Henco (CH) | 123  
 Van Schoor, Albert (AN) | 210  
 Van Warmelo, Paul (P) | 288  
 Van Wyk, Candice (C) | 192  
 Van Wyk, Flip (PJ) | 190, 191  
 Van Wyk, Linda (L) | 497, 499  
 Van Wyk, Neltjie (NC) | 200  
 Van Zyl, Johan (J) | 395  
 Van Zyl, Johan (J) | 34, 306  
 Van Zyl, Leanne (L) | 470  
 Van Zyl, Louis Jacobus (LJ) | 145  
 Veldsman, Daniël (DP) | 360, 364, 371  
 Vellem, Vuyani (VS) | 364, 371  
 Venketsamy, Roy (T) | 135  
 Venter, Elmar (ER) | 114, 129  
 Venter, Fanus (SN) | 320  
 Venter, Jan (JA) | 345  
 Venter, Marietjie (M) | 220  
 Venter, Marli (M) | 310, 311  
 Venter, Piet (PM) | 363, 372  
 Venter, Rykie (R) | 486  
 Vermeulen, Els (E) | 342, 346  
 Vermeulen, Julene (J) | 465  
 Verschoor, Jan (JA) | 320  
 Viegi, Nicola (N) | 107, 120, 123  
 Vilakazi, Nokuthula (N) | 520  
 Viljoen, Altus (A) | 509  
 Viljoen, Frans (F) | 91, 277, 284, 285, 288, 293, 300  
 Viljoen, Michelle (M) | 32, 95  
 Vil-Nkomo, Sibusiso (S) | 47, 428  
 Visagie, John (J) | 471, 497  
 Vis, Ingrid (I) | 342  
 Visser, Alex (AT) | 159  
 Visser, Carina (C) | 319  
 Visser, Roelf (R) | 475  
 Vleggaar, Robert (R) | 325  
 Vogel, Coleen (C) | 518  
 Vogler, Gerliza (GE) | 457  
 Vorster, Francois (LF) | 449, 450  
 Vorster, Mariza (M) | 222  
 Vorster, Martin (M) | 194  
 Vorster, Quintus (Q) | 113, 445  
 Voyi, Kuku (K) | 204, 206  
 Vukea, Philia (PR) | 43

**W**

Wall, Kevin (K) | 152, 173, 174  
 Walters, Nadine (NM) | 310  
 Wannenburg, Johann (J) | 166  
 Ward, Michael (M) | 396  
 Warren, Nichola (N) | 194  
 Webb, Edward (EC) | 303, 318, 319  
 Webber, Lynne (LM) | 219  
 Webber-Youngman, Ronny (R) | 152, 167  
 Weber, Everard (KE) | 140  
 Weke, Patrick (P) | 312  
 Weldon, Chris (CW) | 342, 343  
 Welz, Stephan (S) | 524  
 Wenhold, Friedenborg (F) | 199  
 Wepener, Cas (CJ) | 360, 363, 374, 375  
 Wheeler, Melodie (M) | 470, 472  
 White, George, (JG) | 190, 192  
 White, Lyal (L) | 401  
 White, Zelda (Z) | 199  
 Wiese, Melanie (M) | 126  
 Wiggins, Harry (H) | 334  
 Wilken, Rina (EC) | 487  
 Wilkinson, Christopher (C) | 342  
 Willemse, Carel (C) | 25, 487  
 Williams, Christine (CA) | 449  
 Wilson, Jenny (JAG) | 231  
 Wingfield, Brenda (BD) | 303, 305, 306, 320, 348, 349, 354  
 Wingfield, Mike (MJ) | 305, 306, 354, 509, 513  
 Wittenburg, Dankwaard (DF) | 226

**X**

Xia, Xiaohua (X) | 91, 152, 161, 162

**Y**

Yadavalli, Sarma (VSS) | 152, 163  
 Yiallitsis, Georgia (G) | 150  
 Yusuf, Abdullahi (AA) | 342, 351

**Z**

Zhang, Lijun (L) | 162  
 Zietsman, Johan (J) | 166  
 Zilitinkevich, Sergei (S) | 330  
 Zimper, Alexander (A) | 121  
 Zoubos, Costas (K) | 336  
 Zulch, Benita (B) | 172  
 Zulu, Nonhlanhla, (N) | 462  
 Zuma, Jacob (J) | 10, 11, 26, 48, 412, 499